

Fundamentals of Computer Systems

Memory

Timothy K Paine

Columbia University

Summer 2022

Memory Architecture

Memory Cell Technologies

Programmable Logic Devices

Memory Architecture

Memory Interface

Data stored in *word* units

A word is several bytes (powers of two are typical)

write operations store data to memory

read operations retrieve data from memory

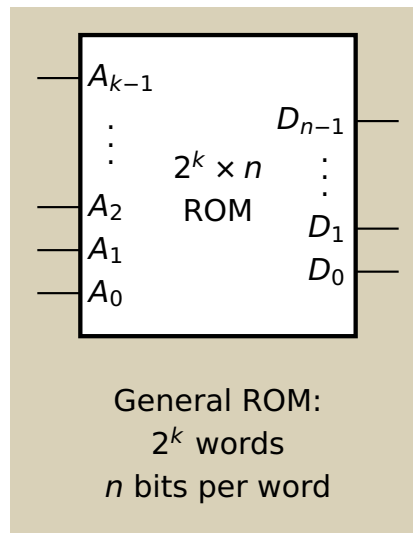

Conceptual View of Memory

Memory is an array of *cells*.

Each cell stores a single bit.

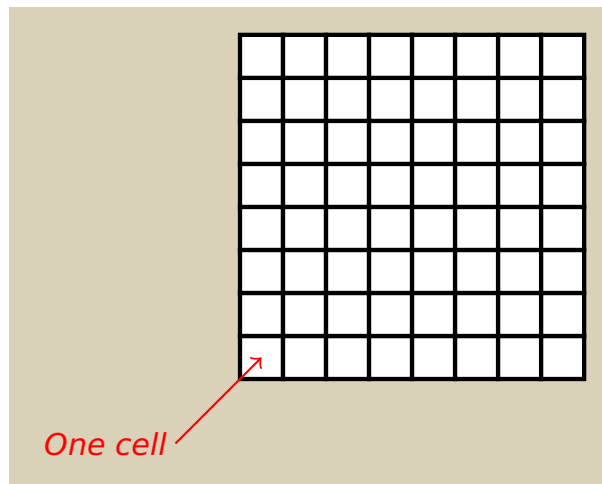

Cell Behavior

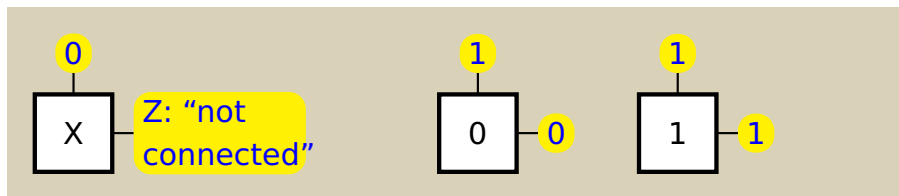
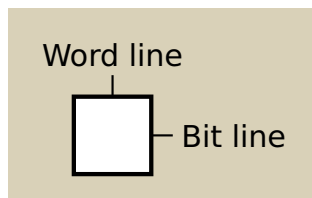

Implementation of cell depends on type of memory.

Generic Memory Array Architecture

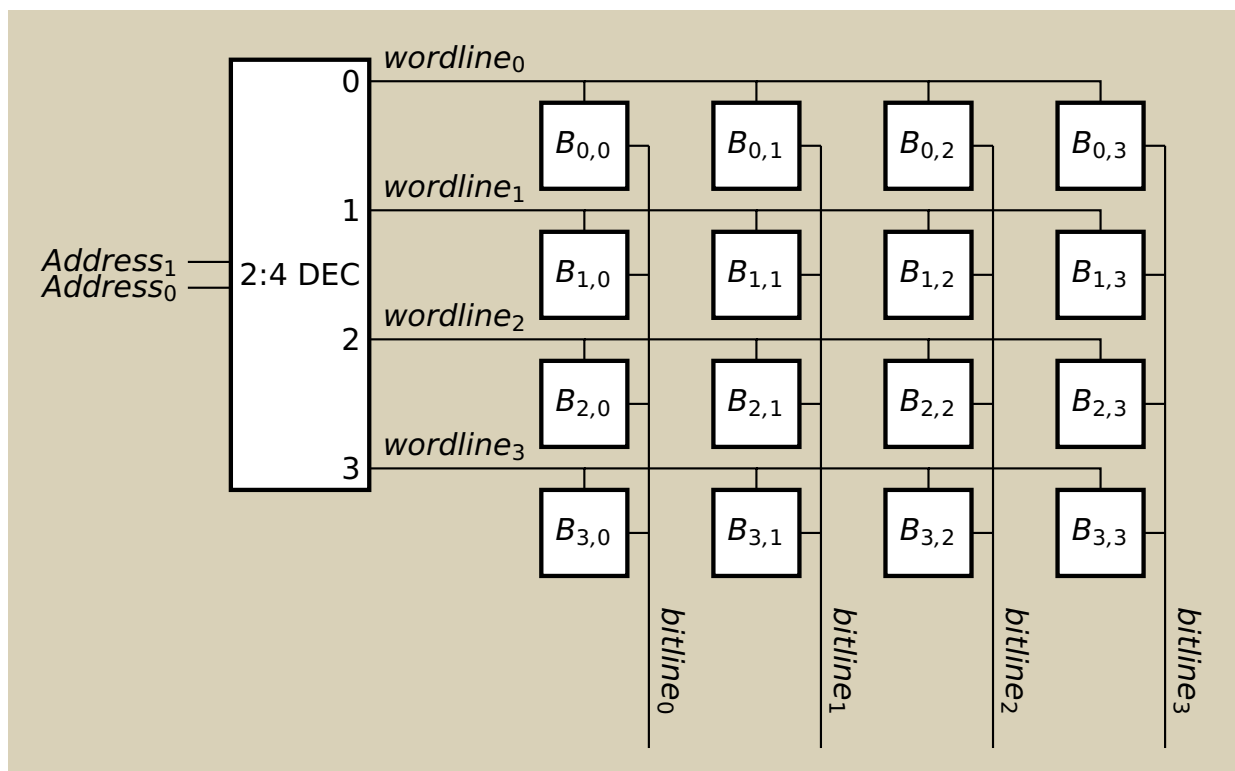

Generic Memory Array Architecture

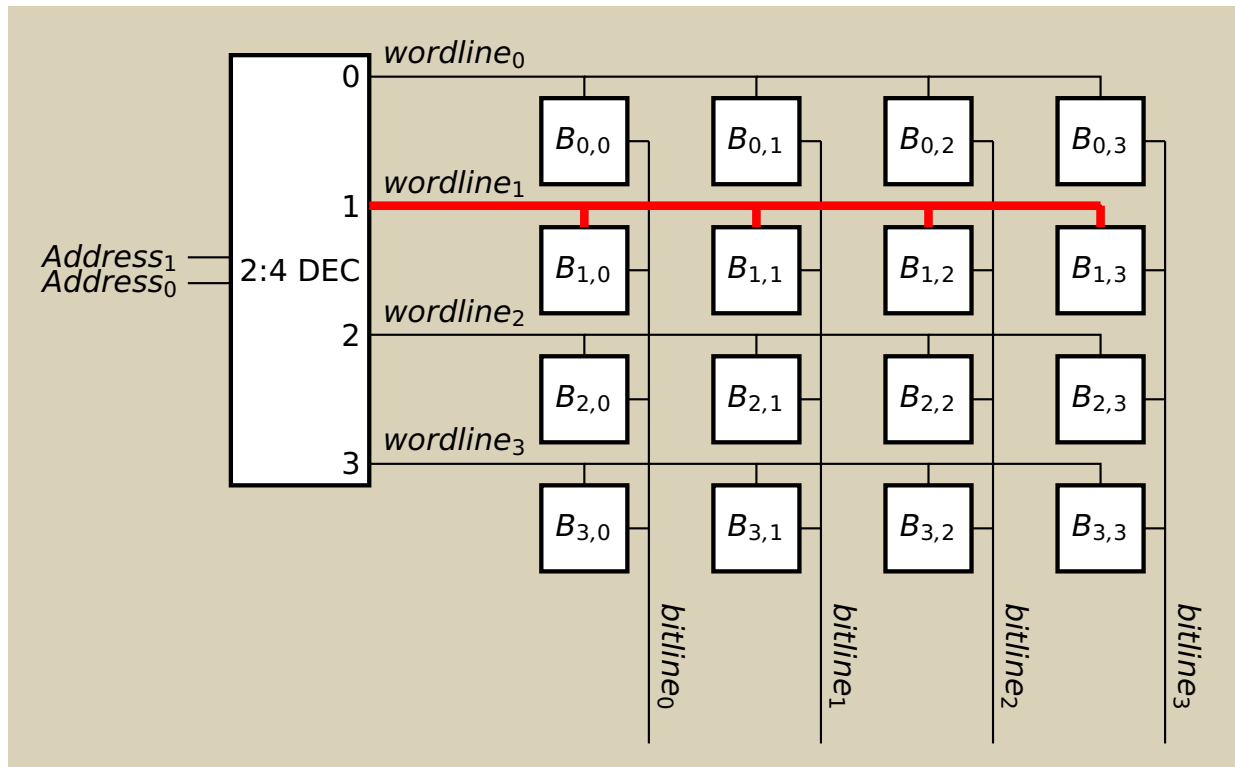

Address is decoded into set of wordlines.

Wordlines select row to be read/written.

Only one wordline=1 at a time.

Generic Memory Array Architecture

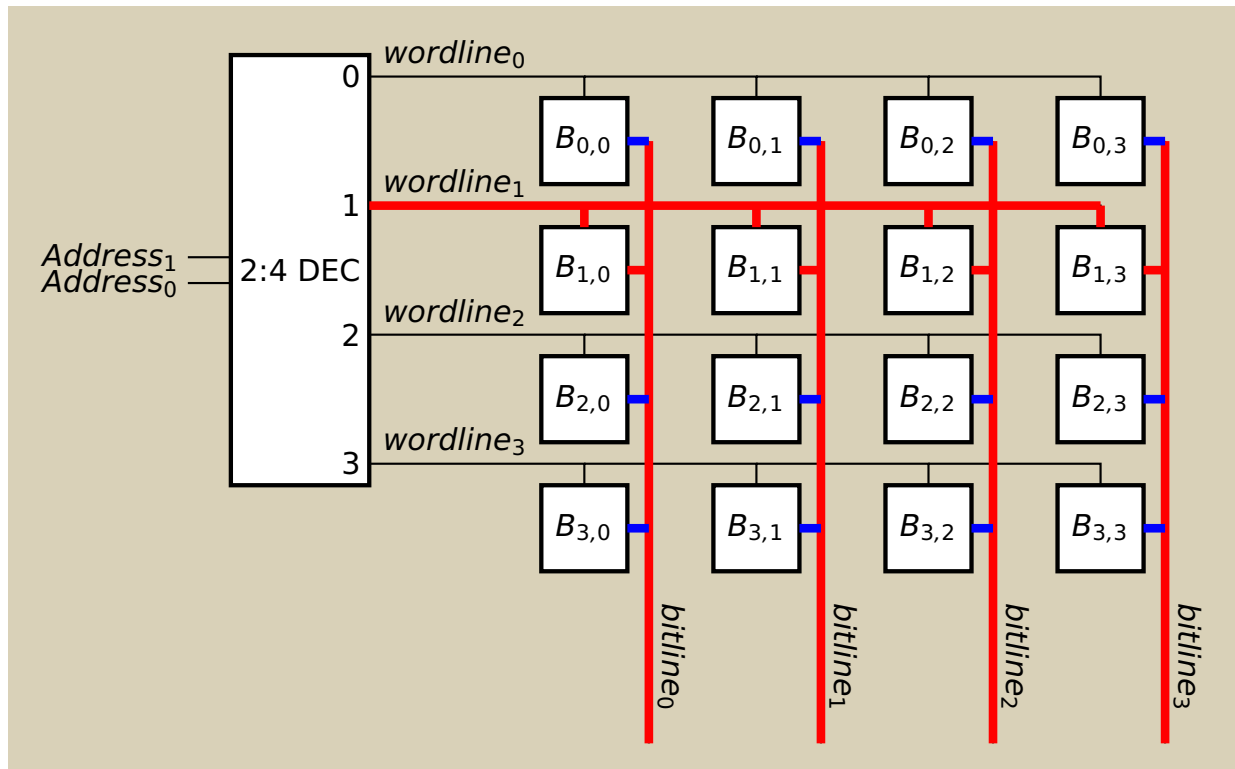

Multiple cells read in parallel, setting values of multiple bitlines.

Coincident Selection Saves Decode Logic

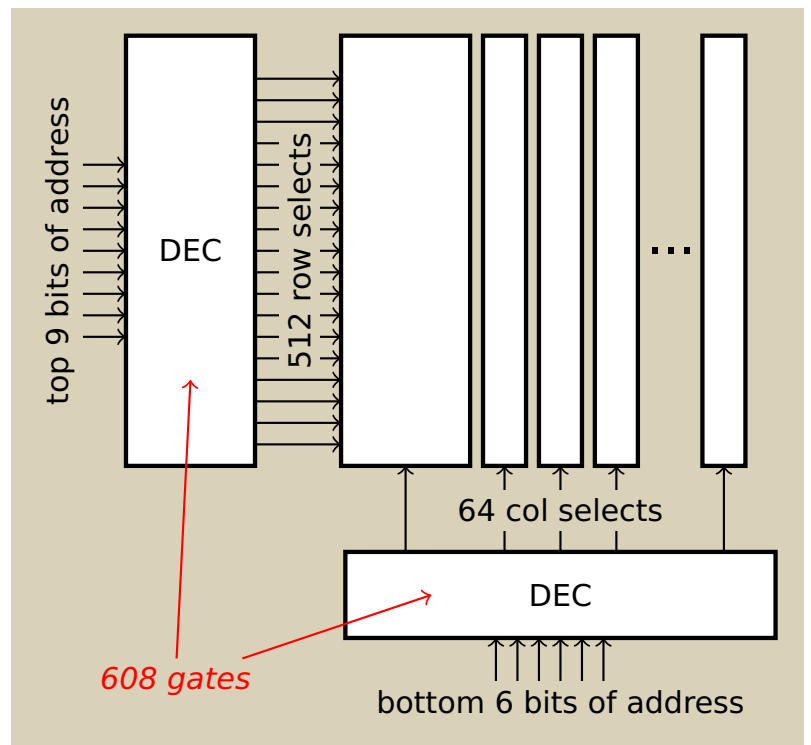
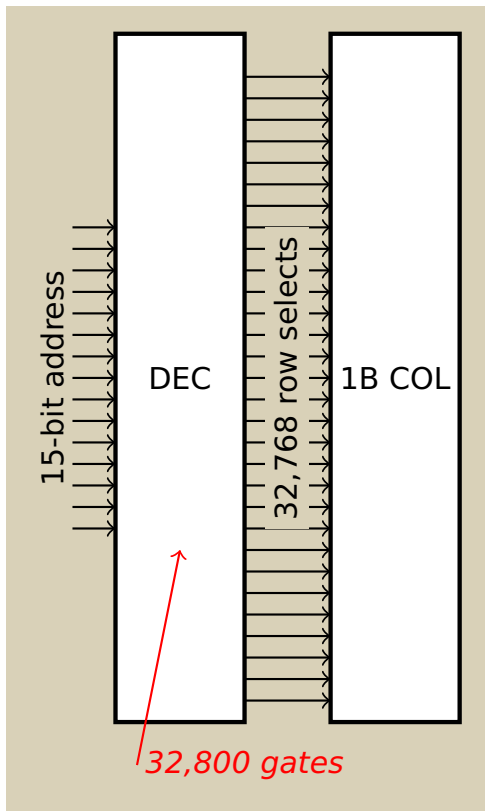

Memory Cell Technologies

Static Random-Access Memory Cell (SRAM)

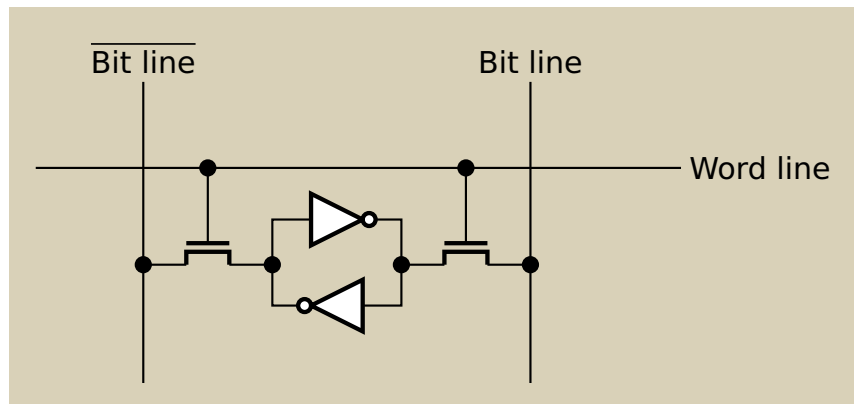

Dynamic RAM Cell

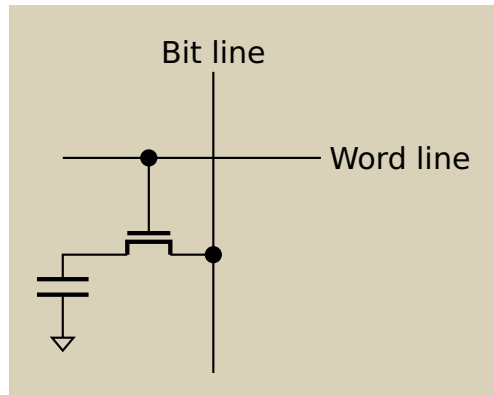

CMOS Mask-Programmed ROMs

Add. Data	
00	011
01	110
10	100
11	010

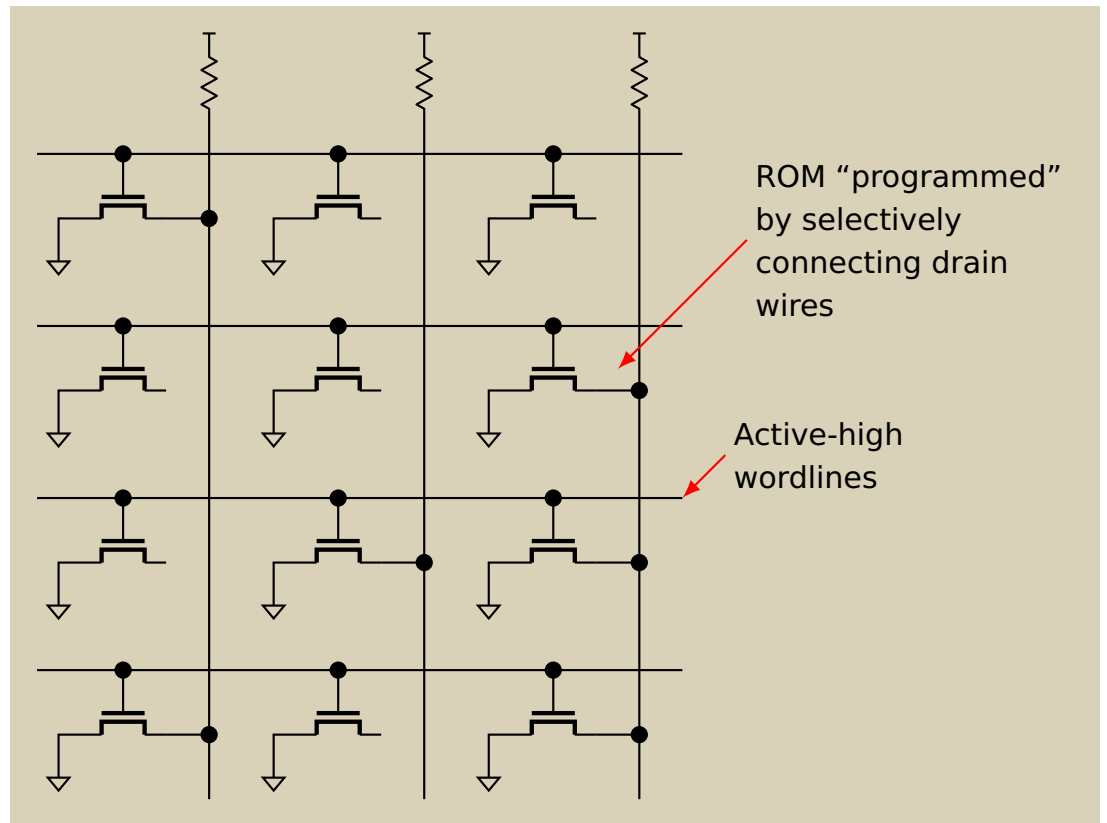

EPROMs and FLASH use Floating-Gate MOSFETs

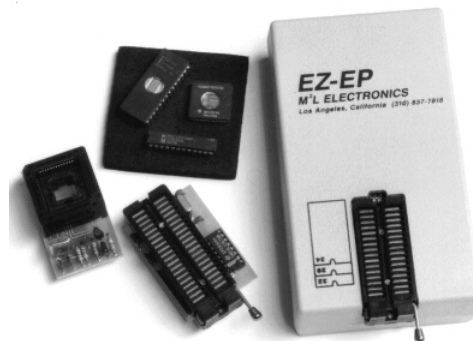
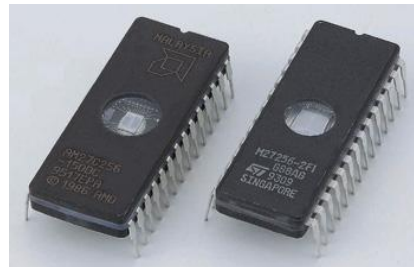
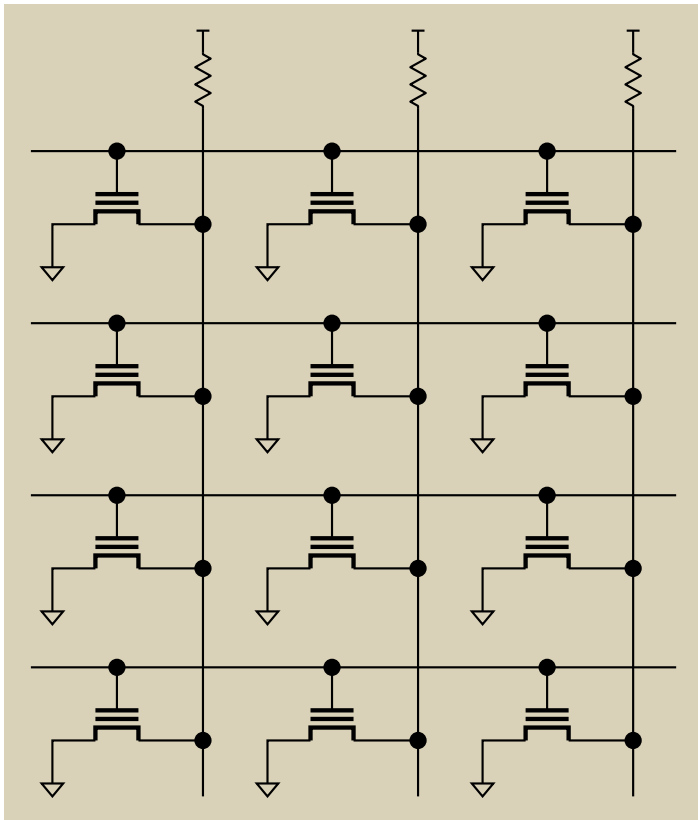

Volatile Storage Comparisons

	Flip-Flop	SRAM	DRAM
Transistors/Bit Density	Approx. 20 Low	6 Medium	1 High
Access Time	Fast	Medium	Slow
Destructive Read?	No	No	Yes ¹
Power	High	Medium	Low

¹Therefore refresh required

Programmable Logic Devices

Atari Space Race, 1973

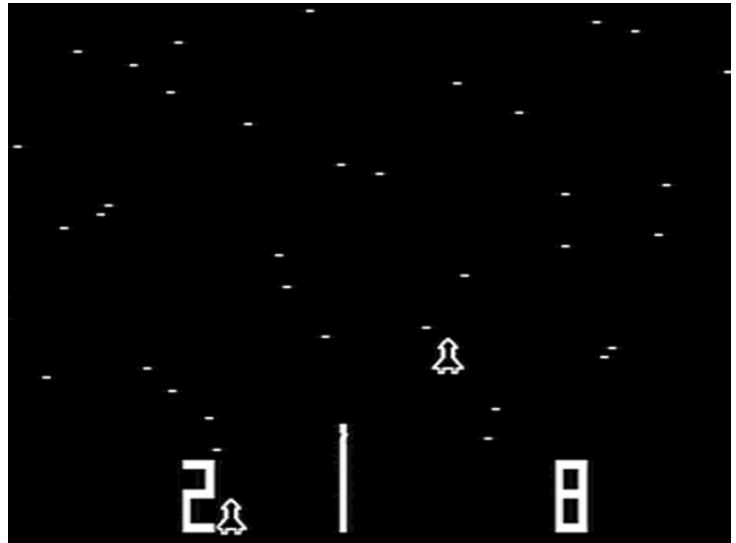
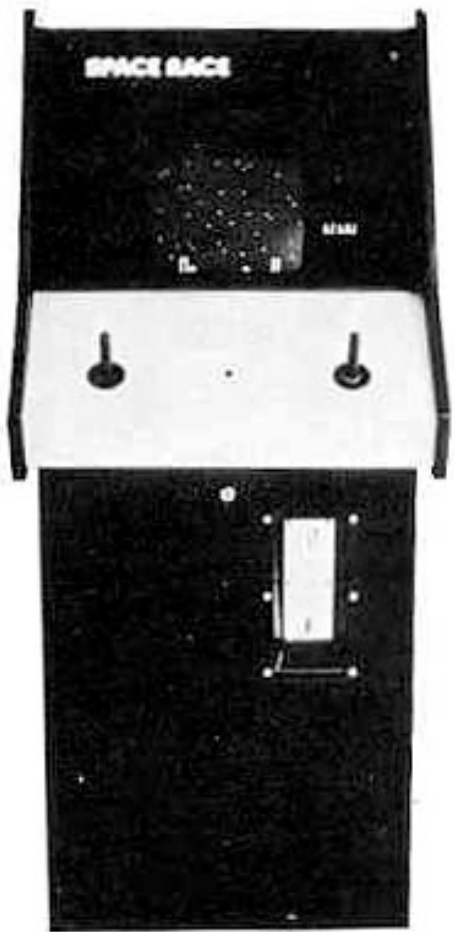

Atari Space Race PCB

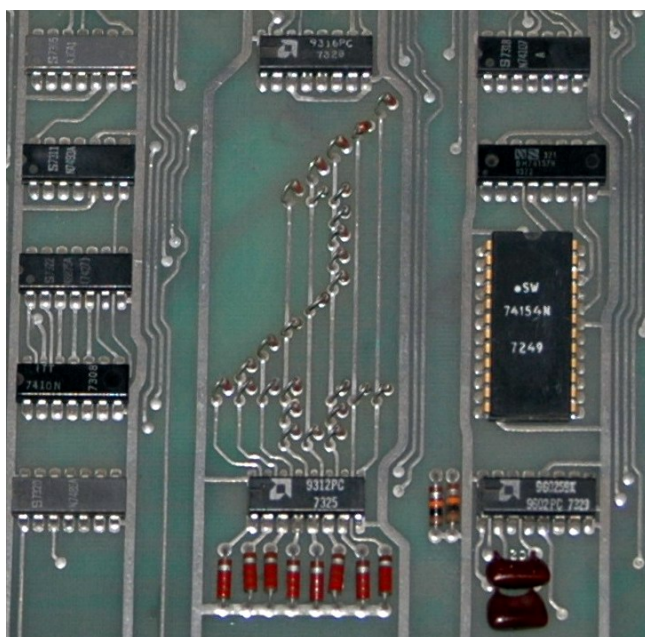

Front

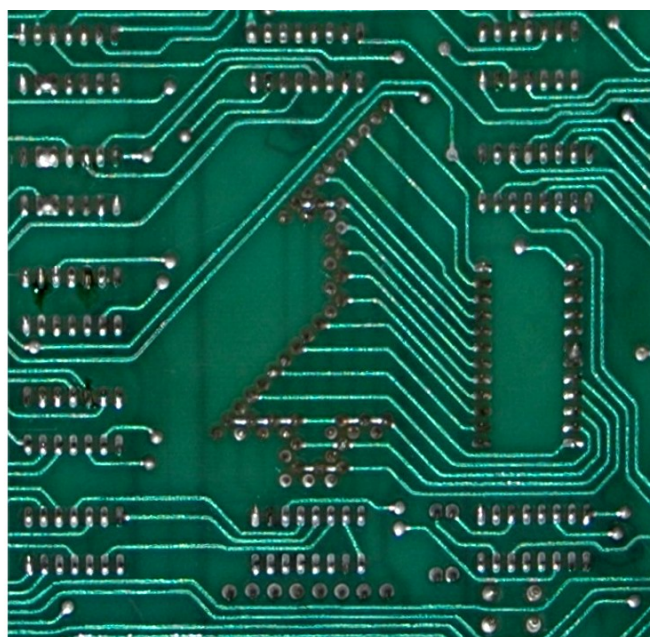

Back (mirrored)

The Space Race ROM

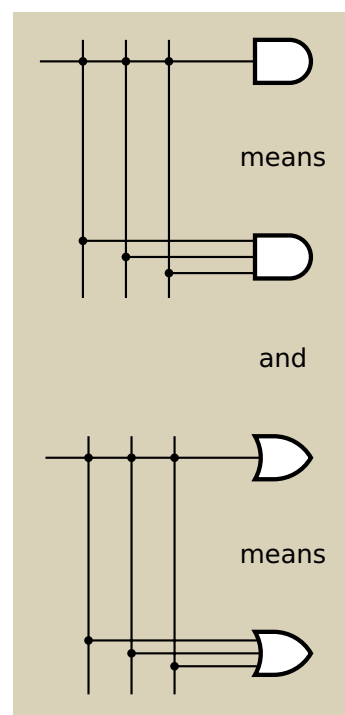
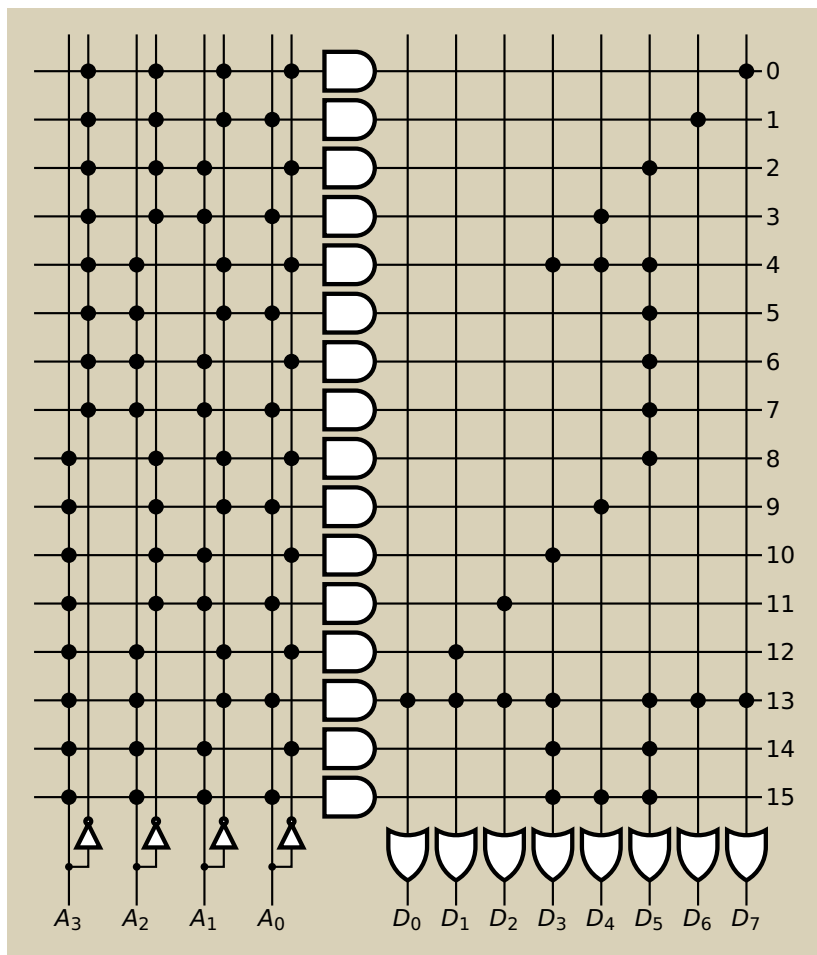

The Space Race ROM

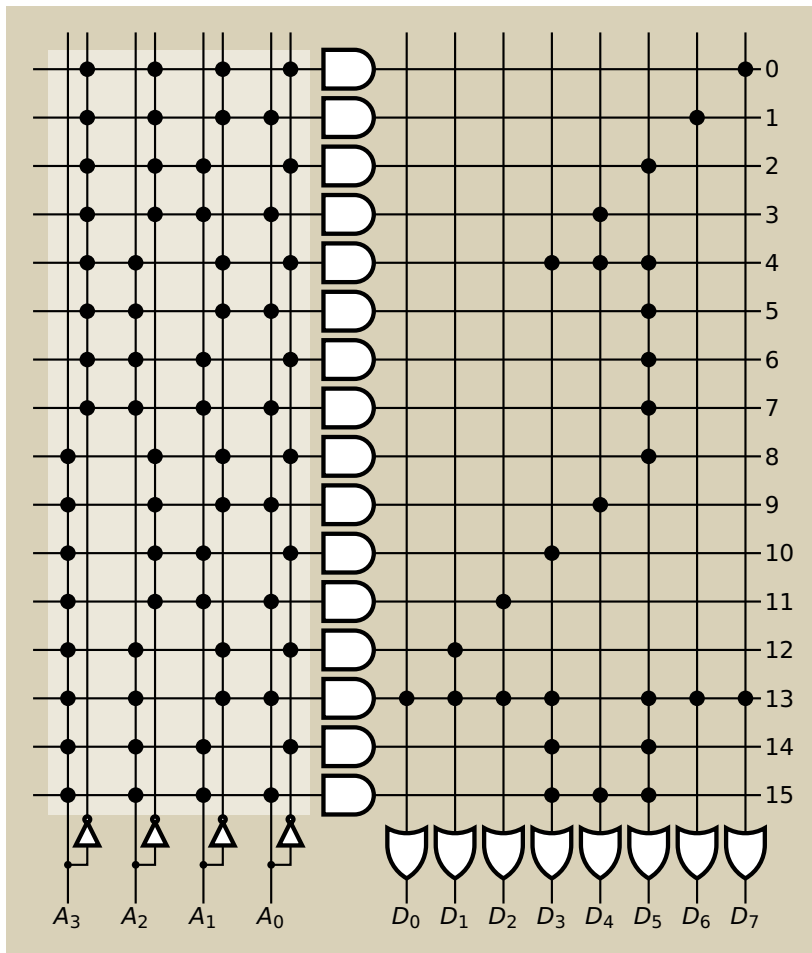

The decoder or
"AND plane"

In a RAM or ROM,
computes every
minterm

Pattern is not
programmable

The Space Race ROM

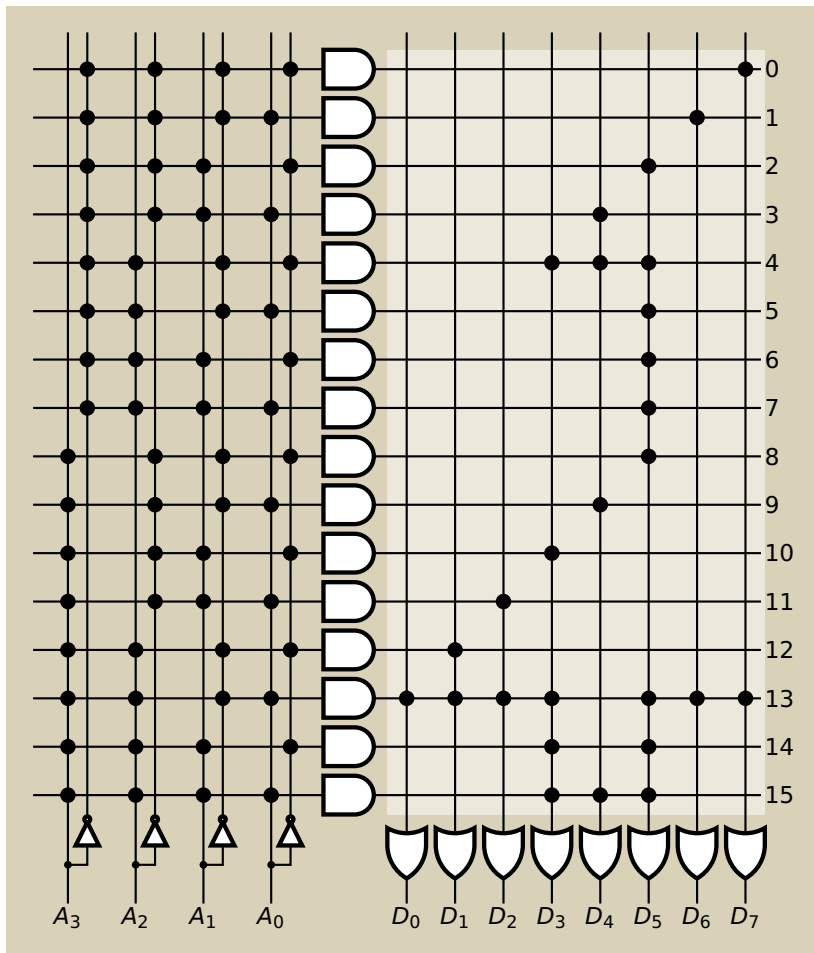

The contents or
“OR plane”

One term for every
output

Pattern is
programmable =
the contents of the
ROM

The Space Race ROM

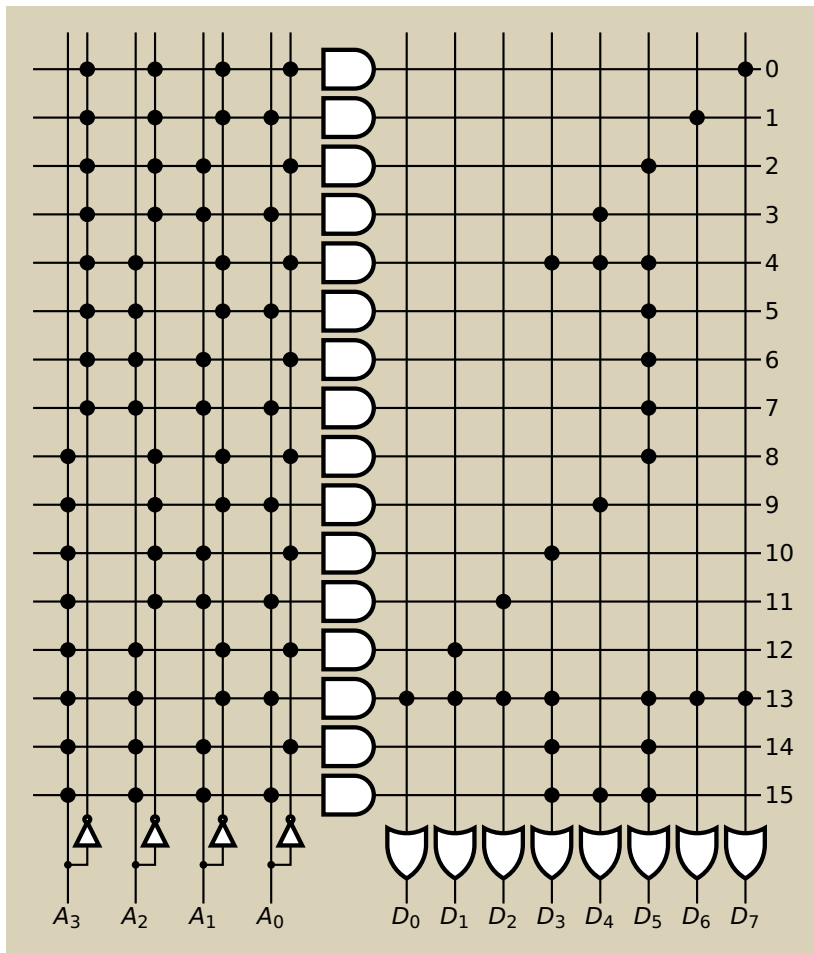

Can we do better?

Simplifying the Space Race ROM (D_0-D_7)

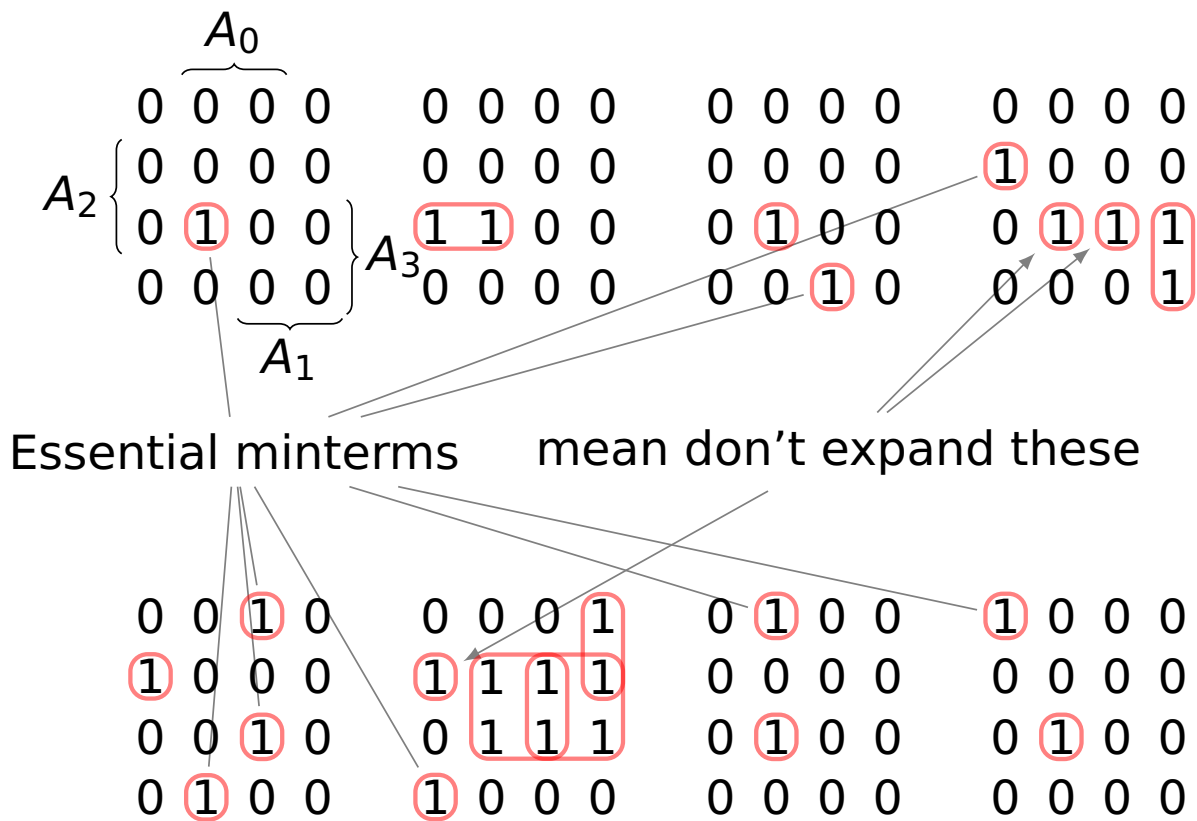

The Space Race ROM – using PAL

$$D_0 = 32\bar{1}0$$

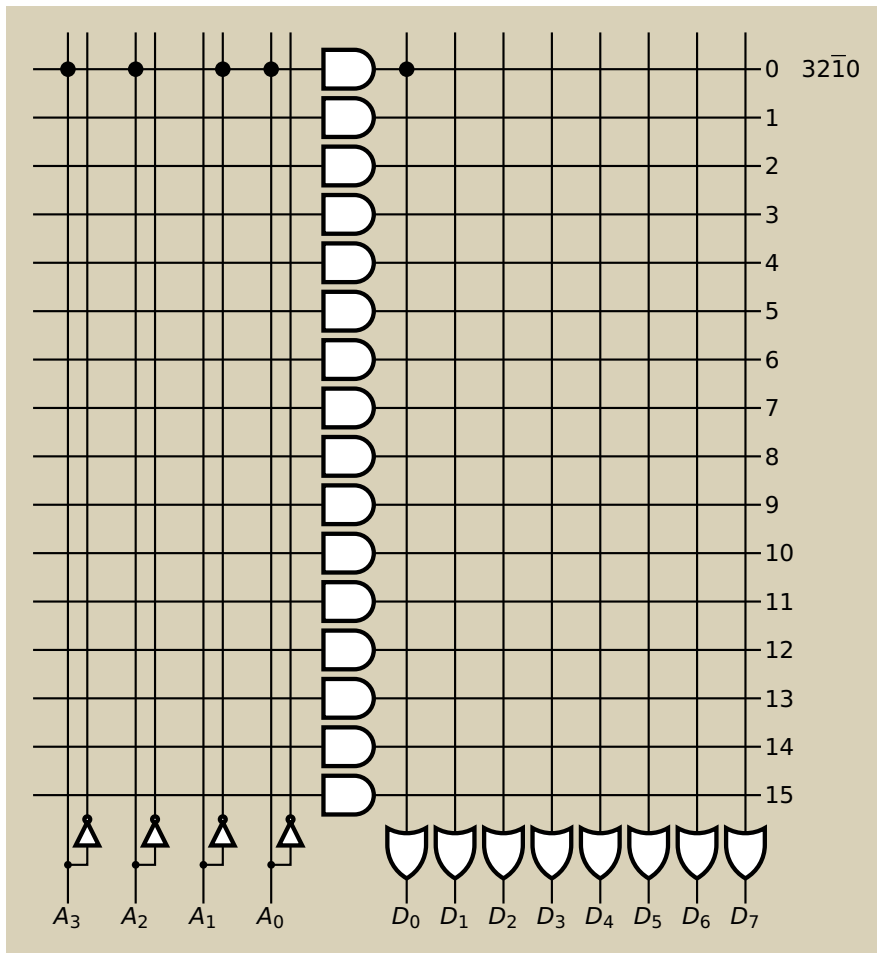

The Space Race ROM – using PAL

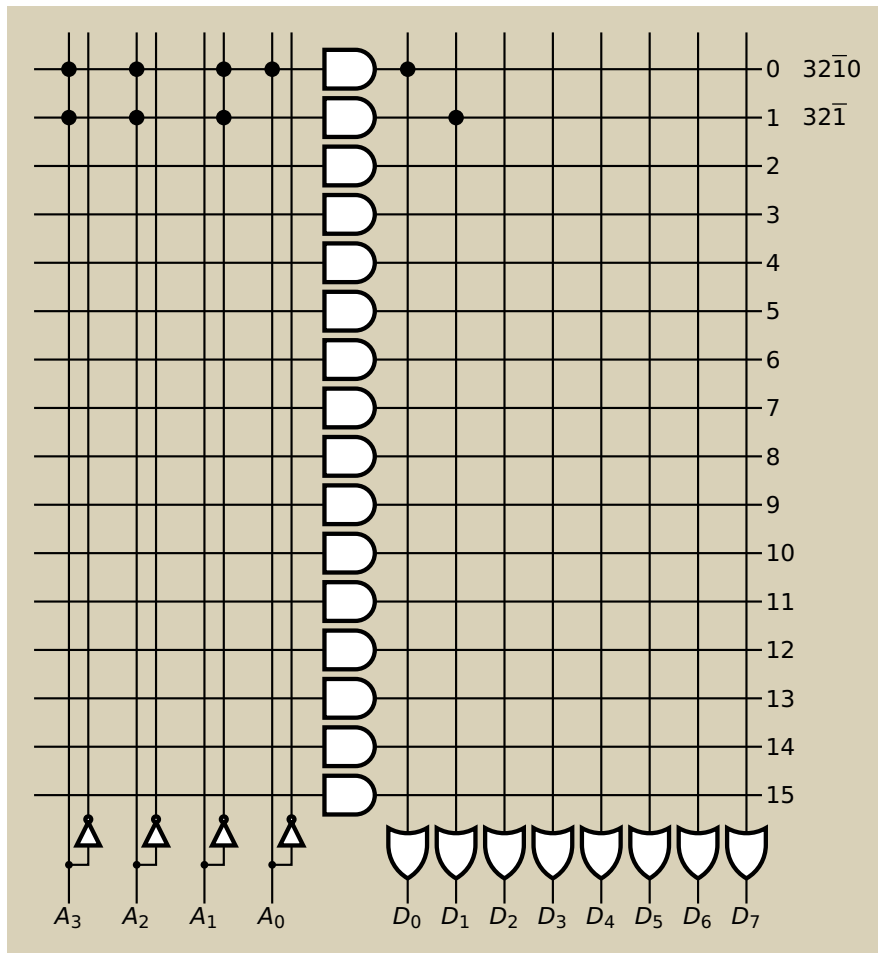

$$D_0 = 32\bar{1}0$$

$$D_1 = 32\bar{1}$$

The Space Race ROM – using PAL

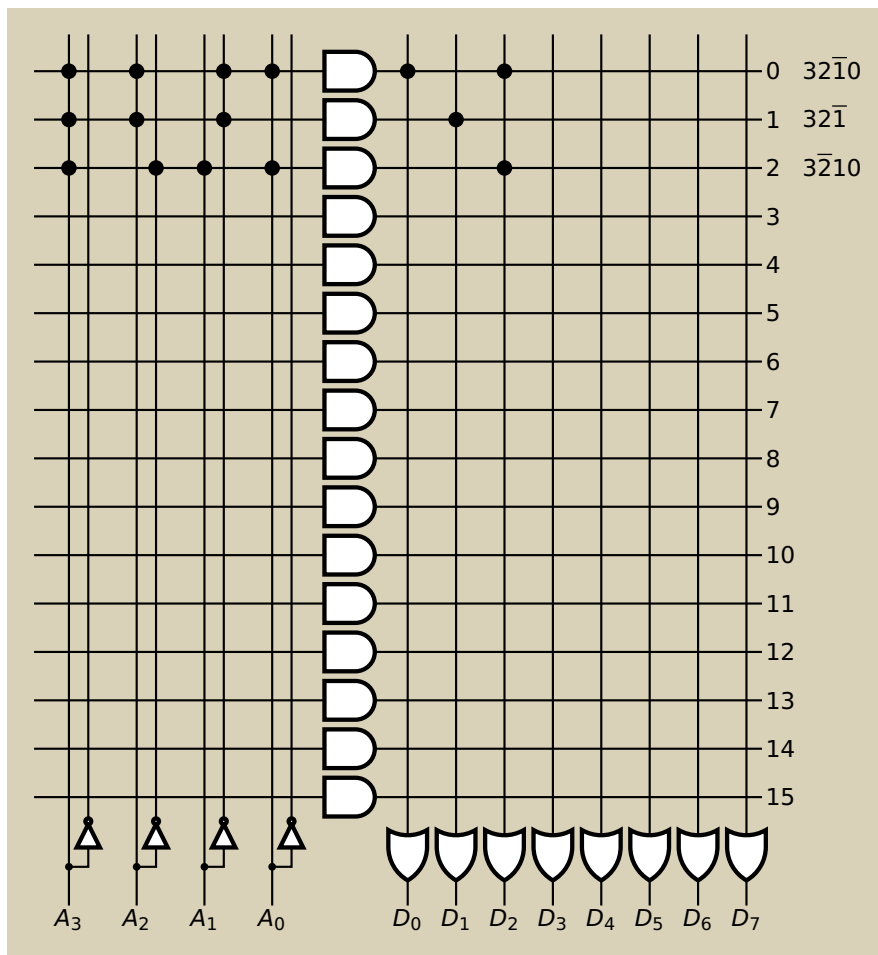

$$D_0 = 3\bar{2}\bar{1}0$$

$$D_1 = 3\bar{2}\bar{1}$$

$$D_2 = 3\bar{2}\bar{1}0 + 3\bar{2}\bar{1}0$$

The Space Race ROM – using PAL

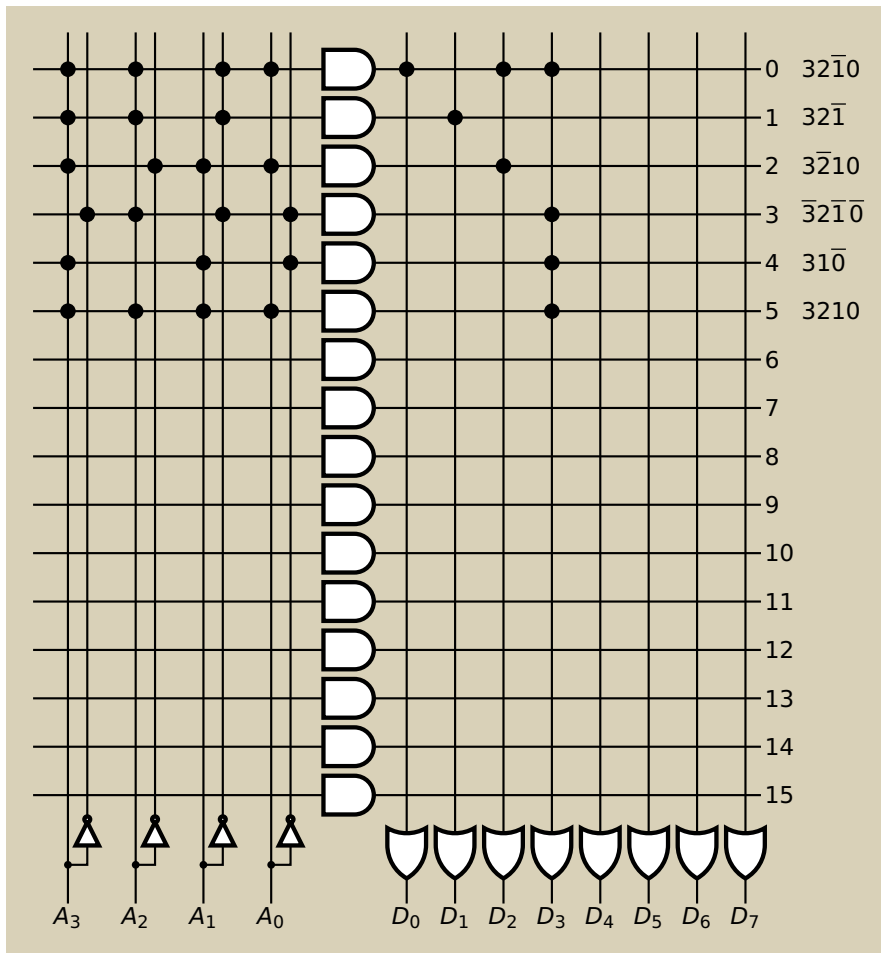

$$D_0 = 32\bar{1}0$$

$$D_1 = 32\bar{1}$$

$$D_2 = \bar{3}2\bar{1}0 + 32\bar{1}0$$

$$D_3 = \bar{3}2\bar{1}\bar{0} + 31\bar{0} + 32\bar{1}0 + 3210$$

The Space Race ROM – using PAL

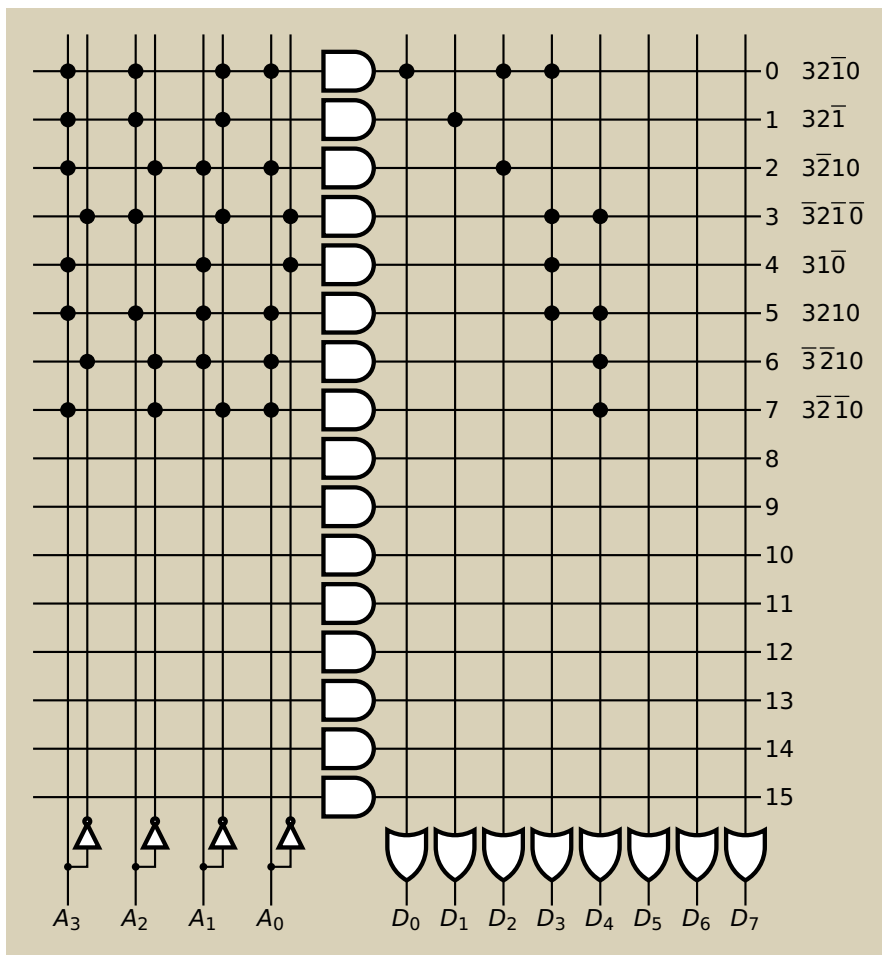

$$D_0 = 32\bar{1}0$$

$$D_1 = 32\bar{1}$$

$$D_2 = \bar{3}\bar{2}10 + 32\bar{1}0$$

$$D_3 = \bar{3}\bar{2}\bar{1}\bar{0} + 31\bar{0} + 32\bar{1}0 + 3210$$

$$D_4 = \bar{3}\bar{2}10 + \bar{3}\bar{2}\bar{1}\bar{0} + 3\bar{2}\bar{1}0 + 3210$$

The Space Race ROM – using PAL

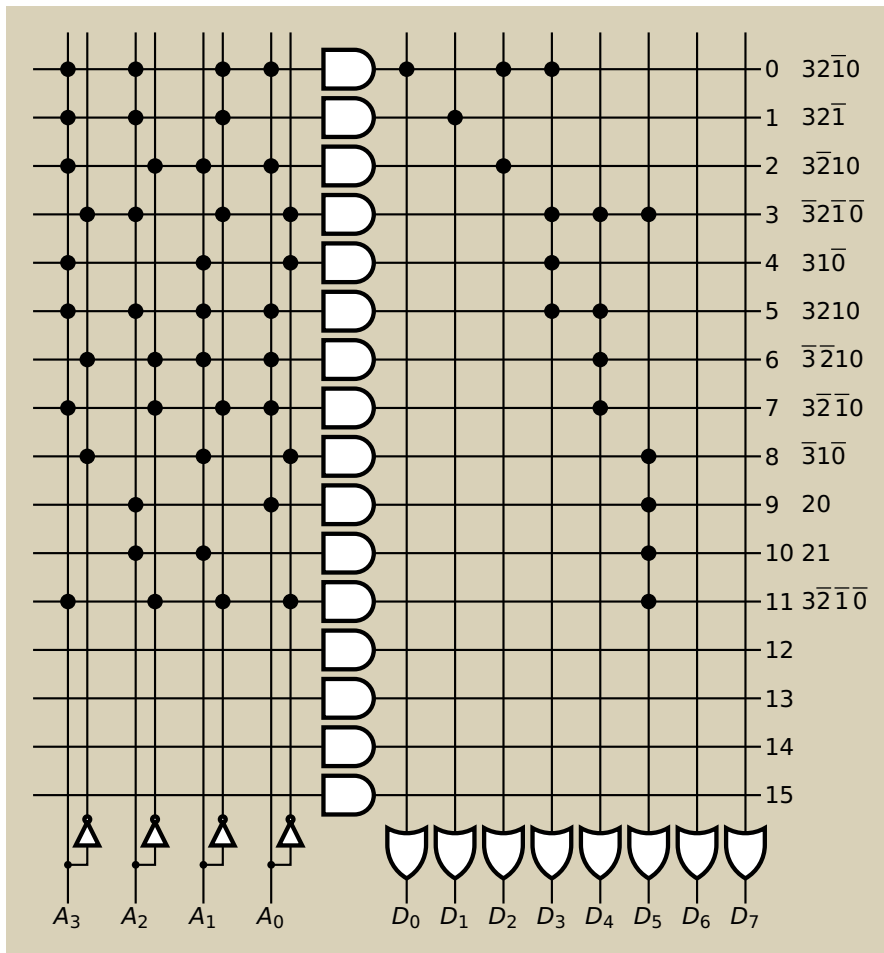

$$D_0 = 3\bar{2}\bar{1}0$$

$$D_1 = 32\bar{1}$$

$$D_2 = \bar{3}\bar{2}10 + 32\bar{1}0$$

$$D_3 = \bar{3}\bar{2}\bar{1}\bar{0} + 31\bar{0} + 32\bar{1}0 + 3210$$

$$D_4 = \bar{3}\bar{2}10 + \bar{3}\bar{2}\bar{1}\bar{0} + \bar{3}\bar{2}\bar{1}0 + 3210$$

$$D_5 = \bar{3}1\bar{0} + 20 + 21 + \bar{3}\bar{2}\bar{1}\bar{0} + \bar{3}\bar{2}\bar{1}0$$

The Space Race ROM – using PAL

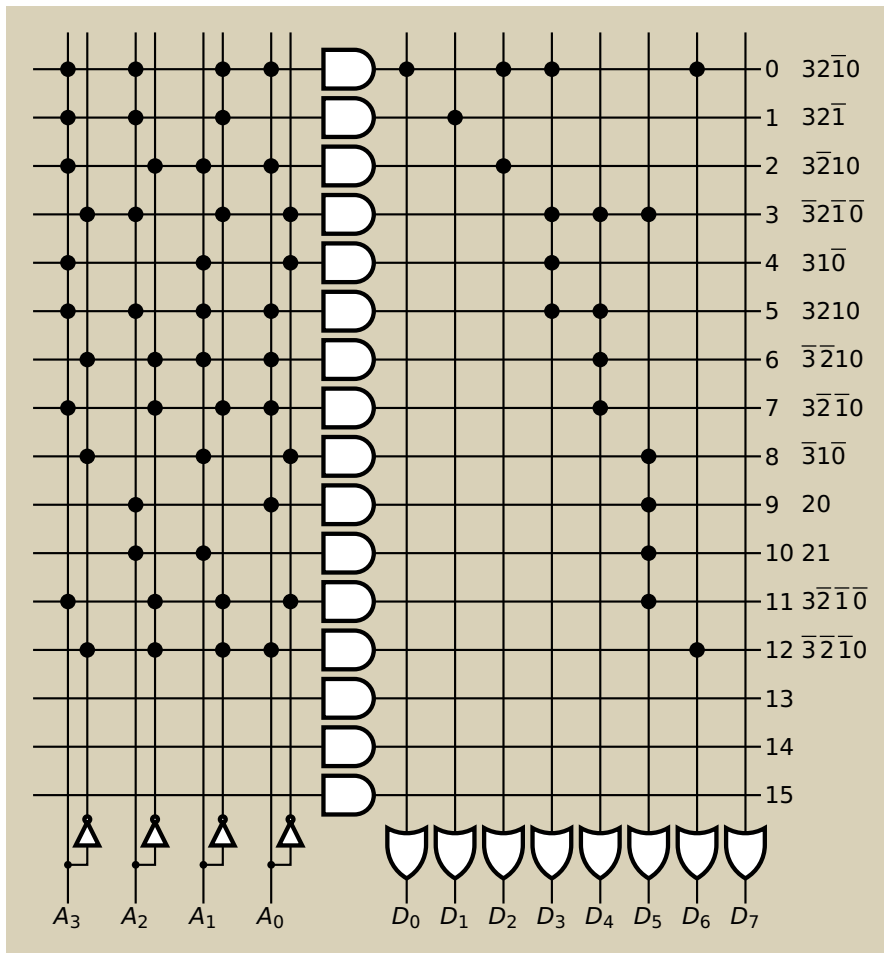

$$D_0 = 3\bar{2}\bar{1}0$$

$$D_1 = 32\bar{1}$$

$$D_2 = \bar{3}\bar{2}10 + 32\bar{1}0$$

$$D_3 = \bar{3}\bar{2}\bar{1}\bar{0} + 31\bar{0} + \bar{3}\bar{2}10 + 3210$$

$$D_4 = \bar{3}\bar{2}10 + \bar{3}\bar{2}\bar{1}\bar{0} + \bar{3}\bar{2}\bar{1}0 + 3210$$

$$D_5 = \bar{3}1\bar{0} + 20 + 21 + \bar{3}\bar{2}\bar{1}\bar{0} + \bar{3}\bar{2}10$$

$$D_6 = \bar{3}\bar{2}\bar{1}0 + 32\bar{1}0$$

The Space Race ROM – using PAL

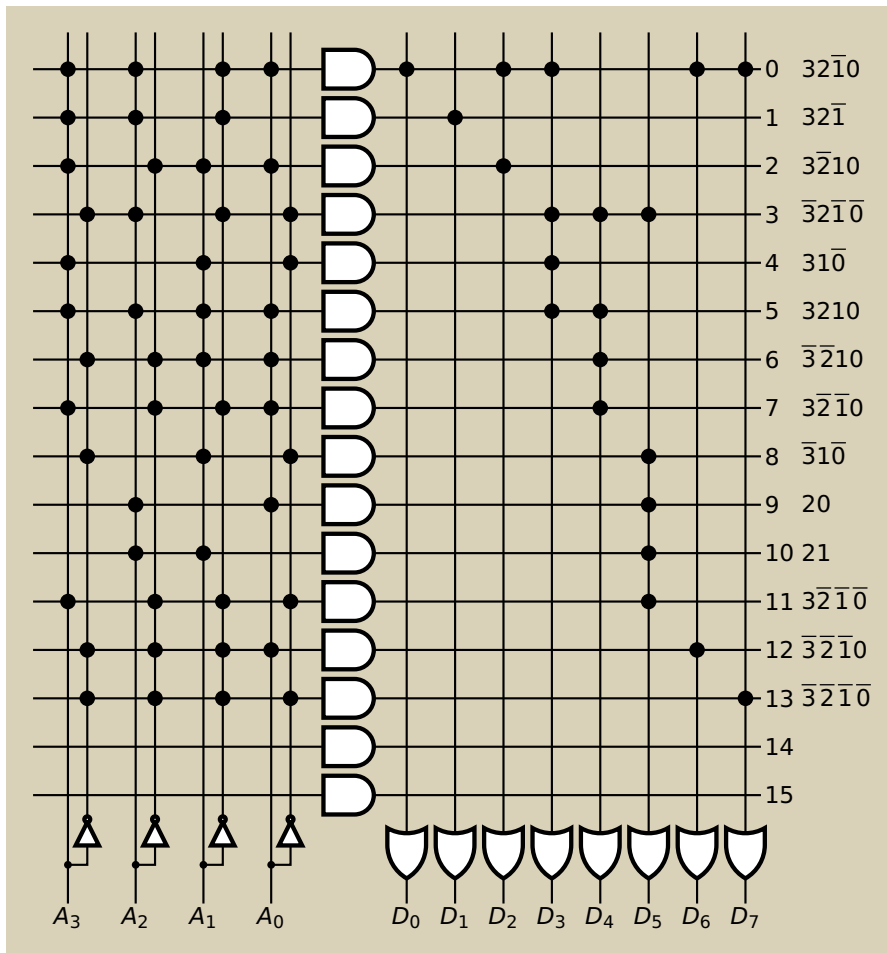

$$D_0 = 3\bar{2}\bar{1}0$$

$$D_1 = 3\bar{2}\bar{1}$$

$$D_2 = \bar{3}\bar{2}\bar{1}0 + 3\bar{2}\bar{1}0$$

$$D_3 = \bar{3}\bar{2}\bar{1}\bar{0} + 3\bar{1}\bar{0} + \bar{3}\bar{2}\bar{1}0 + 3\bar{2}\bar{1}0$$

$$D_4 = \bar{3}\bar{2}\bar{1}0 + \bar{3}\bar{2}\bar{1}\bar{0} + \bar{3}\bar{2}\bar{1}0 + 3\bar{2}\bar{1}0$$

$$D_5 = \bar{3}\bar{1}\bar{0} + 20 + 21 + \bar{3}\bar{2}\bar{1}\bar{0} + 3\bar{2}\bar{1}\bar{0}$$

$$D_6 = \bar{3}\bar{2}\bar{1}0 + 3\bar{2}\bar{1}0$$

$$D_7 = \bar{3}\bar{2}\bar{1}\bar{0} + 3\bar{2}\bar{1}0$$

Saved two ANDs

Field-Programmable Gate Arrays (FPGAs)

