





# SURVEY OF WEAPONS DEVELOPMENT AND TECHNOLOGY

WR708

SESSION I

- COURSE OVERVIEW
- WEAPON COMPLEX & DEVELOPMENT PROCESS

~~SECRET~~

~~SECRET~~

UNCLASSIFIED

UNCLASSIFIED

# SURVEY OF WEAPONS DEVELOPMENT AND TECHNOLOGY WR708

<u>Day</u>	<u>Time</u>	<u>Session</u>	<u>Title</u>	<u>Instructor</u>		
Monday	8:00 - 12:00	1	Course Overview - Introduction	Hogan		
		2	Physics - Explosion Theory	Hogan		
	1:00 - 4:00	2	Physics - Explosion Theory (cont)	Hogan		
		3	Nuclear Effects	Hogan		
Tuesday	8:00 - 12:00	4	High Explosives - Detonators	Hogan		
		5	Fission	Hogan		
	1:00 - 4:00	5	Fission (cont)	Hogan		
		6	Thermonuclear	Hogan		
		Wednesday	8:00 - 12:00	6	Thermonuclear (cont)	Hogan
				7	Safety	Layne
1:00 - 3:00	7	Safety (cont)	Layne			
	8	Use Control - Access Control	Layne			
	9	Weapons Systems	Rogulich			
Thursday	8:00 - 9:00	10	Dismantlement	Hogan		
		11	Arming, Firing and Initiation	Curtis		
		12	Nuclear Testing	Hogan		
1:00 - 4:00	13	Transfer Systems	Robinson			
	14	Fuzing	Hartwig			
	15	Arms Control	Layne			
Friday	8:00 - 9:00	15	Arms Controls (cont)	Layne		
	9:00 - 10:00	16	Non-Proliferation/Counter Proliferation	Taylor		
	10:00 - 11:00	17	Stockpile Matters	Layne		
	11:00 - 11:15		Summary	Hogan		
	12:00 - 3:30	18	Nuclear Weapons Musuem Tour	Hogan		

**SECRET**

UNCLASSIFIED

UNCLASSIFIED

**SECRET**

# WR708 - Course Objectives

## What We hope you learn

---

- The nuclear physics principles
- Nuclear weapons engineering implementation
- Depth and breath of the nuclear weapons program
- Principles of nuclear surety
- Surety as implemented in the enduring stockpile weapons
- Operation of the enduring stockpile weapons
- Similarities/differences of the weapons
- The evolution of nuclear stockpile over the last 50 years
- The principle drivers of the nuclear stockpile over the last 50 years
- Nuclear weapons subsystem components and their evolution

~~SECRET~~

UNCLASSIFIED

~~SECRET~~

UNCLASSIFIED

## Course Themes

---

- Stockpile surety
- Stewardship
- Historical teaching approach
- Extensive use of hardware
- Survey of almost all aspects of nuclear weapons

~~SECRET~~

UNCLASSIFIED

~~SECRET~~

UNCLASSIFIED

~~SECRET~~

UNCLASSIFIED

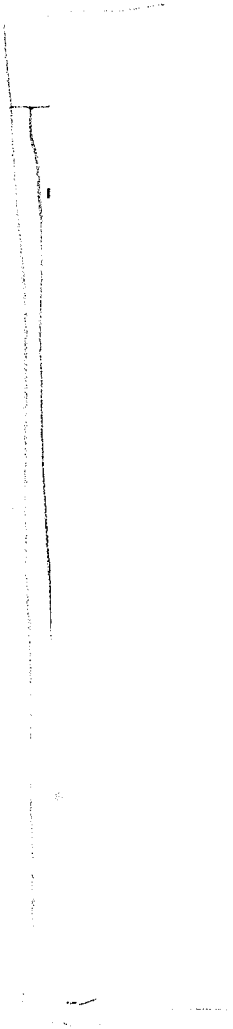

DoE  
b(3)

b(3)

UNCLASSIFIED

~~SECRET~~

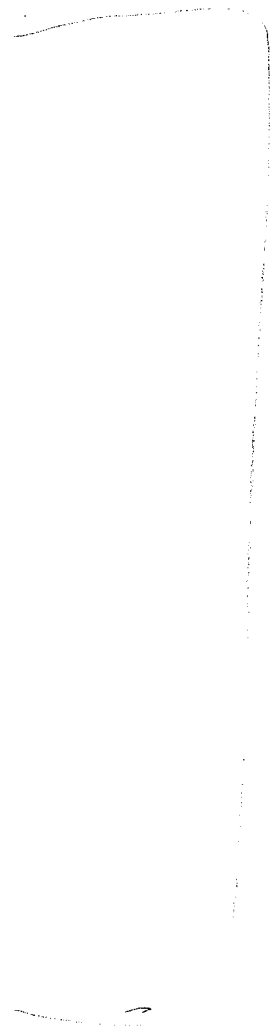

## OVERVIEW (Continued)

---

- There have been weapon system, aircraft and missile trades which have over the last 50 years driven the nuclear weapons community to design smaller, lighter, yet higher-yield weapons.
- A systems engineering approach is required when viewing nuclear weapons.
- Arms control is a major driver for weapons reduction.
- History and early weapon development is extremely important to the understanding of third world proliferation.

~~SECRET~~

UNCLASSIFIED

~~SECRET~~

UNCLASSIFIED



# Nuclear Weapons Development Drivers

---

- Nuclear surety
- Service Requirements/weapon system interfaces
  - less manpower intensive
  - less weight and volume
- National security strategy/policy
  - United States
  - CINC's
  - NATO
- Arms control
  - limit technology
  - limit growth
  - eliminate categories
  - reduce numbers

~~SECRET~~

UNCLASSIFIED

~~SECRET~~

UNCLASSIFIED

## National Security Strategy: Deterrence

---

<u>Decade</u>	<u>Implementation</u>
1950	Massive Retaliation
1960	Flexible Response
1970	Flexible Response
1980	Flexible Response
1990	Last Resort

~~SECRET~~

UNCLASSIFIED

UNCLASSIFIED

~~SECRET~~



# SIGNIFICANT HISTORICAL EVENTS RELATIVE TO NUCLEAR WEAPONS

UNCLASSIFIED

~~SECRET~~

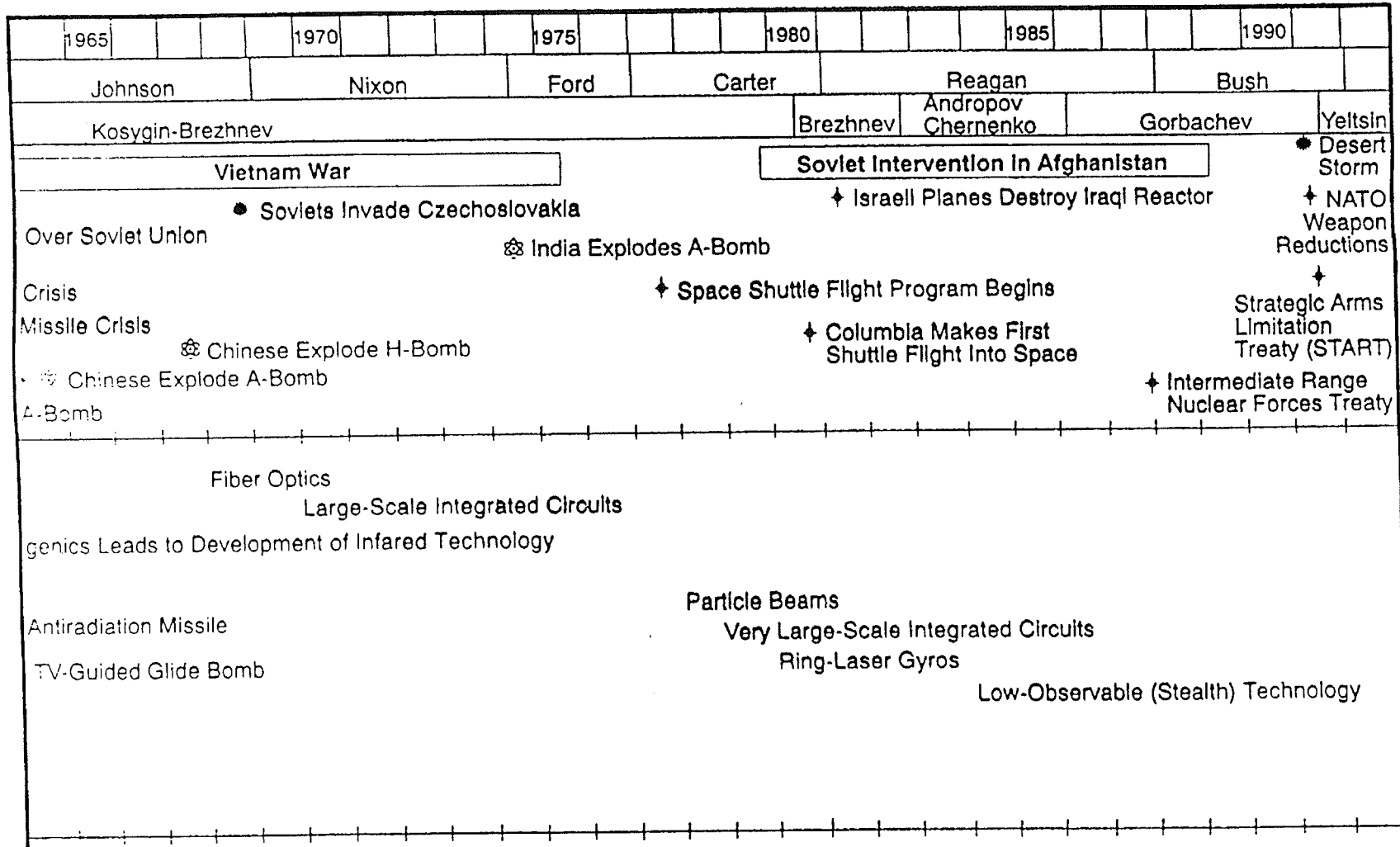

UNCLASSIFIED

~~SECRET~~

## Strategy, Arms Control, and Weapon Systems Technology Drive Stockpile Requirements

Strategy	Threat	Tech.	Size/Wt.	Yield	Arms Control	Number
1950 Massive retaliation	Global	A/C & missiles inaccurate	Large	Very high	Very limited talks	Growing
1960 Flexible response	Global Theater	A/C & missiles improve	Decrease	Decrease	Limited talks	Growing
1970 Flexible response	Global Theater	A/C & missiles improve accuracy	Decrease even more	Tactical needed lower yields	SALT ABM limitations	Decline
1980 Flexible response	Global Theater	A/C & missiles very accurate	Large decrease	Continued decrease	Mutual elimination & reduce	Decline more
1990 Last resort	Theater Global	A/C & missiles very accurate	Remain small	Remain same	Large cuts mutual elimination/unilateral	Large reduction

~~SECRET~~

UNCLASSIFIED

~~SECRET~~

UNCLASSIFIED

~~SECRET~~

UNCLASSIFIED

# SELECTED HARDWARE ORIENTATION

UNCLASSIFIED

~~SECRET~~

# Fission Primaries

IMPLOSION

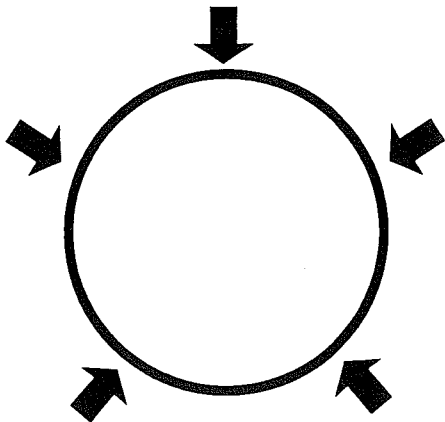

Critical Mass Achieved with Compression from HE

GUN TYPE

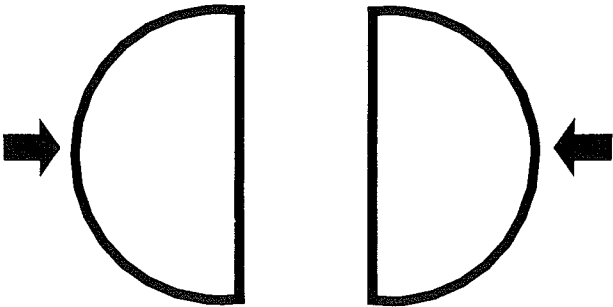

Critical Mass Achieved with "Lots of Special Nuclear Material"

~~SECRET~~

UNCLASSIFIED

~~SECRET~~  
UNCLASSIFIED

# Fission Primary

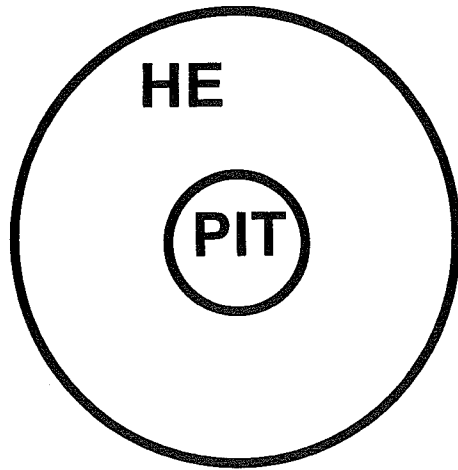

Detonators Required to Fire the HE

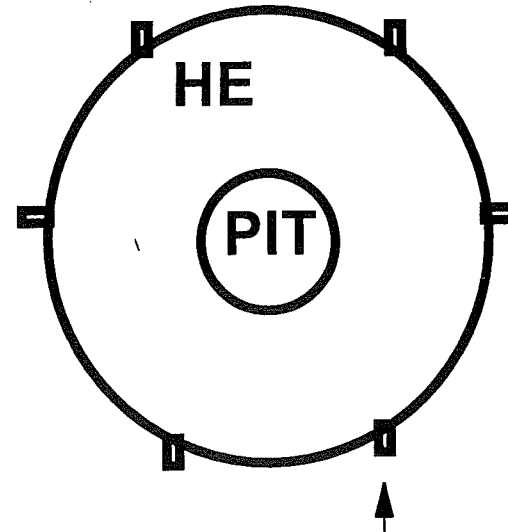

Original Detonators Large

~~SECRET~~

UNCLASSIFIED

UNCLASSIFIED

~~SECRET~~



# Basic Electronics Needed to Fire the Detonations

~~SECRET~~

UNCLASSIFIED

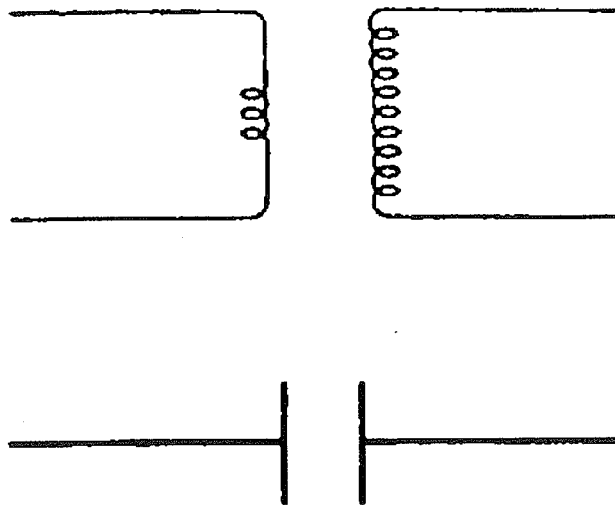

**FIRE SET**  
Evolved from Large to Compact

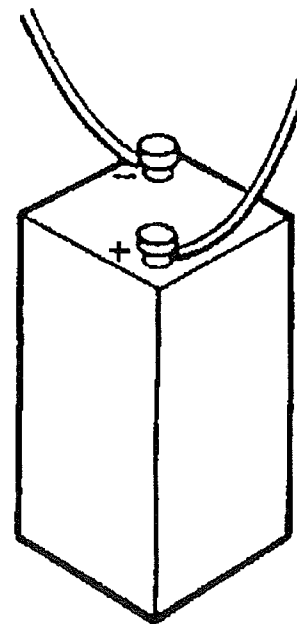

**POWER SOURCES**  
Originally Lead Acid (car battery style)  
Evolved to Thermal Batteries

UNCLASSIFIED

~~SECRET~~

# Additional Elements Required for Detonation

~~SECRET~~

UNCLASSIFIED

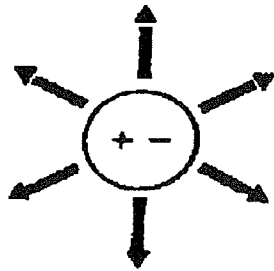

Neutron Source

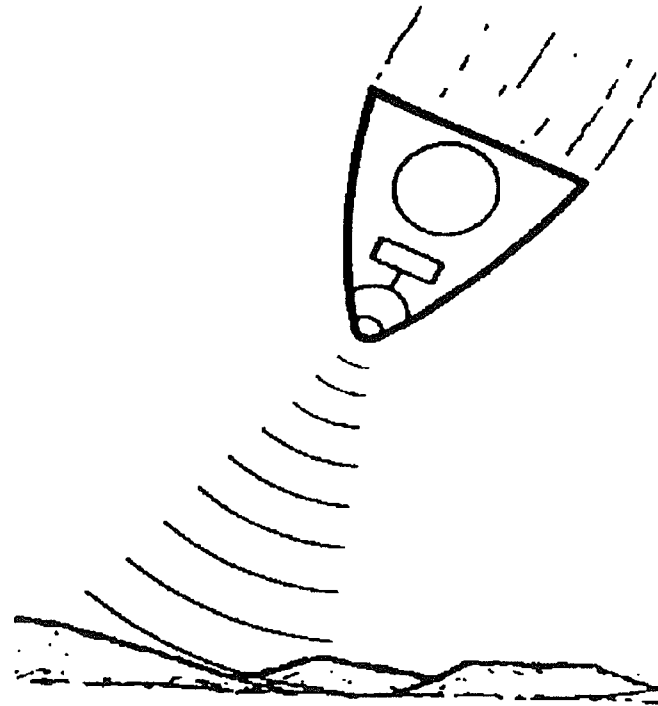

Fuzes

- Height of Burst
- Impact

UNCLASSIFIED

~~SECRET~~

# Basic Elements of a Nuclear Weapon

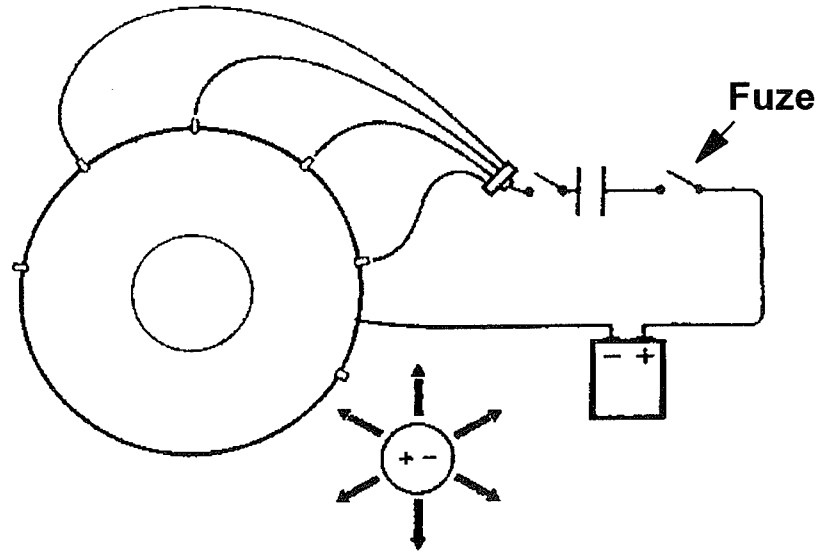

~~SECRET~~

UNCLASSIFIED

UNCLASSIFIED

~~SECRET~~

## GAS BOOSTING

- INITIAL FISSION RAISES BOOST GAS TO FUSION TEMPERATURES
- D.T REACTIONS RELEASE A FLOOD OF HIGH ENERGY NEUTRONS FOR FISSIONING OF O<sub>y</sub> AND/OR Pu

~~SECRET~~

UNCLASSIFIED

UNCLASSIFIED

~~SECRET~~

B-3

~~SECRET~~

UNCLASSIFIED

DOIE

1

UNCLASSIFIED

~~SECRET~~

# DIVISION OF RESPONSIBILITIES

UNCLASSIFIED

~~SECRET~~

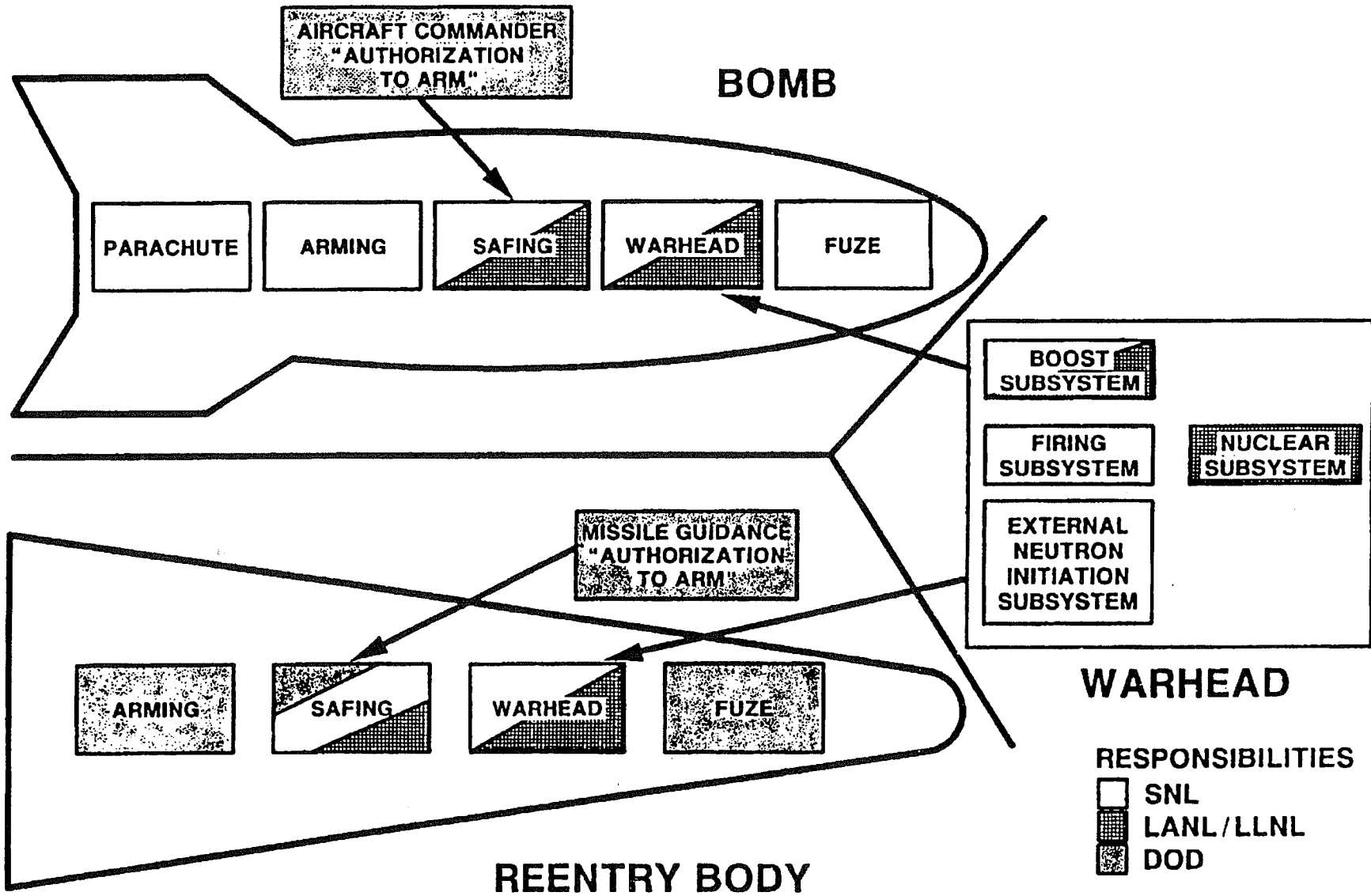

~~SECRET~~  
UNCLASSIFIED

# TERMINOLOGY

NUCLEAR PACKAGE  
PHYSICS PACKAGE

➤ PRIMARY/SECONDARY  
(Includes High Explosive)

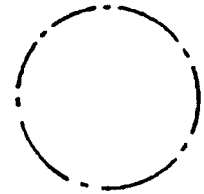

NUCLEAR WARHEAD

➤ NUCLEAR PACKAGE &  
WEAPON ELECTRICAL  
SYSTEM & PLUMBING

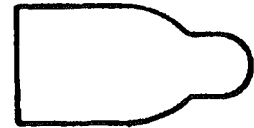

NUCLEAR WEAPON

➤ NUCLEAR WARHEAD &  
ARMING & FUZING &  
AERODYNAMIC CASE,  
ALSO REENTRY VEHICLE



NUCLEAR WEAPON SYSTEM

➤ NUCLEAR WEAPON & DoD  
DELIVERY SYSTEM

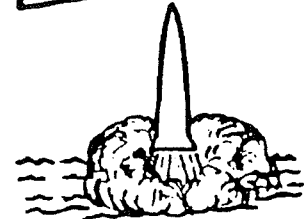

- THE TERM NUCLEAR DEVICE USUALLY IMPLIES A TEST WARHEAD BUT IS SOMETIMES USED IN A PLACE OF EITHER NUCLEAR PACKAGE OR WARHEAD

- THE ARMY USED THE TERM NUCLEAR WARHEAD SECTION TO INCLUDE WARHEAD + AK + BALLISTIC BASE

~~SECRET~~  
UNCLASSIFIED

~~SECRET~~  
UNCLASSIFIED

# WEAPON PROGRAM OBLIGATIONS

## STOCKPILE MANAGEMENT:

MAINTENANCE OF THE NATIONAL STOCKPILE OF NUCLEAR WEAPONS IN A SAFE, SECURE, RELIABLE, READY CONDITION

## WEAPONIZATION:

DEVELOP AND PRODUCE NUCLEAR WEAPONS FOR STOCKPILE AS JOINTLY AGREED TO BY DOD & DOE AND AS AUTHORIZED BY THE PRESIDENT

## WEAPON TECHNOLOGY:

PURSUE TECHNOLOGY IN THE SCIENCE & ENGINEERING OF NUCLEAR WEAPONS SO THAT OUR UNDERSTANDING & ABILITY TO DEVELOP IS SECOND TO NONE

~~SECRET~~

UNCLASSIFIED

~~SECRET~~

UNCLASSIFIED



# **As the nuclear weapons systems integrator for the DOE, Sandia has responsibility for:**

---

- Fire set development--neutron generator, batteries, capacitors, etc.
- Electrical & mechanical interface compatibility
- Electrical detonation safety
- Use control & use control equipment
- Handling and ancillary equipment
- Stockpile surveillance (reliability)--testing & evaluation
- Military training & manuals
- Field support
- Weapon systems (including DoD hardware) independent evaluations
- DOE & DoD security facility upgrade
- Safe secure trailers (total life cycle) & DOE courier training
- Neutron generator production

~~SECRET~~

UNCLASSIFIED

~~SECRET~~

UNCLASSIFIED

# SANDIA-DOE / DOD INTERFACES WEAPON PROGRAM

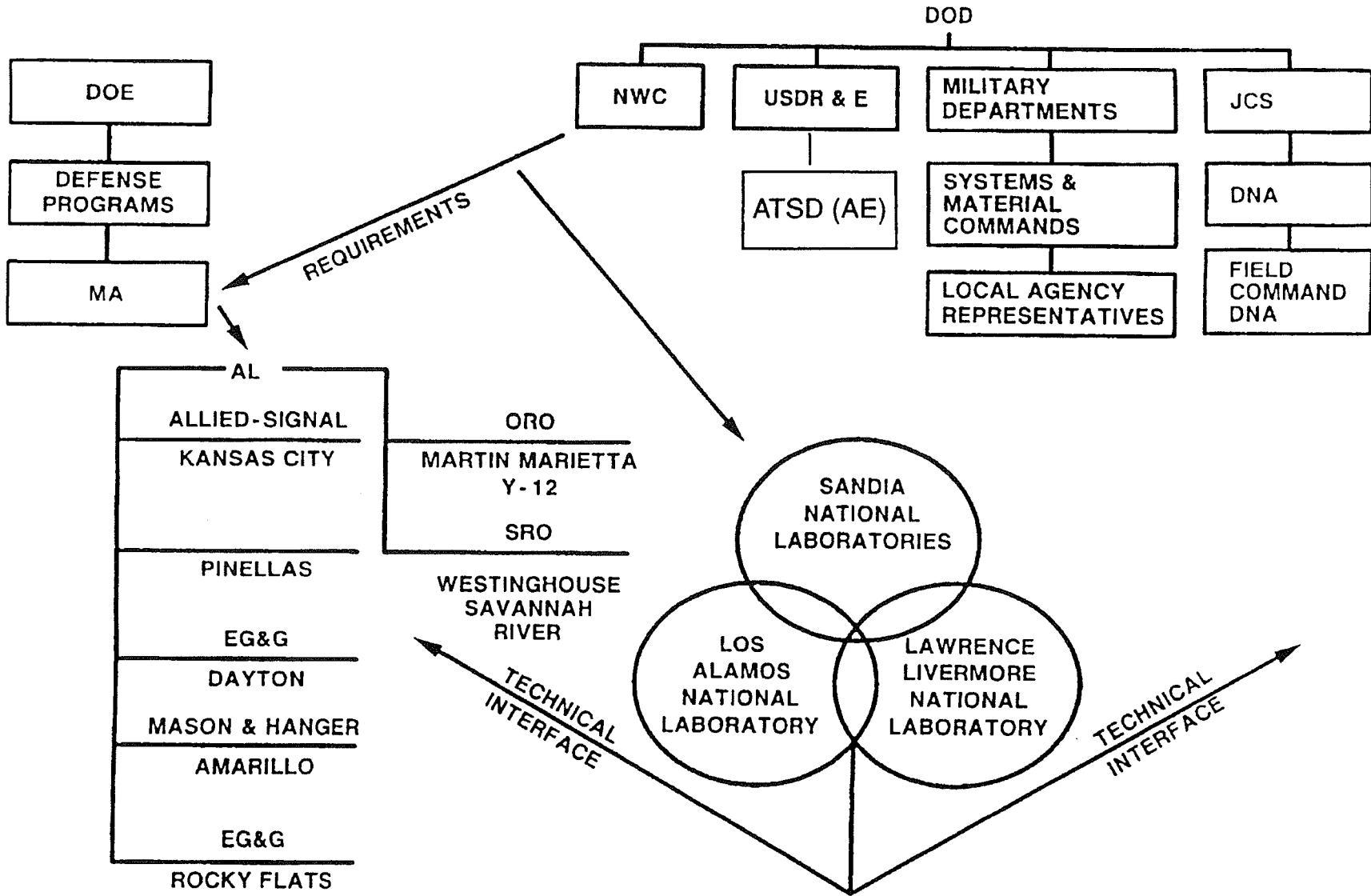

~~SECRET~~

UNCLASSIFIED

~~SECRET~~

UNCLASSIFIED

# Rocky Flats Golden, Colorado -Historical Context-

**Contractor:** EG&G

**Principal Missions:** Fabrication of beryllium,  
plutonium on uranium alloy;  
Plutonium recovery and  
research;  
Fabrication of pressure  
vessels

~~SECRET~~

UNCLASSIFIED

~~SECRET~~

UNCLASSIFIED

# Kansas City Plant Kansas City, Missouri

**Contractor:** Allied-Signal

**Principal Missions:** Fabrication and assembly of  
electrical, electronic,  
electro-mechanical, precision  
mechanical, rubber and plastic  
components;  
Heavy machining

~~SECRET~~

UNCLASSIFIED

UNCLASSIFIED

~~SECRET~~

# Y-12 Plant

## Oak Ridge, Tennessee

**Contractor:** Martin Marietta

**Principal Missions:** Fabrication of test and stockpile secondary assemblies;  
Fabrication and research in uranium;  
Machining

~~SECRET~~

UNCLASSIFIED

~~SECRET~~

UNCLASSIFIED

~~SECRET~~

UNCLASSIFIED

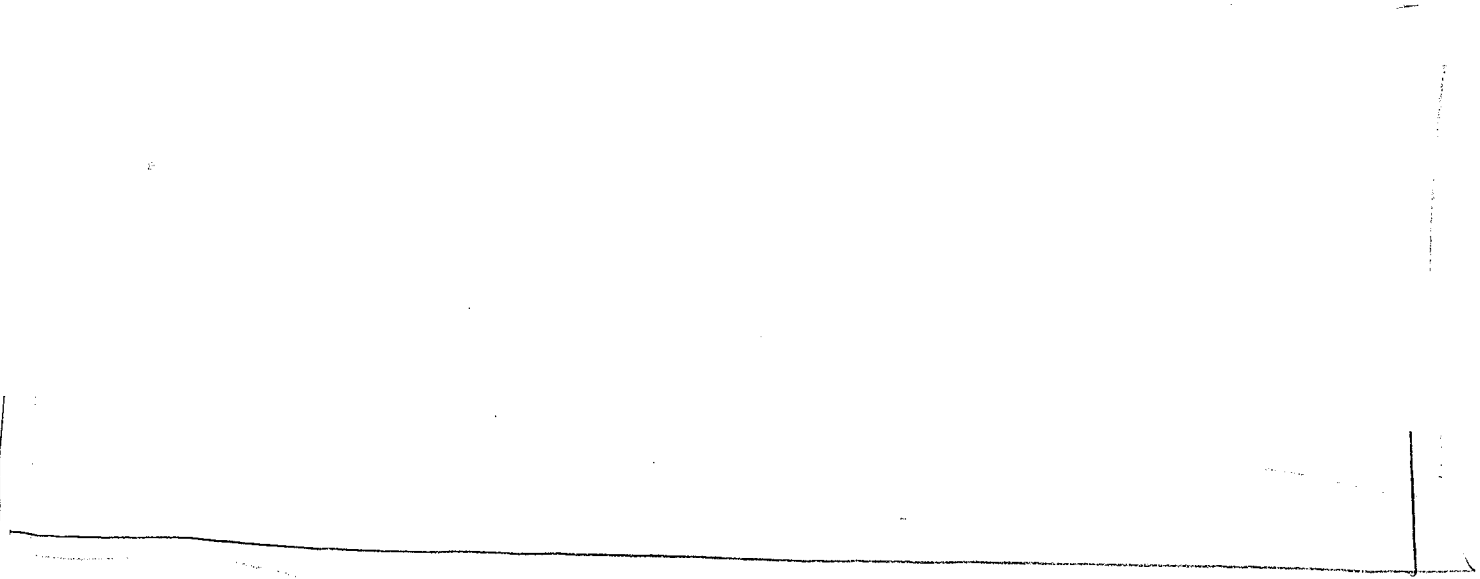

6/1

~~SECRET~~

UNCLASSIFIED

# Pinellas Plant

## St. Petersburg, Florida

**Contractor:** Martin Marietta speciality components, inc.

**Principal Missions:** Neutron generators, thermal batteries, Radioisotopic Thermoelectric Generator (RTGs), lightning arrestor connectors, capacitors, neutron detectors

~~SECRET~~

UNCLASSIFIED

~~SECRET~~

UNCLASSIFIED

# Savannah River Plant Aiken, South Carolina

**Contractor:** Westinghouse

**Principal Missions:** Production of tritium and  
plutonium;  
Fill reservoirs with tritium

~~SECRET~~

UNCLASSIFIED

~~SECRET~~

UNCLASSIFIED



# **Pantex Plant Amarillo, Texas**

**Contractor: Mason and Hanger**

**Principal Missions: Fabricate high explosive system;  
Final assembly, disassembly and retirement of weapons**

~~SECRET~~

UNCLASSIFIED

~~SECRET~~

UNCLASSIFIED

## Historical Pressure on Nuclear Designs

		PEACETIME EMPHASIS	WARTIME EMPHASIS
IMPROVE		SAFETY  SECURITY  CONTROL	SURVIVABILITY DELIVERABILITY EFFECTIVENESS FLEXIBILITY BATTLE MANAGEMENT
REDUCE		MAINTENANCE  MOVEMENT  TRAINING	REACTION TIME  OPERATIONAL CONSTRAINTS COLLATERAL DAMAGE

~~SECRET~~

UNCLASSIFIED

UNCLASSIFIED

~~SECRET~~

# PHASE 1 CONCEPT FORMULATION

(01)

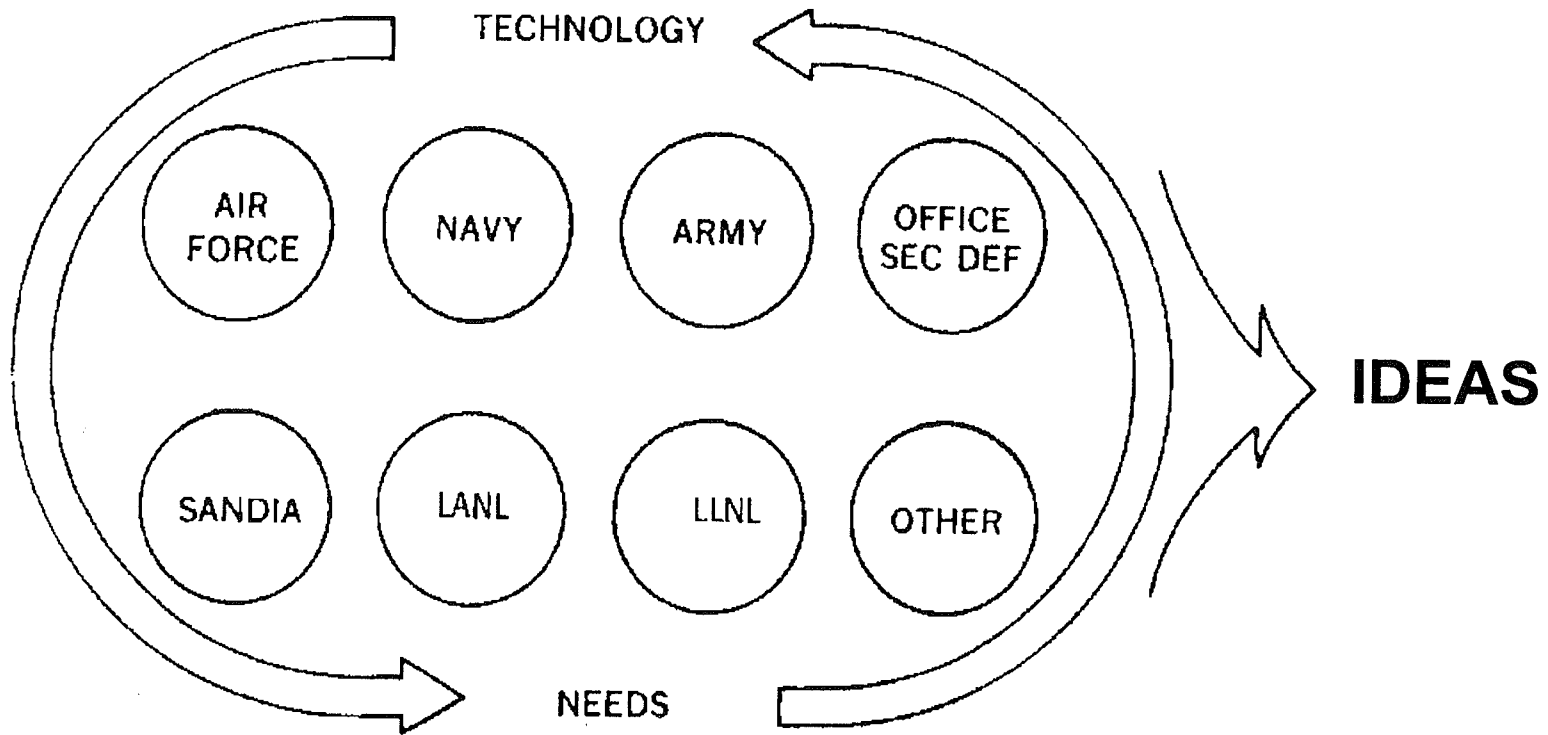

~~SECRET~~

UNCLASSIFIED

~~SECRET~~

UNCLASSIFIED

## Phase 1 - Weapon Conception

### DOE

Continuing studies by DOE agencies. Studies may be informal and independent from DoD or may be conducted jointly with DoD. May result in the focusing of sufficient DoD interest in a modification of a present weapon or in the development of a new type weapon to warrant formal study.

### DoD

Continuing studies by DoD agencies. May be independent of the DOE or may be conducted jointly with DOE. Sufficient attention may become focused on an item to warrant a formal program study. DoD requests DOE to make a program study on a new idea for a weapon or component or may initiate its own study.

~~SECRET~~

UNCLASSIFIED

UNCLASSIFIED

~~SECRET~~

# PHASE 2 FEASIBILITY

(02)

UNCLASSIFIED

~~SECRET~~

IDEAS

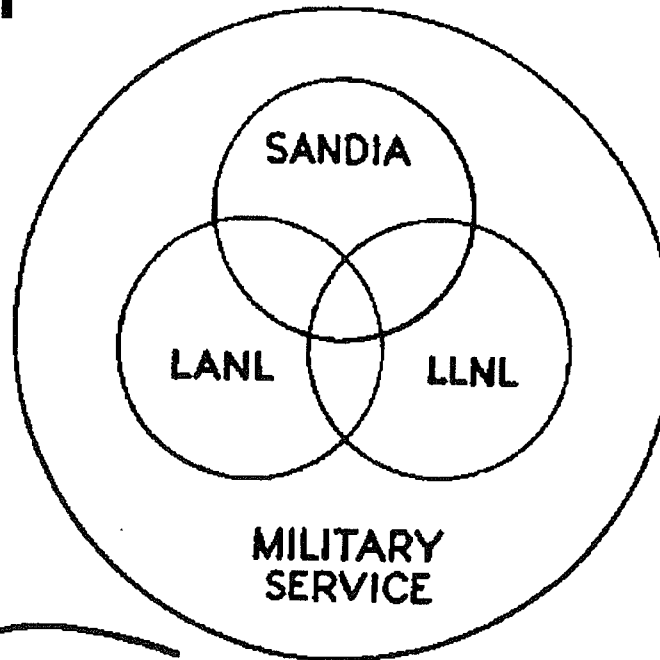

DESIGN ALTERNATIVES  
MAJOR IMPACT  
REPORT



~~SECRET~~

UNCLASSIFIED

# Phase 2A VALIDATION (Φ2A)

- SELECT BASELINE DESIGN & LAB
- SCHEDULE
- WEAPON DESIGN & COST REPORT (WDCR)

**DESIGN TEAM SELECTION**

**DESIGN ALTERNATIVES**

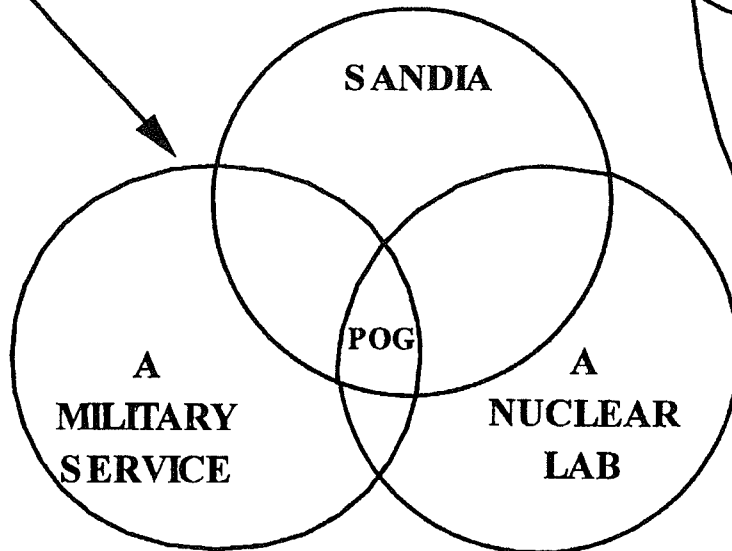

~~SECRET~~

UNCLASSIFIED

UNCLASSIFIED

~~SECRET~~

Phase 2A - Design Definition and Cost Studies

A DOE design team will normally be selected and a Project Officer Group will be formed. The POG will conduct trade-off studies to identify baseline design(s) which best balances resources and requirements. Review and revise draft MCs and STs. Establish tentative development and production schedule and division of responsibilities. A Weapon Design and Cost Report will be prepared.

~~SECRET~~

UNCLASSIFIED

~~SECRET~~

UNCLASSIFIED

# Phase 3 ENGINEERING DEVELOPMENT (O3)

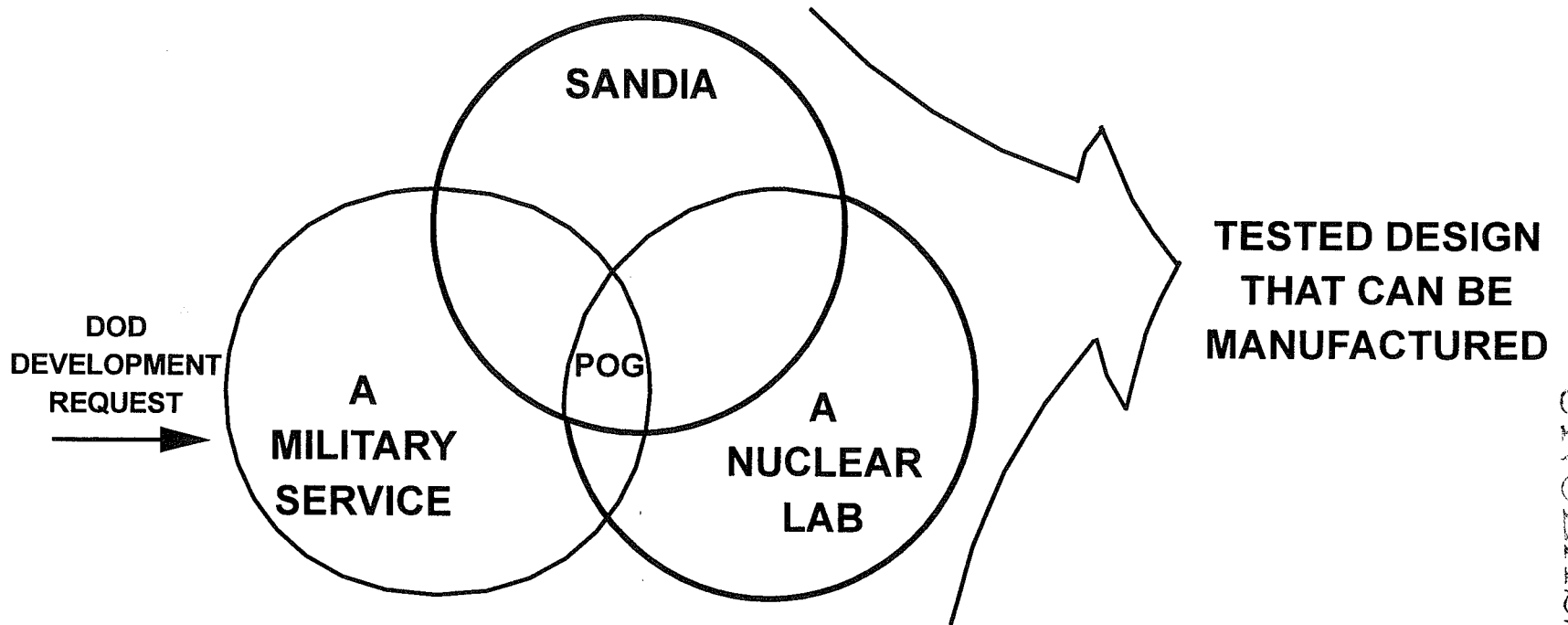

~~SECRET~~  
UNCLASSIFIED

~~SECRET~~  
UNCLASSIFIED



~~SECRET~~

UNCLASSIFIED

### **Phase 3 - Development Engineering**

#### **DOE**

Launches a development program based on required military characteristics. Produces prototypes for DOE and DoD evaluation.

Provides development specifications to DoD as they become available.

Determines the developmental design release date and submits a final report on the development design to the DoD.

#### **DoD**

Maintains liaison with DOE field agencies and conducts independent evaluation of prototypes as considered necessary.

Studies the development specifications of the weapon design and gives appropriate guidance to the DOE.

~~SECRET~~

UNCLASSIFIED

# Phase 4-6 PRODUCTION (Φ4-Φ6)

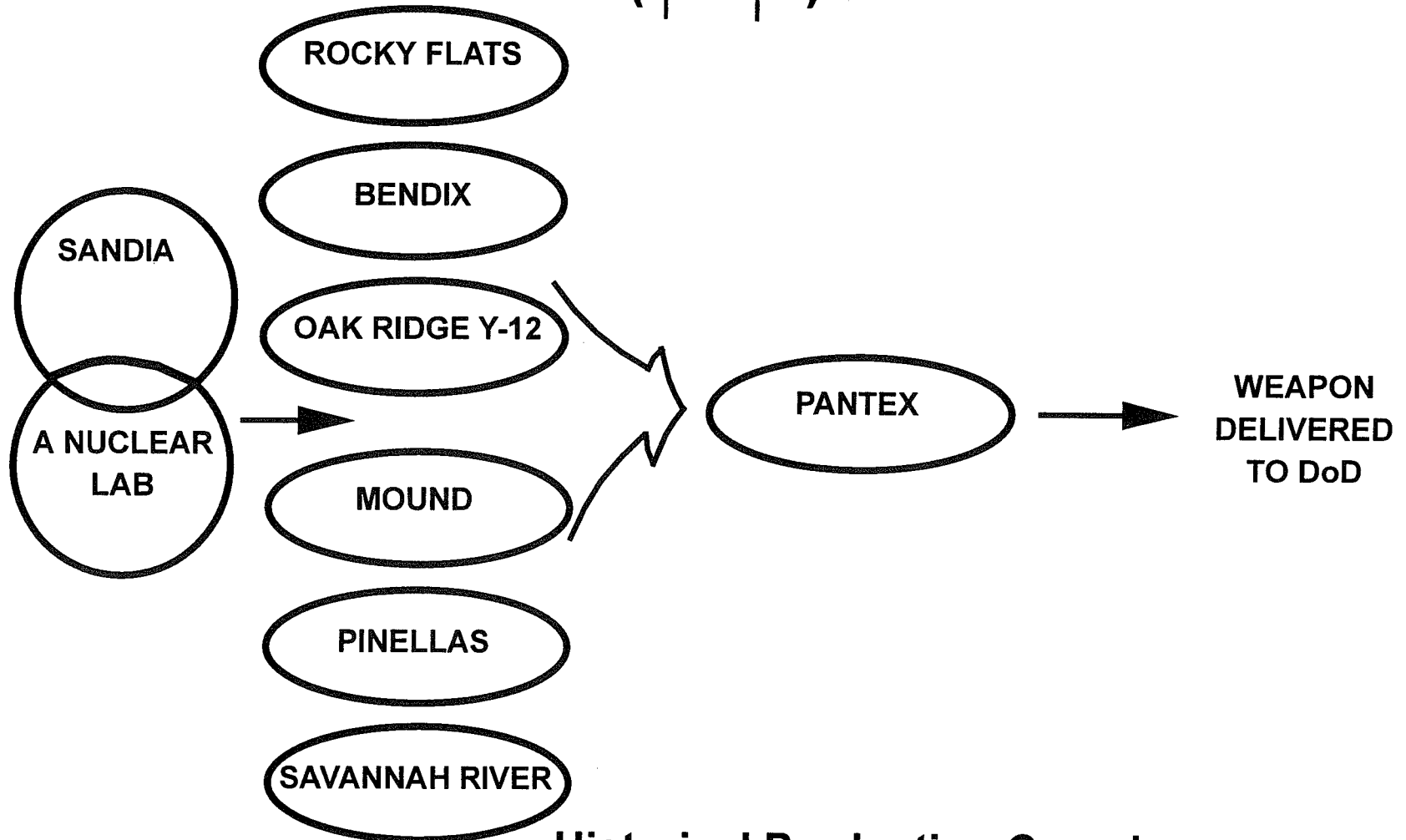

- Historical Production Complex
- Reconfiguration Will Impact

~~SECRET~~  
UNCLASSIFIED

~~SECRET~~  
UNCLASSIFIED

#### **Phase 4 - Production Engineering**

##### **DOE**

Proceeds with production engineering of weapon, tooling, and layout of manufacturing facilities, without waiting for formal comments of DoD on the developmental design. Such guidance is integrated when received. Further prototype evaluation is performed during this phase.

Prepares product specifications for production release and furnishes these specifications to the DoD for review.

##### **DoD**

Reviews product specification.

Maintains liaison with appropriate DOE agencies on product design changes and specifications and gives appropriate guidance to DOE.

Continues evaluation of prototypes as considered necessary.

#### **Phase 5 - First Production**

##### **DOE**

Initiates manufacture of weapons according to product specifications by production tools, without waiting for DoD's comments on product specifications. DOE performs own evaluation and on basis of preliminary evaluation releases weapons to DoD for testing, training, and other purposes. Makes final evaluation and approves weapon model as suitable for standardization.

##### **DoD**

Completes operational suitability tests and makes independent evaluation of production type weapons. If weapon as designed, produced, and approved by DOE is satisfactory, approves the weapon as standard.

~~SECRET~~

UNCLASSIFIED

~~SECRET~~

UNCLASSIFIED

Phase 6 - Quantity Production and Stockpile

DOE

Brings various production facilities up to full production pursuant to DoD requirements. Maintains production, inspection and quality control programs to ensure that each article produced meets specifications.

Maintains quality assurance and functional surveillance programs to ensure the continued quality of weapons in stockpile, in accordance with current agreements with respect to stockpile operations. These programs and the data obtained thereof will be made available to the DoD.

DoD

Maintains liaison with DOE agencies at production facilities. Continues appraisal of weapon performance.

Maintains liaison with DOE to review performance and technical advances in anticipation of modernization changes.

Reviews DOE's quality assurance and functional surveillance programs and results and submits appropriate comments and recommendations to the DOE. Maintains functional surveillance program in accordance with current agreements with respect to stockpile operations.

~~SECRET~~

UNCLASSIFIED

UNCLASSIFIED

~~SECRET~~

# Phase 6 STOCKPILE SURVEILLANCE (Φ6)

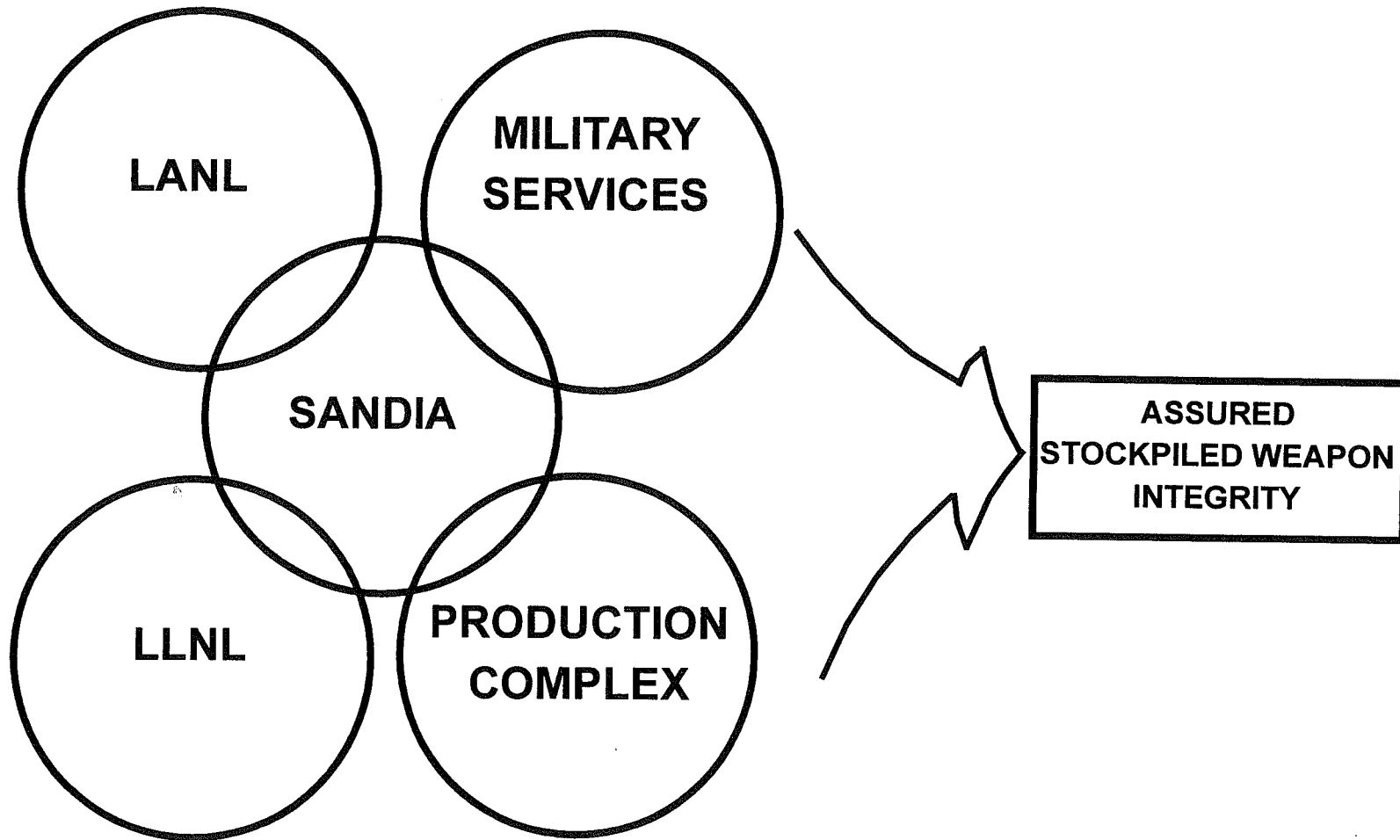

~~SECRET~~

UNCLASSIFIED

~~SECRET~~

UNCLASSIFIED

# Nuclear Weapon Life Cycle

**(The following pages are for reference. Not all of the material will be presented during the briefing)**

~~SECRET~~

UNCLASSIFIED

UNCLASSIFIED

~~SECRET~~

# WEAPON DEVELOPMENT

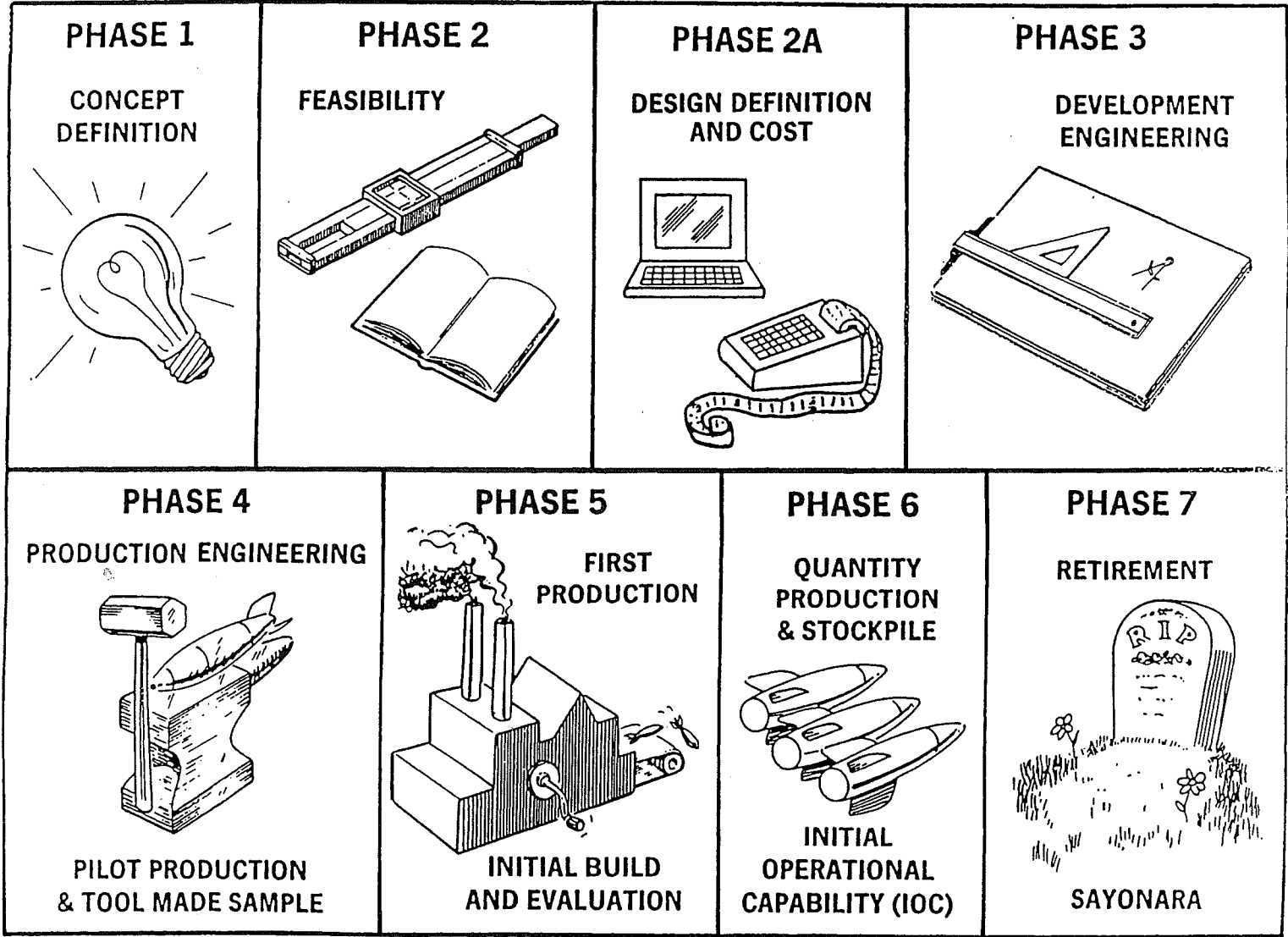

~~SECRET~~

UNCLASSIFIED

UNCLASSIFIED

~~SECRET~~

## Phase 1 -- Concept Definition

- Initiation:** Informal agreement between participants to undertake study
- Purpose:** Study a Service requirement or DOE technological breakthrough/innovation for weapon application
- Organization:** Joint DoD/DOE Study Group with appropriate working groups. (Note: it can be a DOE or DoD-only study group.) Working Groups: Surety, Requirements Analysis, Mission Analysis, Design, and Systems Engineering
- Warhead**
- Deliverables:** Phase 1 Study Report [In some cases: Draft Military Characteristics (MCs) & Draft Stockpile-to-Target Sequence (STS)]

~~SECRET~~

UNCLASSIFIED

UNCLASSIFIED

~~SECRET~~



# Phase 1 Activities

## Military Characteristics

Warhead performance requirements

Warhead physical characteristics

Requirements for nuclear safety

~~SECRET~~

UNCLASSIFIED

UNCLASSIFIED

~~SECRET~~

# Phase 1 Activities

## Stockpile-to-Target Sequence

Logistical employment concepts

Operational employment concepts

Normal & abnormal environments applicable to MC safety requirements

~~SECRET~~

UNCLASSIFIED

UNCLASSIFIED

~~SECRET~~

# Phase 1 -- Concept Definition

- Initiation:** Informal agreement between participants to undertake study
- Purpose:** Study a service requirement or DOE technological breakthrough/innovation for weapon application.
- Organization:** Joint DoD/DOE Study Group with appropriate working groups. (Note: it can be a DOE or DoD-only study group.)  
Working Groups: surety, requirements analysis, mission analysis, warhead design, and systems engineering
- Deliverables:** Phase 1 study report [In some cases: Draft Military Characteristics (MCs) & Draft Stockpile-to-Target Sequence (STS)]
- Duration & Cost:** Normally 1 year and low cost

~~SECRET~~

UNCLASSIFIED

~~SECRET~~

UNCLASSIFIED

## Phase 2 -- Weapon Feasibility

- Initiation:** Formal request from DoD [ATSD (AE)] to DOE to participate with DoD in study.
- Purpose:** Develop various weapon alternatives to fulfill service requirements.
- Organization:** Joint DoD/DOE Study Group with appropriate working groups. [Sometimes a Project Office Group, (POG) is formed.] Working Groups: Surety, requirements analysis, mission analysis, warhead design, and systems engineering.
- Deliverables:** Phase 2 study report with warhead alternatives  
Draft Military Characteristics (MCs)  
Draft Stockpile-to-Target Sequence (STS)  
Nuclear Safety & Use Control Themes  
Major Impact Report (MIR)  
Decision Cost Estimates
- Duration & Cost:** Normally 2 years and low cost.
- Parallel DoD Activities:** Milestone 1 Concept Demonstration Approval precedes Phase 2.

~~SECRET~~

UNCLASSIFIED

UNCLASSIFIED

~~SECRET~~

## Phase 2A -- Design Definition & Cost

- Initiation:** Normal included as part of Phase 2 authorization. If not, then formal ATSD (AE) request to DOE is required
- Purpose:** Develop a definitive cost estimate of the selected warhead design
- Organization:** Formal Project Officers Group with appropriate subgroups. Subgroups: Safety & Surety, Maintenance & Logistics, Command & Control, Military Characteristics, Interface, and Stockpile-to-Target Sequence, among many
- Deliverables:** Phase 2A Study Report  
Final Military Characteristics (MCs)  
Final Stockpile-to-Target Sequence (STS).  
DoD/DOE Memorandum of Understanding
- Duration & Cost:** Normally 6 months and low cost

~~SECRET~~

UNCLASSIFIED

UNCLASSIFIED

~~SECRET~~

## Phase 3 -- Development Engineering

- Initiation:** ATSD (AE) formally passes MCs, STS, and MOU to DOE/DP requesting their acceptance and requesting DOE participation in Phase 3 activities
- Purpose:** Develop a finalized and tested weapon design that meets MC and STS criteria, and that can be produced by the DOE production complex
- Organization:** Formal Project Officers Group with appropriate subgroups. Subgroups: Safety & Surety, Maintenance & Logistics, Command & Control, Military Characteristics, Interface, and Stockpile-to-Target Sequence, among many
- Deliverables:** Phase 3 Study Report  
Final tested weapon design to include all required H & T gear.
- Duration & Cost:** Normally 2.5 - 3 years and high cost
- Other Activities:** DRAAG begins its activities, reviews PWDR. JNWPS manual begun

~~SECRET~~

UNCLASSIFIED

UNCLASSIFIED

~~SECRET~~

## **Phase 4 -- Production Engineering**

- Purpose:** DOE production complex determines how it will produce the warhead. DOE production complex tools up necessary production lines
- Duration & Cost:** Normally 2.5 years and high cost
- Other Activities:** All weapons manual produced  
First generation training of military initiated  
DRAAG continues its activities, reviews IWDR

~~SECRET~~

UNCLASSIFIED

~~SECRET~~  
UNCLASSIFIED

## Phase 4 Activities

### DOE Production Complex

#### Allied Signal, Kansas City Division

Location: Kansas City Missouri

DOE Contractor: Allied Signal Corporation

#### Product:

Non-nuclear electrical, electronic, electromechanical, mechanical, plastic, and nonfissionable metal components

Pinellas - Neutron detectors, LACs, among others

Rocky Flats - Reservoirs and SST construction

Mound - Flat & round cables and ACORNS

~~SECRET~~

UNCLASSIFIED

UNCLASSIFIED

~~SECRET~~



# Phase 4 Activities

DATE

~~SECRET~~

UNCLASSIFIED

b(3)

~~SECRET~~

UNCLASSIFIED

## Phase 4 Activities

### DOE Production Complex

#### Savannah River Plant

**Location: Aiken, South Carolina**

**DOE Contractor: Westinghouse Corporation**

**Product:**

**Tritium, special isotopes, targets, and naval reactor fuel material**

**Fill boost reservoirs and ship them to the military**

**Mound - Gas transfer systems**

~~SECRET~~

UNCLASSIFIED

UNCLASSIFIED

~~SECRET~~

# Phase 4 Activities

## DOE Production Complex

### Sandia National Laboratories

Location: Albuquerque, New Mexico

DOE Contractor: Lockheed-Martin Corporation

Product:

Pinellas - Thermal batteries, neutron generators, CAP assemblies, capacitors, and frequency devices/clocks

~~SECRET~~

UNCLASSIFIED

UNCLASSIFIED

~~SECRET~~

## Phase 4 Activities

### DOE Production Complex

#### Los Alamos National Laboratory

Location: Los Alamos, New Mexico

DOE Contractor: University of California

#### Product:

Pinellas - Neutron tube target loading

Rocky Flats - Beryllium technology and pit support functions

Mound - High power detonators and calorimeters

~~SECRET~~

UNCLASSIFIED

UNCLASSIFIED

~~SECRET~~

# Phase 4 Activities

## DOE Production Complex

### Pantex Plant

Location: Amarillo, Texas

DOE Contractor: Mason & Hanger

Product:

Explosive components

Assemble all nuclear weapons

Disassemble all weapons

~~SECRET~~

UNCLASSIFIED

~~SECRET~~

UNCLASSIFIED

## Phase 4 -- Production Engineering

- Purpose:** DOE Production Complex determines how it will produce the warhead. DOE Production Complex tools up necessary production lines
- Duration & Cost:** Normally 2.5 years and high cost
- Other Activities:** All weapons manuals produced  
First generation training of military initiated  
DRAAG continues its activities, reviews IWDR

~~SECRET~~

UNCLASSIFIED

UNCLASSIFIED

~~SECRET~~

## Phase 5 -- First Production

- Purpose:** Produce initial products for new material evaluation testing. Refine production lines as a result of new material testing. Increase production rate to that required in Phase 6
- Duration & Cost:** Normally 6 months and low cost
- Other Activities:** DRAAG completes its activities. Nuclear certification of receiving service units

~~SECRET~~

UNCLASSIFIED

UNCLASSIFIED

~~SECRET~~

## **Nuclear Weapons Safety Study Group (NWSSG)**

**Chaired by Representative Service**

**Membership includes DOE, Defense Nuclear Agency, and representatives from Service Operational and Developmental Commands**

**Performs Safety Studies**

**Initial Safety Study - as early as possible in weapon development**

**Pre-operational Safety Study - at least 120 days before IOC**

**Operational Safety Review - within 2 yrs of fielding and every 5 yrs thereafter**

**Special Safety Study - whenever system changes or problems require it**

~~SECRET~~

UNCLASSIFIED

UNCLASSIFIED

~~SECRET~~



## Phase 6 -- Quantity Production & Stockpile

**Purpose:** Produce War Reserve (WR) warheads in quantities directed by the Nuclear Weapons Stockpile Memorandum (NWSM) to support military IOC

**Other Activities:** Operational activities  
Logistics activities  
Nuclear accident/incident activities  
Technical inspections of nuclear-certified units  
Stockpile quality assurance and reliability testing  
Weapon modifications and retrofits  
Inactive stockpile

~~SECRET~~

UNCLASSIFIED

~~SECRET~~

UNCLASSIFIED

# Phase 6 Activities

## Nuclear Weapon Operations

**Nuclear weapon stockpile demonstrable element of nuclear deterrent strategy**

**Ability to employ effectively**

**Surety**

**Deployment**

**Peacetime threat**

**Peacetime storage**

**Wartime threat**

**Wartime storage**

**Employment**

**Rigorously controlled process**

**Presidential release to a unified commander**

**Conveyance of presidential release to executing commander**

**Execution of nuclear mission by delivery units**

~~SECRET~~

UNCLASSIFIED

UNCLASSIFIED

~~SECRET~~

# Phase 6 Activities

## Nuclear Weapon Operations (cont.)

### Command and Control

Provides critical link and positive control by the President  
Designated communications systems  
Specific authentication procedures and codes

### Training

Ensure maximum unit and force readiness  
Exercises are still conducted

### Personnel Reliability and Assurance Program

Ensures highest possible standards of individual  
reliability  
DoD (PRP)                      DOE (PAP)

~~SECRET~~

UNCLASSIFIED

UNCLASSIFIED

~~SECRET~~

# Phase 6 Activities

## Logistics Activities

### Transportation

Logistic movements (DOE and DoD)

Operational movements (DoD)

Safety and Security are important considerations

### Storage

DOE

DoD

Security Areas

### Maintenance

Normally accomplished by the custodial service

Accomplished at weapon storage area maintenance facilities  
or in maintenance trucks (USAFE)

LLCE--boost reservoirs, neutron generators, RTGs

~~SECRET~~  
UNCLASSIFIED

UNCLASSIFIED

~~SECRET~~

# Phase 6 Activities

## Accident/Incident Activities

### **Nuclear Weapon Accident--unexpected event involving:**

**Accidental or unauthorized launching, firing, or use by US forces or U.S. supported allied forces of a nuclear capable system**

**An accidental, unauthorized, or unexplained nuclear detonation**

**Non-nuclear detonation or burning of a nuclear weapon or nuclear component**

**Radioactive contamination**

**Jettisoning of a nuclear weapon or nuclear component**

**Public hazard, actual or perceived**

### **Nuclear Weapon Significant Incident--unexpected event involving:**

**Evident damage to a nuclear weapon**

**Immediate action for safety or security**

**Adverse public reaction**

**A situation that could lead to a nuclear weapon accident**

### **Accident/Incident Response Preparation**

**DoD (EOD) and DOE (ARG) personnel continuously trained**

**EOD manual and ARG procedures kept updated**

**Joint DoD/DOE Accident/Incident training exercises held**

~~SECRET~~

UNCLASSIFIED

UNCLASSIFIED

~~SECRET~~

## Phase 6 Activities

### Technical Inspections

Performed by Service or Field Command, Defense Nuclear Agency teams

Conducted at least annually

Used to recertify nuclear capable units

Emphasis on safety as well as operational requirements

~~SECRET~~  
UNCLASSIFIED

UNCLASSIFIED

~~SECRET~~

# Phase 6 Activities

## Stockpile Quality Assurance and Reliability Testing

Begun after the system has been in the field for a year

Consists of two types of testing:

Stockpile Laboratory Testing (SLT)

Stockpile Flight Testing (SFT)

Used to include Stockpile Confidence Testing (SCT), but the UGT Moratorium has effectively canceled them

Each year test units chosen at random from the active stockpile

Test units disassembled at Pantex Plant

Non-nuclear components tested via SLT and SFT

One nuclear physics package testing non-nuclearly at physics lab

All but one test unit rebuilt and returned to the field

Each Service tests non-DOE system components

~~SECRET~~

UNCLASSIFIED

UNCLASSIFIED

~~SECRET~~

## Phase 6 Activities

### Weapon Modification and Retrofits

Can be done in the field or at Pantex Plant

Modifications and retrofits usually incorporate new technology to increase weapon safety and/or reliability

~~SECRET~~

UNCLASSIFIED

UNCLASSIFIED

~~SECRET~~



# Phase 6 Activities

## Inactive Stockpile (IS)

DoD  
6(2)

DoE  
6(3)

~~UNCLASSIFIED~~

~~UNCLASSIFIED~~

~~SECRET~~

~~SECRET~~

Components may be stored to upgrade IS weapons to the status of the same weapons in the active stockpile

## Phase 7-- Retirement

**Purpose:** To identify warheads to leave the active stockpile and to be dismantled by the Doe Productive Complex

**Other Activities:** Temporary storage of retired weapons by military is required as Pantex cannot accept all retired warheads  
Proper disposal of dismantlement waste stream  
Storage of nuclear components at Pantex due to inability to dispose of them  
Special nuclear material is reclaimed and retained

~~SECRET~~

UNCLASSIFIED

UNCLASSIFIED

~~SECRET~~

# DOD and DOE Acquisition

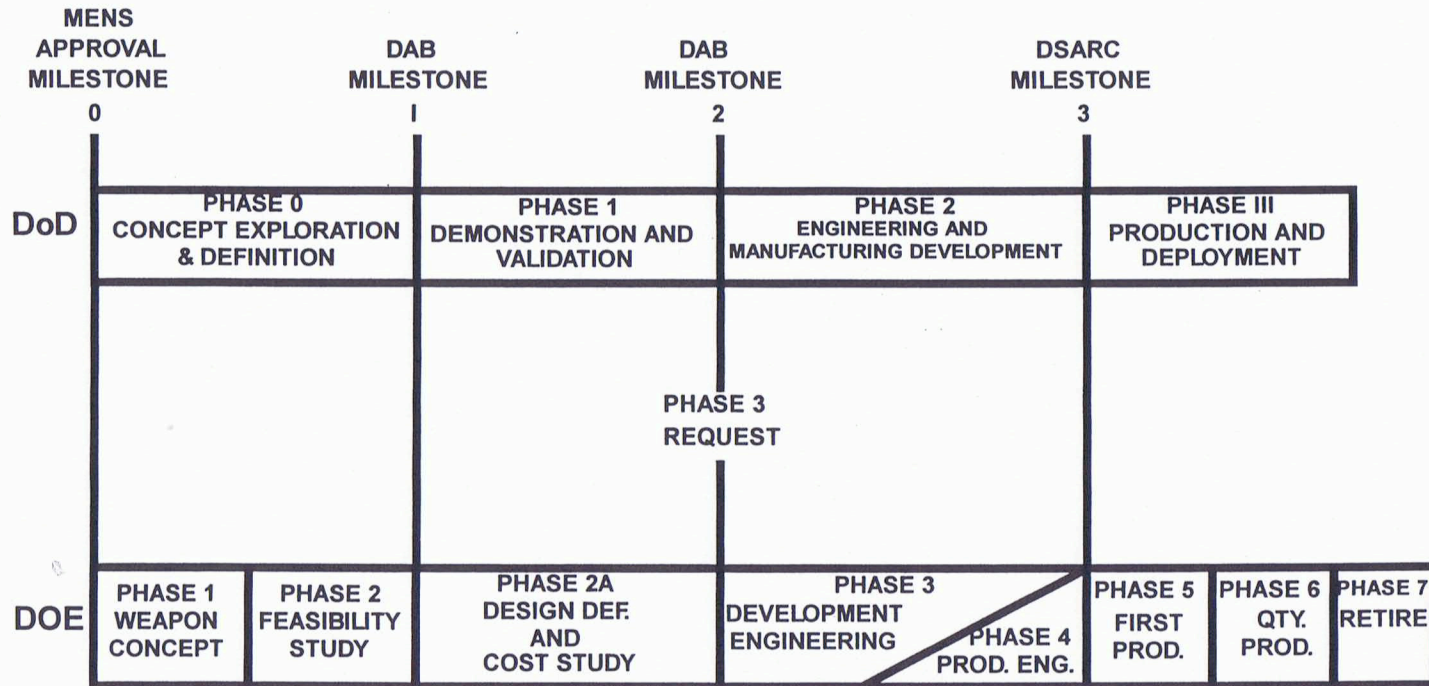

~~SECRET~~

UNCLASSIFIED

~~SECRET~~

UNCLASSIFIED

# ANNUAL STOCKPILE PAPER

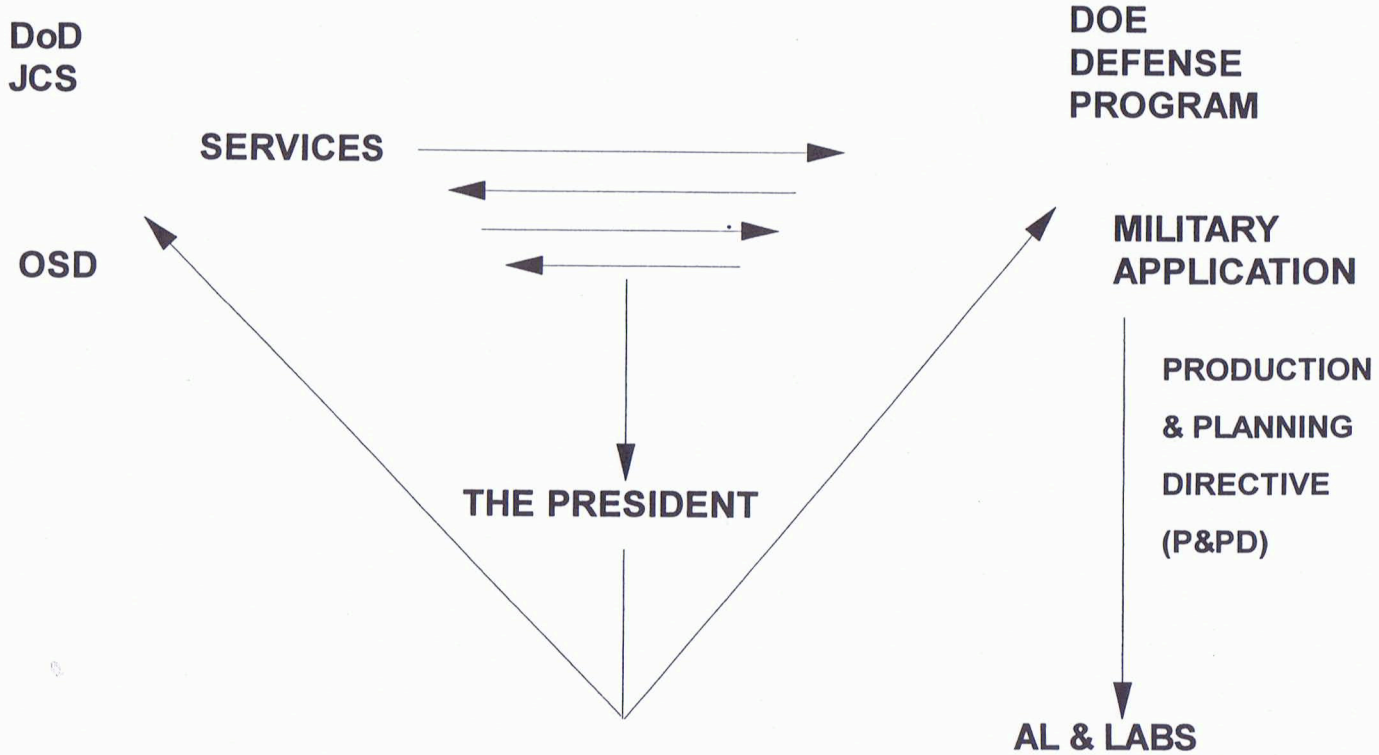

LOOKS 11 YEARS AHEAD FOR PLANNING  
 AUTHORIZED 5 YEARS OF PRODUCTION  
 AND LONG LEAD PROCUREMENT  
 DoD & DOE MAY ADJUST UP TO 10%

~~SECRET~~

UNCLASSIFIED

UNCLASSIFIED

~~SECRET~~

# REFERENCES

AN AGREEMENT BETWEEN THE AEC AND THE DoD FOR THE DEVELOPMENT, PRODUCTION, AND STANDARDIZATION OF ATOMIC WEAPONS. MAR. 21, 1953 - SUPPLEMENT DATED SEPT. 5, 1984.

A MEMORANDUM OF UNDERSTANDING BETWEEN THE ERDA AND THE DoD ON NUCLEAR WEAPONS DEVELOPMENT LIAISON PROCEDURES. SEPT. 4, 1974.

STATEMENT OF THE DIVISION OF EQUIPMENT AND RESPONSIBILITIES BETWEEN THE AEC AND THE ARMED FORCES. MAR. 1954 (DMA & ASWOP).

DoD DIRECTIVES 3150.1 AND 5030.55.

FUNDING AND MANAGEMENT ALTERNATIVES FOR ERDA MILITARY APPLICATION AND RESTRICTED DATA FUNCTIONS. ERDA 97, (SRD) JANUARY 1976.

PLANT MISSION POLICY, PART II ALO RS3172-3/08333.

~~SECRET~~

UNCLASSIFIED

~~SECRET~~

UNCLASSIFIED

# GLOSSARY

<b>ABM</b>	Anti Ballistic Missile
<b>ACDA</b>	Arms Control and Disarmament Agency
<b>ADM</b>	Atomic Demolition Munition
<b>AEC</b>	Atomic Energy Commission - then ERDA, now DOE
<b>AF&amp;F</b>	Arming, Fuzing and Firing
<b>AFAP</b>	Artillery Fired Atomic Projectile
<b>AFWL</b>	Air Force Weapons Laboratory - now Phillips Laboratory
<b>AK</b>	Adaptation Kit
$\alpha$	Alpha (Neutron Multiplication Rate)
<b>ALCM</b>	Air Launched Cruise Missile
<b>AL</b>	Albuquerque Operations Office
<b>AMAC</b>	Aircraft Monitor and Control
<b>ASDP</b>	Assistant Secretary (DOE) for Defense Programs
<b>ATSD (AE)</b>	Assistant to the Secretary of Defense for Atomic Energy
<b>AWLPG</b>	AL Workload Planning Guidance
<b>Barn</b>	Unit of cross section - $10^{-24}$ cm <sup>2</sup>
<b>Boosting</b>	The use of deuterium/tritium to increase primary yield
<b>Burnt Orange</b>	The colors of a well-known outstanding university
<b>CAT (A,B,C,D,E, or F) PAL</b>	Permissive Action Link - code controlled open switch in the weapons arming circuit. Characteristics as defined in the "General Characteristics" of PAL definition
<b>CD</b>	Command Disable (locally initiated disablement of a nuclear weapon. Not, certificate of deposit, but can be command destruct

~~SECRET~~

UNCLASSIFIED

UNCLASSIFIED

~~SECRET~~

<b>CDU</b>	Capacitor Discharge Unit
<b>CEP</b>	Circular Error Probable; circle within which 50% of the weapons are expected to hit
<b>Channel</b>	The space around the secondary and between the primary and secondary but inside the radiation case
<b>CHE</b>	Conventional High Explosive (means non-IHE)
<b>CINC</b>	Commander-in-Chief
<b>CNWDI</b>	Critical Nuclear Weapon Design Information - a DoD category of Secret RD information or higher pertaining to sensitive weapon design information; not, Caught Naked While Driving Intoxicated
<b>Critical Mass</b>	The minimum amount of fissionable material capable of supporting a chain reaction under precisely specified conditions
<b>CTB</b>	Comprehensive Test Ban
<b>DAB</b>	Defense Acquisition Board
<b>DASMA</b>	Deputy Assistant Secretary for Military Applications
<b>Depleted Uranium</b>	Uranium which has had much of the isotope U <sup>235</sup> removed; essentially U <sup>238</sup>
<b>Destruct</b>	<u>Normally</u> refers to the intentional destruction of a weapon by the high order detonation of the weapons HE at a single point
<b>Disablement</b>	Usually nonviolent actions taken on weapon hardware to prevent normal use. Disablement and destruct normally differ in degree
<b>DMA</b>	Directory of Military Application - now DASMA
<b>DNA</b>	Defense Nuclear Agency
<b>DoD</b>	Department of Defense
<b>DRAAG</b>	Design Review and Acceptance Group
<b>EBW</b>	Exploding BridgeWire (Detonator)
<b>EMP</b>	Electromagnetic Pulse

~~SECRET~~  
UNCLASSIFIED

UNCLASSIFIED

~~SECRET~~

UNCLASSIFIED

~~SECRET~~

80

EMR, EMI	Electromagnetic Radiation, Electromagnetic Interference
ENDS	Enhanced Nuclear Detonation Safety
Enhanced Electrical Safety	Embodiment of the exclusion region, strong-link, weak-link, unique signal concept (ENDS)
EOD	Explosive Ordnance Disposal
EP	Earth Penetrator
ER	Enhanced Radiation - usually neutron enhancement
ERDA	Energy Research Development Administration - was AEC, now DOE
ESD	Environmental Sensing Device
FEBA	Forward Edge of Battle Area - now FLOT
FLOT	Forward line of troops
FPU	First Production Unit
FRD	Formerly Restricted Data. Same as RD for foreign nationals
FRP	Fire Resistant Pit
Fuze	Component or subsystem that triggers the firing set. Use of fuse will likely bring abuse on you from old fuzing heads
FY	Fiscal Year
GLCM	Ground Launched Cruise Missile
HE	High Explosive
HOB	Height of Burst - vertical distance from the Earths surface to the point of burst
ICBM	Intercontinental Ballistic Missile
IFI	In-Flight-Insertion (mechanism)
IHE	Insensitive High Explosive - some form of TATB
INC	Insertable Nuclear Capsule
INF	Intermediate Range Nuclear Forces

UNCLASSIFIED

~~SECRET~~



UNCLASSIFIED

~~SECRET~~

**Interstage Area  
Intrinsic Radiation**

The space between the primary and secondary  
Naturally occurring neutron and gamma radiation present at the surface of a  
weapon

**IOC**

Initial Operational Capability

**JAIEG**

Joint Atomic Information Exchange Group

**JCAE**

Joint Committee Information Exchange Group

**JCS**

Joint Chiefs of Staff

**JTA**

Joint Test Assembly

**KT**

Kiloton equivalent of TNT hydrodynamic yield

**LANL**

Los Alamos National Laboratory

**Lay-down**

A form of weapon delivery and/or fuzing. Parachute delivered bomb from very low  
altitudes with delayed groundburst using a timer fuze

**Limited Stockpile Item**

A stockpiled weapon which has not been accepted as a "standard" item and for  
which the DoD has requested additional development

**LLC**

Limited Life Component; component which must be periodically replaced due to  
aging

**LLNL**

Lawrence Livermore National Laboratory

**LPO**

Lead Project Officer

**LRNTF**

Long Range Theater Nuclear Forces

**MA**

Military Application (DOE) - usually refers to the DASMA office or staff

**MAR**

Major Assembly Release; SNL prepared, AL approved statement that war reserve  
weapon material is satisfactory for release on a designated date to the DoD for  
specified use qualified by exceptions and limitations

**MIR**

Major Impact Report

**MIRV**

Multiple Independently Targetable Reentry Vehicle

~~SECRET~~  
UNCLASSIFIED

**Mk#** Mark Number. The system of certifying nuclear weapons and RV/RBs, cars, and other assorted goods (like TV programs!) For nuclear weapons - now replaced by W for Warhead and B for Bomb or other

**MLC** Military Liaison Committee - historically was the coordinating and interchange of information focus between DoD and DOE

**MRR** Minimum Residual Radiation - now RRR

**MRV** Multiple Reentry Vehicle

**MT** Megaton, million tons equivalent TNT. Also metric tons - 1000 kilograms

UNCLASSIFIED

~~SECRET~~

DATE

( )

~~SECRET~~

UNCLASSIFIED

**OMA** Office of Military Application - now office of DASMA

**OMB** Office of Management and Budget

**One Point** The detonation of the weapon HE at a single point

~~SECRET~~

UNCLASSIFIED

Oy	Oralloy - Oak Ridge Alloy. Uranium enriched in the isotope $U^{235}$ to 93.5%
OSD	Office of the Secretary of Defense
PL	Phillips Laboratory (formerly Air Force Weapons Lab)
PAL	Permissive Action Link - coded use control feature
PA&E	Program Analysis and Evaluation, OSD, (not program annihilation and elimination)
P&PD	Production and Planning Directive
P&S	Production and Surveillance
PM-NUC	Program Manager - Nuclear Munitions (Army program office for nuclear-no longer active)
POC	Programs of Cooperation
POG	Project Officers Group
POM	Meeting of the POG
Primary	The "fission" device
Pu	Plutonium, a reactor produced fissionable material obtained by bombarding $U^{238}$ with neutrons
QA	Quality Assurance - DoD uses QART—Quality Assurance, Reliability Testing
QRA	Quick Reaction Alert; weapon system deployed in a state that would allow its employment in a stated minimum specified time
RB	Reentry Body - Navy term for RV
RD	Restricted Data; all data concerning design, manufacture, or utilization of nuclear weapons and the production of special nuclear material which has not been removed by the Atomic Energy Act of 1954
Rolomite	A Sandia designed ESD sensor
RRR	Reduced Residual Radiation - reduced fission devices—formerly MRR (Minimum Residual Radiation)
RTG	Radioisotopic Thermoelectric Generator

~~SECRET~~

UNCLASSIFIED

<b>RV</b>	Reentry Vehicle Army, Air Force - Navy calls them RBs, definitely not a recreational vehicle
<b>SAC</b>	Strategic Air Command
<b>Secondary</b>	The "thermonuclear" device
<b>Sec Def</b>	Secretary of Defense
<b>Shake</b>	10 <sup>-8</sup> seconds
<b>SLBM</b>	Submarine Launched Ballistic Missile
<b>SLCM</b>	Sea Launched Cruise Missile
<b>SNL</b>	Sandia National Laboratories
<b>SNM</b>	Special Nuclear Material - Pu, Oy
<b>SP</b>	Strategic Programs - Navy SLBM office
<b>Specified Command</b>	Combat command with a broad and continuing mission - usually a single service such as the Strategic Air Command
<b>SRAM</b>	Short Range Attack Missile
<b>SS Material</b>	Source Strength Material - DOE audits one kilogram quantities (includes depleted and natural uranium)
<b>SSPO</b>	Strategic Systems Program Office - now SP
<b>Standard Stockpile Item</b>	A nuclear weapon which meets the approved military characteristics to DoD's satisfaction
<b>Stockpile Nuclear Test</b>	QA test of a system withdrawn from the stockpile. That rare instance that a stockpiled weapon is tested downhole at NTS - a stockpile "confidence test"
<b>STS</b>	Stockpile-to-Target Sequence
<b>TATB</b>	Triamino-Trinitro-Benzene; see IHE
<b>TTR</b>	Tonopah Test Range - Sandia's testing range at Tonopah, Nevada

~~SECRET~~

UNCLASSIFIED

UNCLASSIFIED

~~SECRET~~

<b>TREE</b>	Transient radiation effects on electronics
<b>Tritium</b>	Third isotope of hydrogen, radioactive gas used to boost weapons
<b>TTBT</b>	Threshold Test Ban Treaty
<b>Tu</b>	Tuballoy - natural uranium. Sometimes also includes depleted uranium, i.e., essentially U <sup>238</sup>
<b>V-γ Map</b>	A contour depicting permissible velocity and reentry angle combinations for a missile RV/RB
<b>Unified Command</b>	A combat command with a broad and continuing mission composed of forces of two or more services under a single commander
<b>USANCA</b>	U.S. Army Nuclear and Chemical Agency
<b>USDR&amp;E</b>	Under Secretary of Defense for Research and Engineering
<b>WR</b>	War Reserve nuclear weapons material (in DOE or DoD custody) intended for employment in the event of war
<b>Weapons Grade Pu</b>	Plutonium which has 6% or less Pu <sup>240</sup> content; Pu <sup>239</sup> is the good stuff
<b>WDCR</b>	Weapon Design and Cost Report
<b>WES</b>	Warhead Electrical System
<b>WS<sup>3</sup></b>	Weapon Secure, Safe, Storage
<b>WSV</b>	Weapons Storage Vault (Weapons Security Vault)
<b>X-unit</b>	A device used to provide energy to initiate nuclear system detonators

~~SECRET~~

UNCLASSIFIED

UNCLASSIFIED

~~SECRET~~

## WEAPONS/WEAPON APPLICATIONS

<u>WEAPON*</u>	<u>APPLICATION</u>	<u>SERVICE</u>
FATMAN	BOMB	AF
LITTLEBOY	BOMB	AF
Mk III	BOMB	AF
Mk 4	BOMB	AF
T-4	ATOMIC DEMONITION MUNITION	A
Mk 5	BOMB	AF,N
Mk 5	MATADOR	AF
Mk 5	REGULUS I	N
Mk 6	BOMB	AF
Mk 7	BOMB	AF,N
Mk 7	HONEST JOHN	A
Mk 7	CORPORAL	A
Mk 7	BOAR	N
Mk 7	BETTY	N
Mk 7	ATOMIC DEMONITION MUNITION	A
Mk 7	NIKE HERCULES	A
Mk 8	BOMB	N
Mk 9	280-mm AFAP	A
Mk 11	BOMB	N

\*Absence of entry indicates system not fielded

UNCLASSIFIED

~~SECRET~~

UNCLASSIFIED

~~SECRET~~

~~SECRET~~

UNCLASSIFIED

<u>WEAPON</u>	<u>APPLICATION</u>	<u>SERVICE</u>
Mk 12	BOMB	AF,N
Mk 14	BOMB	AF
Mk 15	BOMB	AF,N
Mk 17	BOMB	AF
Mk 18	BOMB	AF,N
Mk19	280-mm AFAP	A
Mk21	BOMB	AF
Mk23	16" AFAP	N
B24	BOMB	AF
W25	GENIE	AF
B27	BOMB	N
W27	REGULUS I	N
B28	BOMB	AF,N
W28	HOUNDDOG	AF
W28	MACE	AF
W30	TALOS	N
W30	ATOMIC DEMONITION MUNITION	A
W31	HONEST JOHN	A
W31	NIKE HERCULES	A
W31	ATOMIC DEMONITION MUNITION	A
W33	8" PROJECTILE	A,N

UNCLASSIFIED

~~SECRET~~

<u>WEAPON</u>	<u>APPLICATION</u>	<u>SERVICE</u>
W34	LULU	N
W34	ASTOR	N
B34	HOTPOINT	N
B36	BOMB	AF
W38	ATLAS	AF
W38	TITAN I	AF
B39	BOMB	AF,N
W39	B-58 pod	AF
W39	REDSTONE	A
W39	SNARK	AF
W40	BOMARC	AF
W40	LACROSSE	A
B41	BOMB	AF
B43	BOMB	N,AF
W44	ASROC	N
W45	BULLPUP	N
W45	TERRIER	N
W45	LITTLE JOHN	A
W45	MADM.	A
W47	POLARIS	N
W48	155-mm AFAP	A,N

**SECRET**

UNCLASSIFIED

UNCLASSIFIED

**SECRET**



~~SECRET~~

UNCLASSIFIED

<u>WEAPON</u>	<u>APPLICATION</u>	<u>SERVICE</u>
W49	ATLAS	AF
W49	THOR	AF
W49	JUPITER	A,AF
W49	TITAN I	AF
W50	PERSHING	A
W50	NIKE ZEUS	A
W52	SERGEANT	A
W53	BOMB	AF
W53	TITAN II	AF
W54	FALCON	AF
W54	DAVY CROCKETT	A
W54	SADM	A,N
W55	SUBROC	N
W56	MINUTEMAN	AF
B57	BOMB/DEPTH BOMB	AF,N
W58	POLARIS A3	N
W59	MINUTEMAN I	AF
B61	BOMB	AF,N
W62	MINUTEMAN II	AF
W66	SPRINT	A
W68	POSEIDON C3	N
W69	SRAM	AF

UNCLASSIFIED

~~SECRET~~

WEAPONAPPLICATIONSERVICE

W70	LANCE	A
W71	SPARTAN	A
W72	WALLEYE	AF
W76	TRIDENT I	N
W78	MINUTEMAN III	AF
W79	8" AFAP	A,N
W80	SLCM	N
W80	ALCM	AF
B83	BOMB	AF
W84	GLCM	AF
W85	PERSHING II	A
W87	PEACEKEEPER ICBM	AF
W88	TRIDENT II	N

~~SECRET~~

UNCLASSIFIED

UNCLASSIFIED

~~SECRET~~

# SURVEY OF WEAPONS DEVELOPMENT AND TECHNOLOGY

WR708

SESSION II

- REVIEW OF WEAPONS PHYSICS
- THEORY OF NUCLEAR EXPLOSIONS

~~SECRET~~

UNCLASSIFIED

UNCLASSIFIED

~~SECRET~~

# Weapons Physics and Nuclear Material

---

- Several basic nuclear physics concepts and the properties of the nuclear fissile material are very important to the understanding of weaponization
- The physics of fission
- Nuclear properties
- Availability of material
- How the fissile material is obtained
- Energy available and energy trades

~~SECRET~~

UNCLASSIFIED

UNCLASSIFIED

~~SECRET~~

~~SECRET~~

UNCLASSIFIED

# NUCLEAR BINDING ENERGY

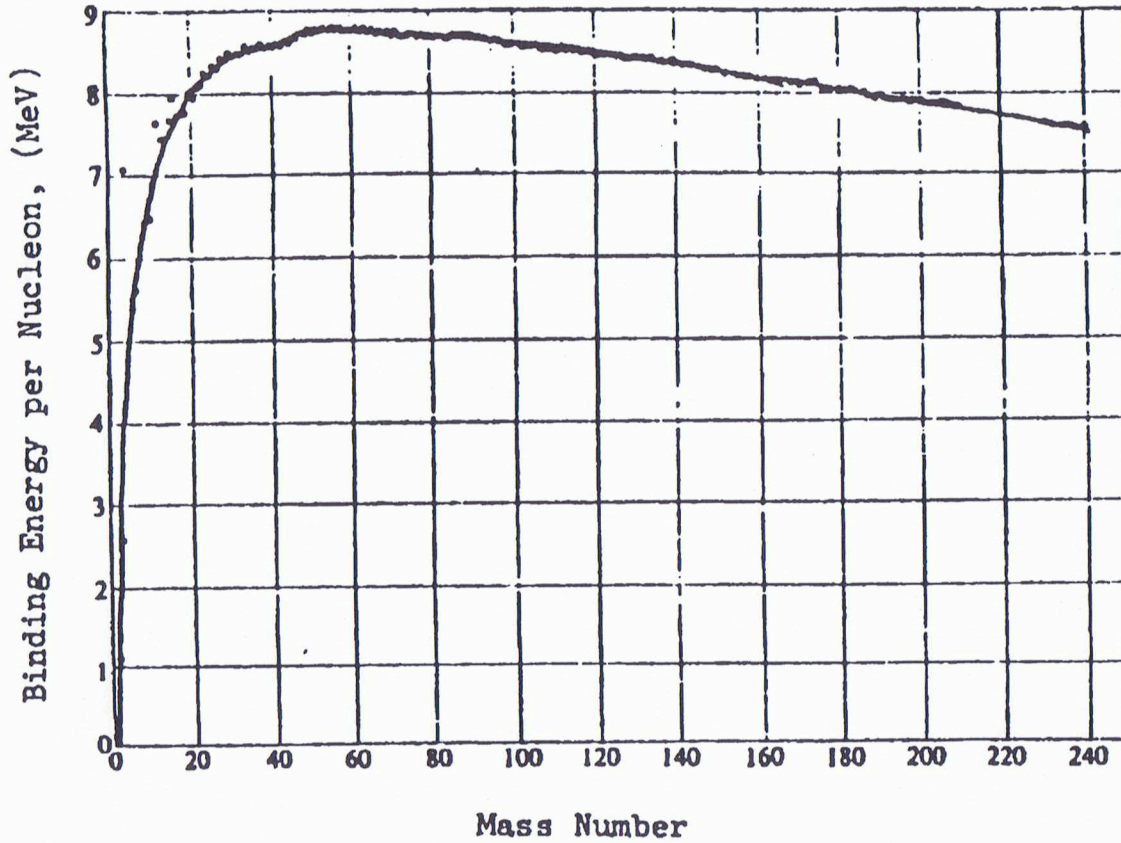

UNCLASSIFIED

~~SECRET~~

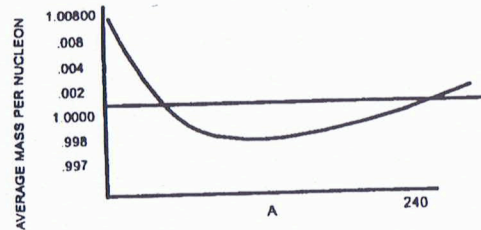

# LIQUID DROP MODEL APPLIED TO POTENTIAL BARRIERS

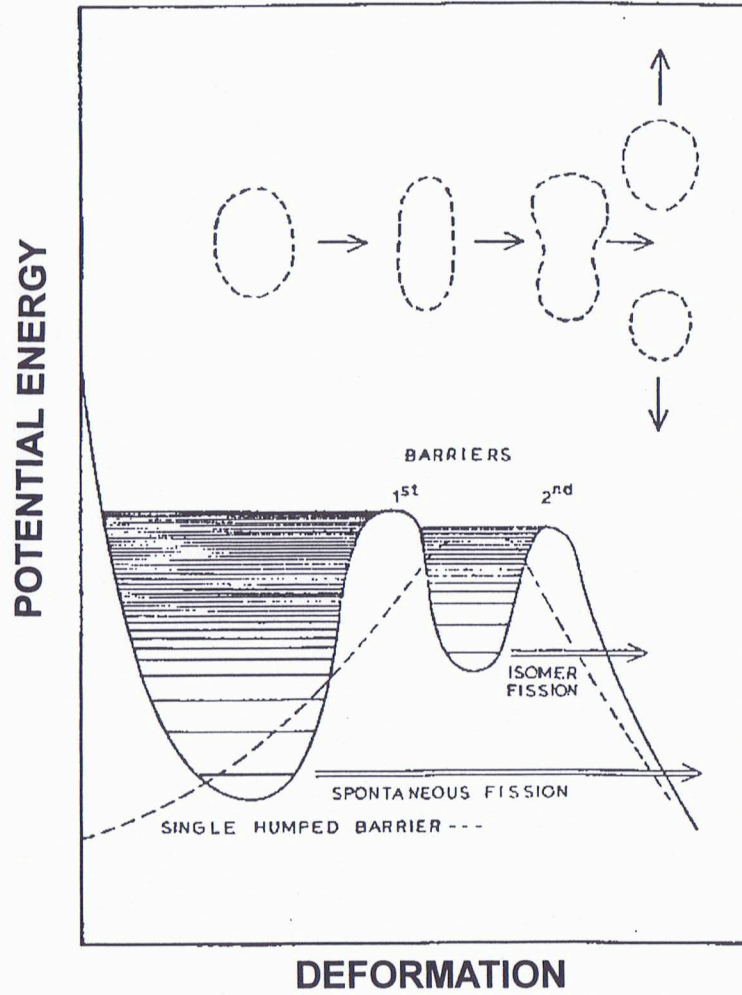

~~SECRET~~

UNCLASSIFIED

UNCLASSIFIED

~~SECRET~~

~~SECRET~~

UNCLASSIFIED

## CHARGE DISTRIBUTION CURVE

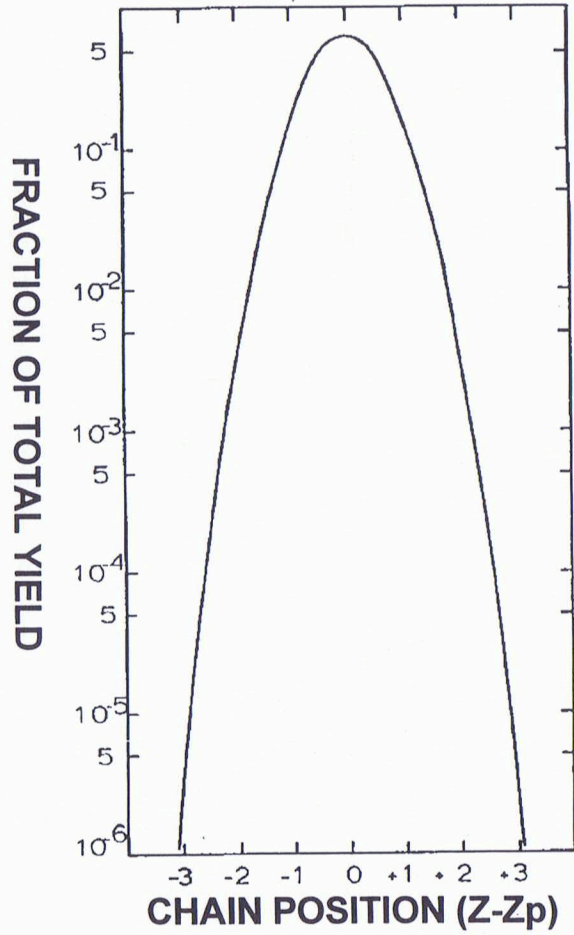

UNCLASSIFIED

~~SECRET~~

~~SECRET~~

UNCLASSIFIED

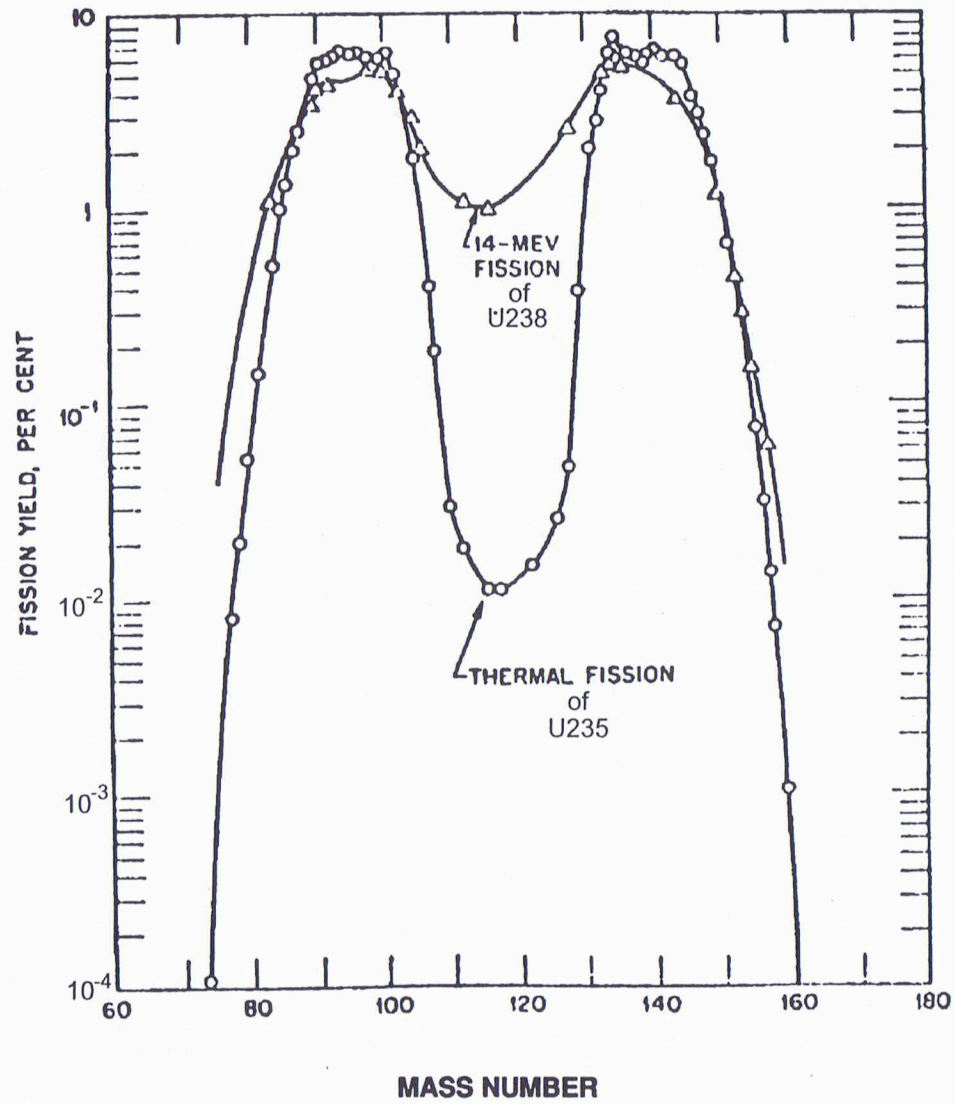

LIKELIHOOD FOR FISSION FRAGMENT

UNCLASSIFIED

~~SECRET~~



~~SECRET~~

UNCLASSIFIED



0012  
b(3)

UNCLASSIFIED

~~SECRET~~

b(3)

# Terminology

- Asymmetric fission** - division of excited nucleus into two unequal fragments with masses about 100 & 140 amu.
- Binary** - division at scission point into two parts.
- Cross-Section** - probability that a certain reaction between a nucleus and an incident particle or photon will occur, as in a neutron and  $U^{235}$  (measured in "barns")
- Fission Fragment** - fragment after scission but before prompt neutron emission
- Fission Product** - fragment after prompt neutron emission

~~SECRET~~

UNCLASSIFIED

~~SECRET~~

UNCLASSIFIED

DoE

b(3)

~~SECRET~~  
UNCLASSIFIED

b(3)

UNCLASSIFIED

~~SECRET~~

b (3)

013  
10

~~SECRET~~  
UNCLASSIFIED

~~SECRET~~ UNCLASSIFIED

# The Gang of Four

<p style="text-align: center;"><math>^{238}\text{U}_{92}</math></p> <p style="text-align: center;">% in nature - 99.27</p> <p>When the <math>^{238}\text{U}_{92}</math> is extracted, it is called depleted <math>^{238}\text{U}</math> or TUBALLOY or D38 (from UK WWII effort - TUBE ALLOY)</p> <p style="text-align: center;">Will fission but not fissile</p> <p style="text-align: center;">Physically separated</p>	<p style="text-align: center;"><math>^{239}\text{Pu}</math></p> <p style="text-align: center;">% in nature - essentially zero (mine in South Africa)</p> <p style="text-align: center;">Made in reactor: <math>n + ^{238}\text{U} = ^{239}\text{Pu}</math></p>
<p style="text-align: center;"><math>^{235}\text{U}</math></p> <p style="text-align: center;">% in nature - 00.73</p> <p style="text-align: center;">Concentrated to 93.5%</p> <p>Called ORALLOY for Oak Ridge Alloy</p>	<p style="text-align: center;"><math>^{240}\text{Pu}</math></p> <p style="text-align: center;">% in nature - essentially zero</p> <p style="text-align: center;">Made by reactor</p> <p>If you leave the <math>^{239}\text{Pu}</math> in "too long," it will absorb a n <math>\rightarrow</math> <math>^{240}\text{Pu}</math></p> <p style="text-align: center;">Spontaneously fissions (originally a problem for pre-ignition)</p>

~~SECRET~~

UNCLASSIFIED

~~SECRET~~

UNCLASSIFIED

# CALCULATION OF ENERGY RELEASE



235.0439		94.905837		
<u>1.0087</u>		138.906400		
		.003850		
		<u>2.017340</u>		
236.0526 amu	→	235.8334 amu	atomic mass unit	

MASS DEFECT OF .219 amu

n = 1.00867 amu  
 p = 1.00728 amu  
 e = .00055 amu

$$(.219 \text{ amu}) \left( 931.4 \frac{\text{MeV}}{\text{amu}} \right) \approx 204 \text{ MeV}$$

THE EXAMPLE STARTED WITH



FISSION CHAIN

~~SECRET~~

UNCLASSIFIED

UNCLASSIFIED

~~SECRET~~

# THEORETICAL FISSION ENERGY

- THERE ARE  $\frac{6.025 \times 10^{23}}{235.0439}$  ATOMS PER GRAM OF  ${}_{92}\text{U}^{235}$
- THEREFORE, 1 kg OF  ${}_{92}\text{U}^{235}$  HAS  $2.5634 \times 10^{24}$  ATOMS
- HENCE, @ 180 MeV PER FISSION 1 kg OF  ${}_{92}\text{U}^{235}$  WOULD PRODUCE  $4.6141 \times 10^{26}$  MeV IF EACH ATOM WERE FISSIONED.
- CONVERTING TO KILOTONS
- $(4.6141 \times 10^{26} \text{ MeV}) (3.824 \times 10^{-26} \frac{\text{KT}}{\text{MeV}}) \approx 18 \text{ KT}$

~~SECRET~~

UNCLASSIFIED

UNCLASSIFIED

~~SECRET~~

**FACTORS AFFECTING CRITICAL MASS**

- **GEOMETRY**
- **AMOUNT OF MATERIAL**
- **TYPE OF MATERIAL**
- **PURITY OF MATERIAL**
- **SURROUNDING MATERIAL**
- **DENSITY**

~~SECRET~~

UNCLASSIFIED

~~SECRET~~

UNCLASSIFIED



~~SECRET~~

UNCLASSIFIED

B-3



UNCLASSIFIED

~~SECRET~~

B-3

DOE  
100)

~~SECRET~~

UNCLASSIFIED

~~SECRET~~ UNCLASSIFIED

B-3

~~SECRET~~

UNCLASSIFIED

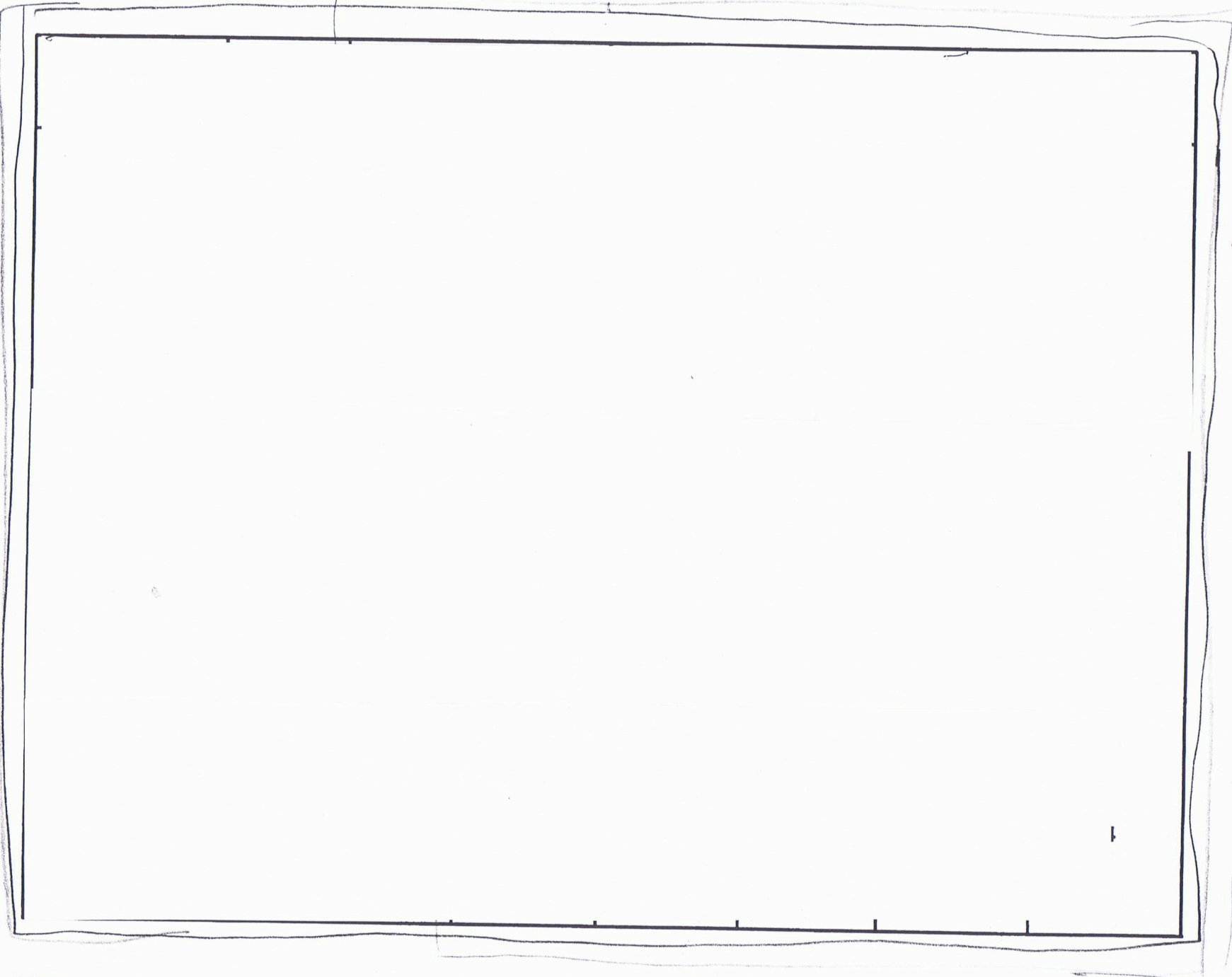

UNCLASSIFIED

~~SECRET~~

# FISSION CROSS SECTIONS

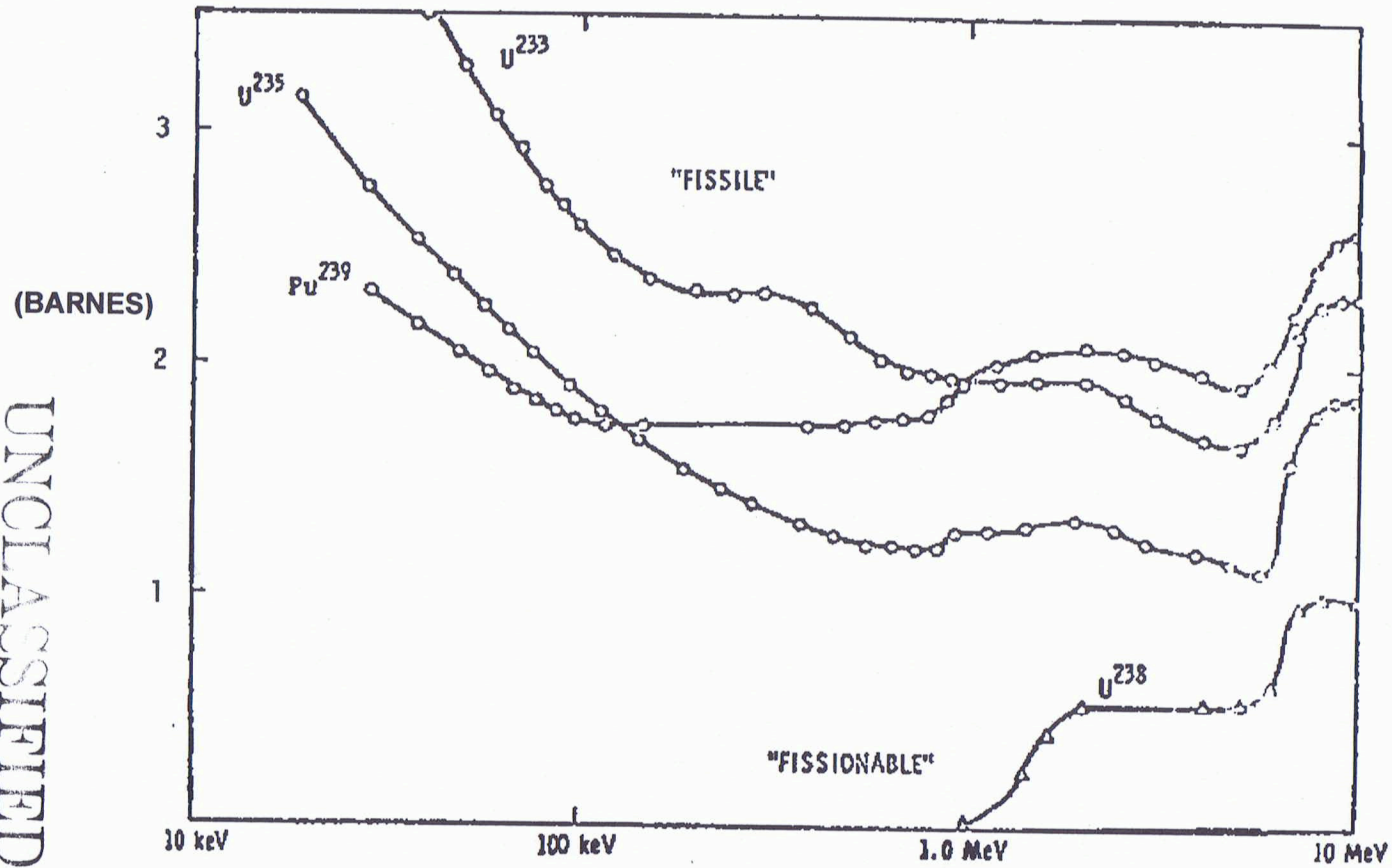

INCIDENT NEUTRON ENERGY

NOTE: The thermal neutron energy is not on the chart

~~SECRET~~

UNCLASSIFIED

UNCLASSIFIED

~~SECRET~~

~~SECRET~~

UNCLASSIFIED

UNCLASSIFIED

~~SECRET~~

# Variation of Cross Section x Ave. # Neutrons for $^{235}\text{U}$

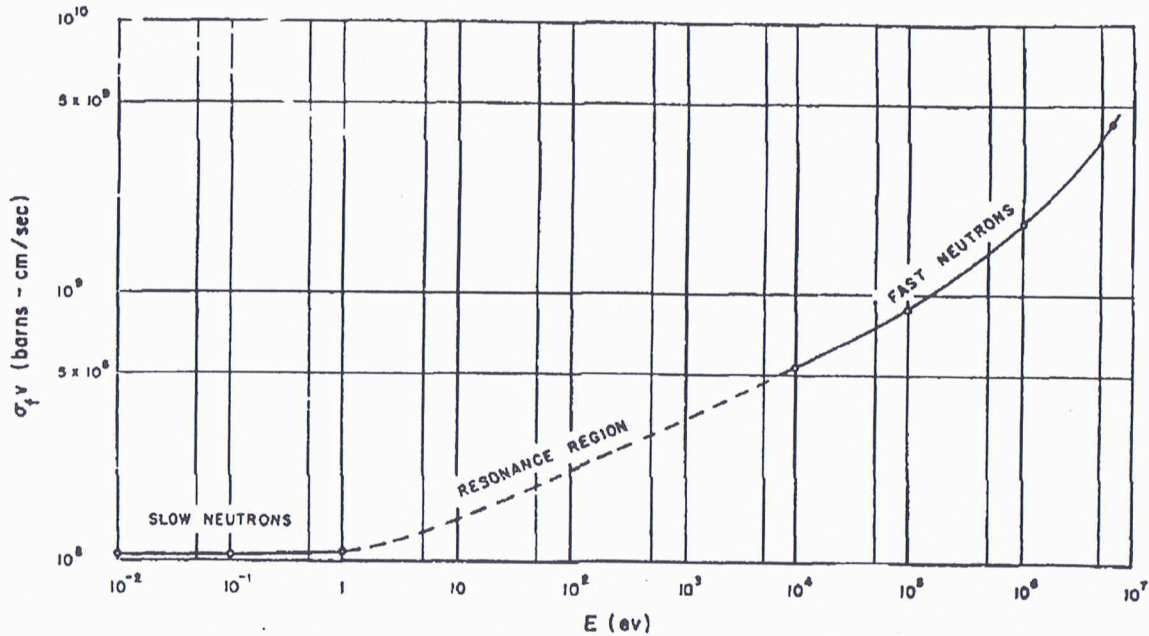

## Neutron Energy

Fission is more effective at higher energies N  
Smallest fission generation time at high energies ( $T = 1 / N\sigma_f v$ )

# Neutron Energy (MeV)

## $U_{235}$ Fission Neutron Energy Spectrum

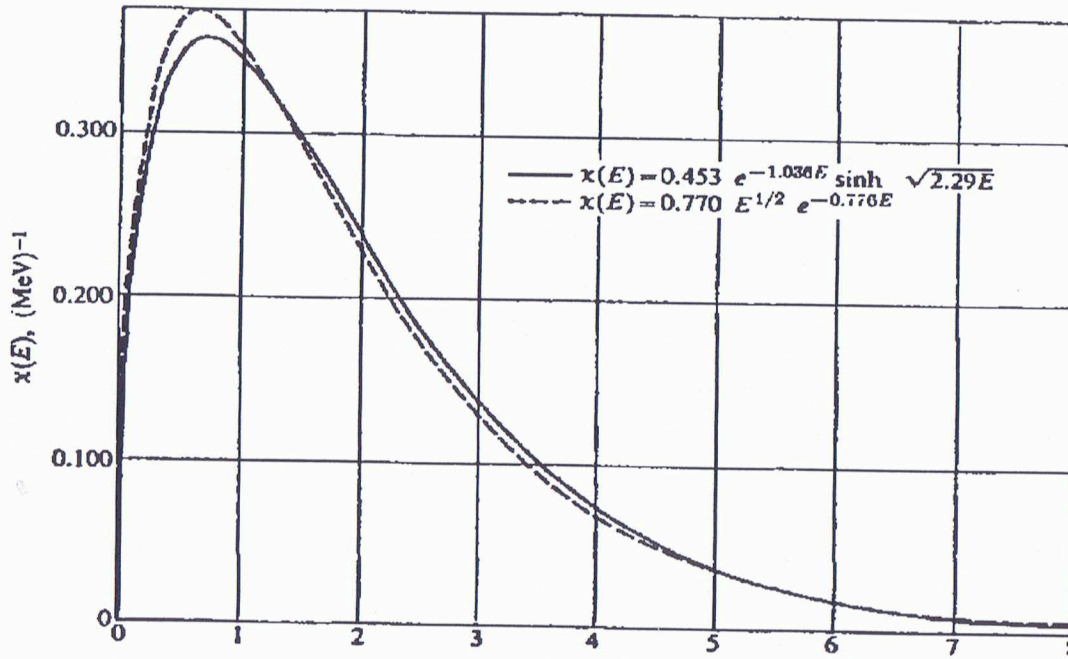

(Reference, Lamarsh, 1966)

~~SECRET~~

UNCLASSIFIED

UNCLASSIFIED

~~SECRET~~

## "A Shake"

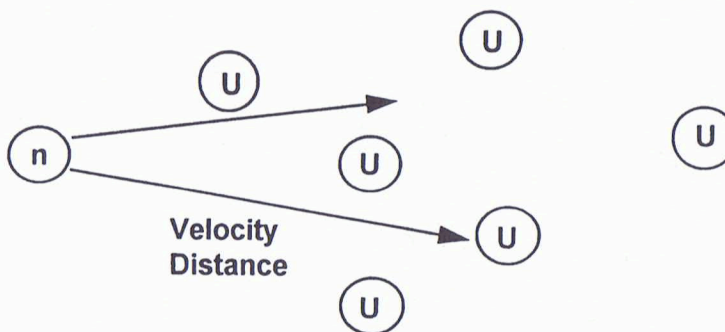

- Fission mean free path - how long before it clobbers an atom like URANIUM
- Average velocity - how fast it is going

$$\tau = \frac{\text{fission mean free path}}{\text{average velocity of neutron}}$$

These values are derived experimentally and are related to the fission cross section and velocity of the neutron.

- $\tau = 10^{-8}$  Seconds or 1 shake  
(real fast like the shake of a lamb's tail)

~~SECRET~~

UNCLASSIFIED

UNCLASSIFIED

~~SECRET~~

## We Care About Neutrons

- An efficient way to fission  $U^{235}$  or  $Pu^{239}$  is with neutrons.
- The fission of one atom of  $U^{235}$  or  $Pu^{239}$  releases approximately 200 MeV.
- To create an explosion by fission, a bunch of neutrons are required.
- The more neutrons--the more fission, i.e., We Care About Neutrons!
- Remember that each fission gives off integral numbers of neutrons--about 2-4, but over a bunch of fissions, we measure an average (i.e., 2.54 etc.) and this varies with input neutron energy.

$\nu$  = average number of neutrons

- The whole idea of sustaining the fission process is to get these fission neutrons to go fission more  $U^{235}$  or  $Pu^{239}$ .
  - If all the neutrons escape without fissioning anything, then the reaction fizzles! (The population becomes extinct.)
  - If at least one of the 2 to 4 neutrons fission something every generation, then we have a steady state condition--a reactor.
  - If most of the neutrons fission another atom etc., etc., we have a run-away condition--a nuclear explosion.

~~SECRET~~

UNCLASSIFIED

UNCLASSIFIED

~~SECRET~~



# We Care About the Neutrons that Escape

- 
- We call the escapees "lost neutrons," and the abbreviation is  $l$  (the letter after  $k$ ).
  - So the number of neutrons available for population growth is the average number per fission ( $u$ ), i.e., 2.54 minus the lost ones.
  - Someone called this  $k$ .
  - Therefore:  $k = u - l$ 
    - for every neutron causing fission in one generation  $k$  will cause it in the next generation.

~~SECRET~~

UNCLASSIFIED

UNCLASSIFIED

~~SECRET~~

## We Care About the Multiplication

---

- Now let's look at a bunch of fissions and bunch of neutrons.
- If we start with some number of neutrons (one or more), let that number equal  $n$ .

$n$  = number of neutrons at beginning of a generation

- Remember,  $k$  = number of neutrons available for Round 2...
- And  $k$  times  $n$  equals number of neutrons at the next generation.
- Don't forget we've used up the original neutrons ( $n$ ) in the first fission process..
- The gain of neutrons is thus:

$$n \cdot k - n$$

(number of neutrons we started with) • (average number in a fission of Round 2 (etc.)) minus the ones we used up in the previous round.

~~SECRET~~

UNCLASSIFIED

UNCLASSIFIED

~~SECRET~~

## Determine Growth Rate

---

- We still care about neutrons, but we really care about the rate (speed) that they are produced.
- The rate is the  $\frac{\text{change in the number of neutrons}}{\text{change in time}}$
- Mathematically this is represented

$$\frac{Dn}{Dt} \longrightarrow \frac{dn}{dt}$$

- To get the rate change, we divide the actual gain in neutrons by time (t)

$$\frac{nk - n}{t}$$

- Therefore  $\frac{dn}{dt} = \frac{nk - n}{t}$

~~SECRET~~

UNCLASSIFIED

UNCLASSIFIED

~~SECRET~~

## Apply Basic Calculus

---

- $\frac{dn}{dt} = \frac{nk - n}{\tau} = \frac{n(k-1)}{\tau}$
- Let  $\alpha$  "alpha" =  $\frac{k-1}{\tau}$  substitution gives
- $\frac{dn}{dt} = n\alpha$ ; Rearrange (cross multiply and divide)
- $\frac{dn}{n} = \alpha dt$  Integrate from zero neutrons ( $N_0$ ) to  $N$  neutrons.
- $N = N_0 e^{\alpha t}$

If  $\alpha$  is known, one can calculate the number of neutrons at any time ( $t$ ).

~~SECRET~~

UNCLASSIFIED

UNCLASSIFIED

~~SECRET~~

## The Energy Released is Proportional to the Number of Fissions

$$\alpha \approx \frac{\mu - 1 - 1}{\tau} \approx \frac{3 - 1 - 1}{\tau} \approx \frac{1}{\tau} \text{ 1 gen / shake for 1 MeV neutron}$$

where:  $\mu$  = ave# Neutrons  
 $\rho$  = Post Neutrons

$$N = N_0 e^{\alpha t} \cong N_0 e^{\frac{t}{\tau}} = e^g \text{ where } g = \text{Number of generations}$$

The energy released is proportional to the number of fissions  
The number of fissions is proportional to the number of neutrons

1 fission  $\cong 7 \times 10^{-21}$  tons of TNT

At  $g = 48$  we would have  $\approx 9800$  lbs.

~~SECRET~~

UNCLASSIFIED

UNCLASSIFIED

~~SECRET~~

b (3)

~~SECRET~~

UNCLASSIFIED

~~SECRET~~

UNCLASSIFIED

# $\alpha$ - Curve

Alpha

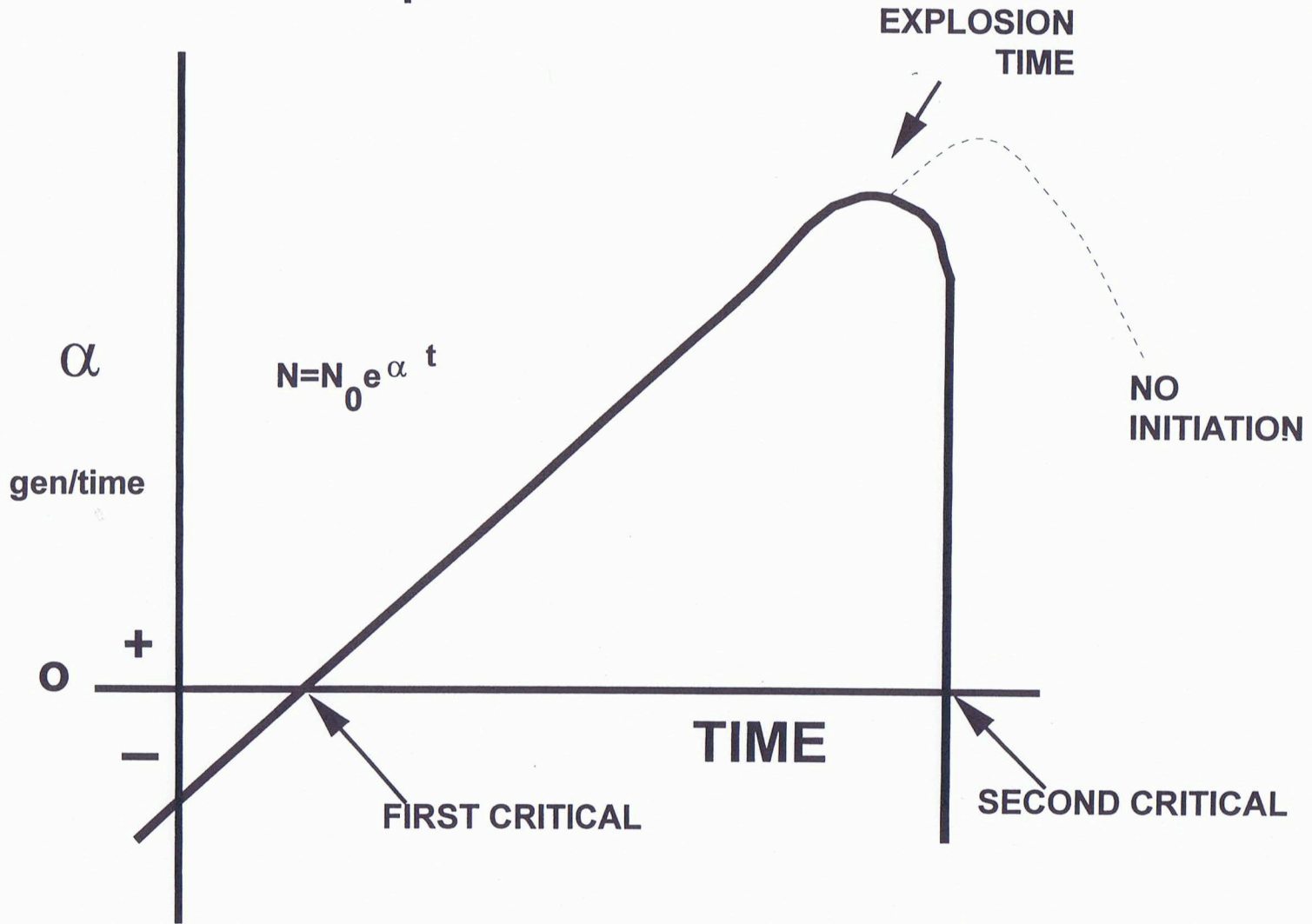

~~SECRET~~

UNCLASSIFIED

~~SECRET~~

UNCLASSIFIED

# $\alpha$ - Curve

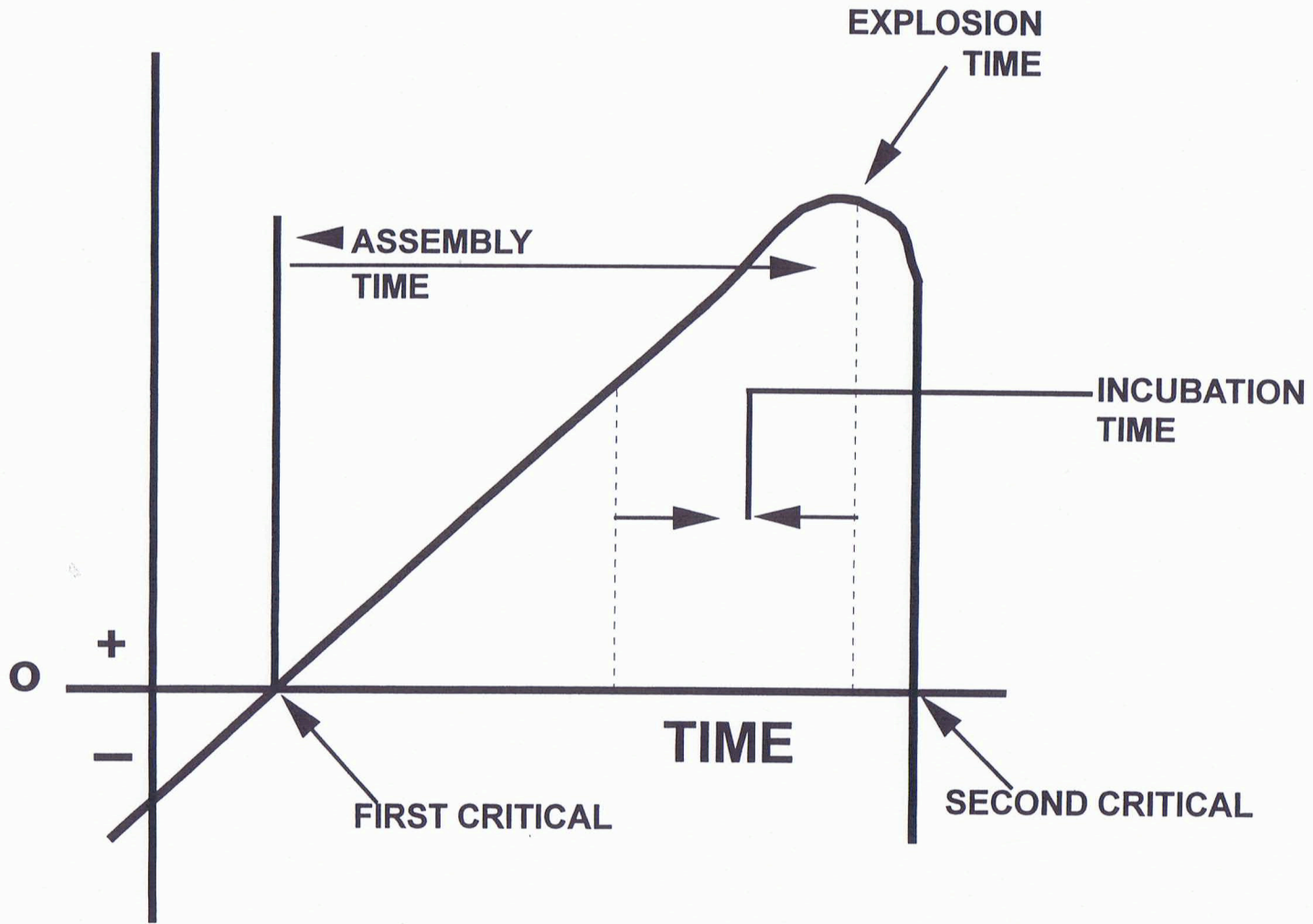

~~SECRET~~

UNCLASSIFIED

UNCLASSIFIED

~~SECRET~~



$\alpha$  - Curve

FOI

b6)

~~SECRET~~

UNCLASSIFIED

~~SECRET~~

UNCLASSIFIED

# NUCLEAR BINDING ENERGY

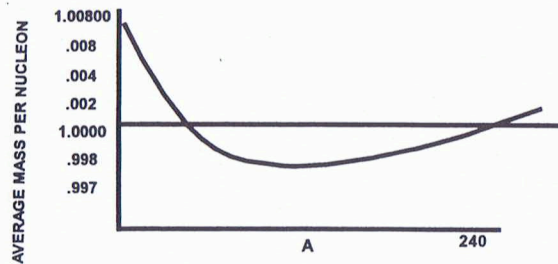
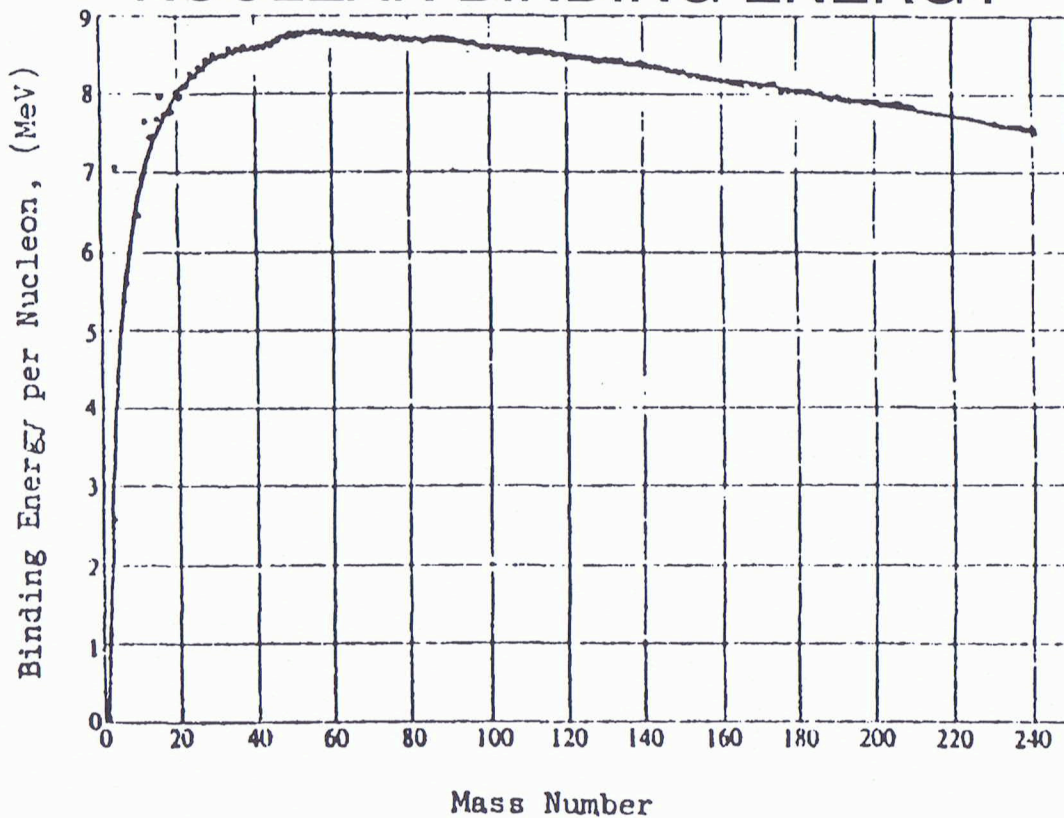

~~SECRET~~

UNCLASSIFIED

UNCLASSIFIED

~~SECRET~~

## Potential Fusion Reactions

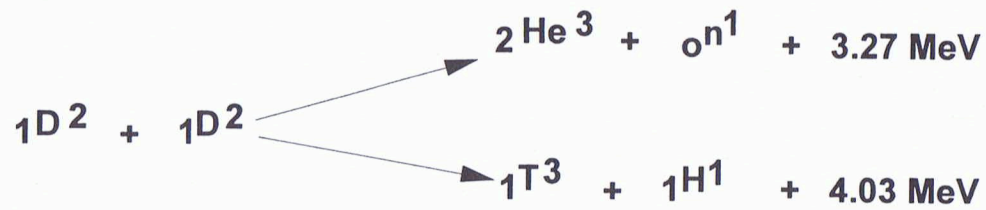

~~SECRET~~

UNCLASSIFIED

UNCLASSIFIED

~~SECRET~~

## Theoretical Fusion Energy in Equal Atom Mixture of Li<sup>6</sup>D

$$1 \text{ kg of Li}^6 \text{ has } \frac{6.025 \times 10^{26}}{6.0151} = 1.00165 \times 10^{26} \text{ Atoms}$$

$$1 \text{ kg of D has } \frac{6.025 \times 10^{26}}{2.0141} = 2.99141 \times 10^{26} \text{ Atoms}$$

Hence,

$$.25084 \text{ kg of D has } \left( \frac{2.01410}{6.01512 + 2.0141} \right) (2.99141 \times 10^{26}) \cong .75038410^{26} \text{ Atoms}$$

$$.7491 \text{ kg of Li}^6 \text{ has } \left( \frac{6.01512}{6.01512 + 2.0141} \right) (1.00165 \times 10^{26}) \cong .750390 \times 10^{26} \text{ Atoms}$$

$$\text{Li}^6 + {}_0\text{n}^1 \Rightarrow (.75039 \times 10^{26}) (4.6) \text{ MeV} \cong 13.2 \text{ kT}$$

$$\text{D} + \text{T} (.75039 \times 10^{26}) (17.6 \text{ MeV}) \cong 50.5 \text{ kT}$$

~~SECRET~~

UNCLASSIFIED

UNCLASSIFIED

~~SECRET~~

# TEMPERATURE EXPRESSED IN KT (ENERGY)

where K is Boltzmann Constant



$$1.38 \times 10^{-16} \text{ erg/}^\circ\text{K}$$

$$8.62 \times 10^{-8} \text{ keV/}^\circ\text{K}$$

$$T \text{ (in keV)} = 8.62 \times 10^{-8} T \text{ (in }^\circ\text{Kelvin)}$$

$$\text{Temperature of 1 keV} = 1.16 \times 10^7 \text{ degrees Kelvin}$$

~~SECRET~~

UNCLASSIFIED

UNCLASSIFIED

~~SECRET~~

# Rational for Choice of Fusion Reaction

~~SECRET~~

UNCLASSIFIED

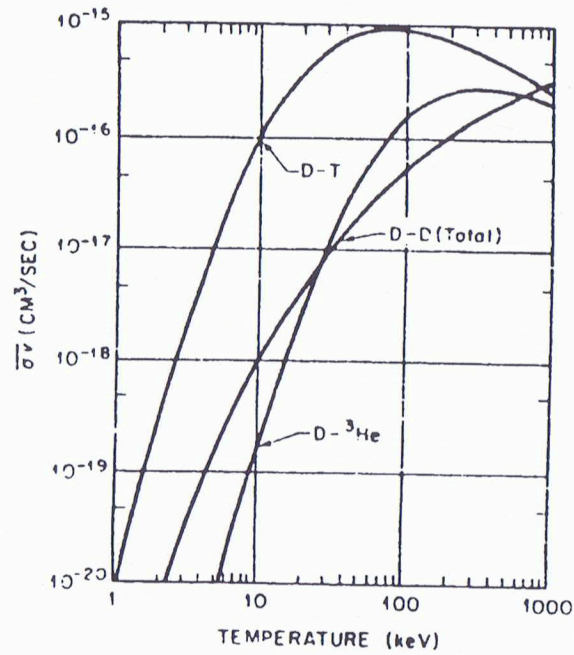
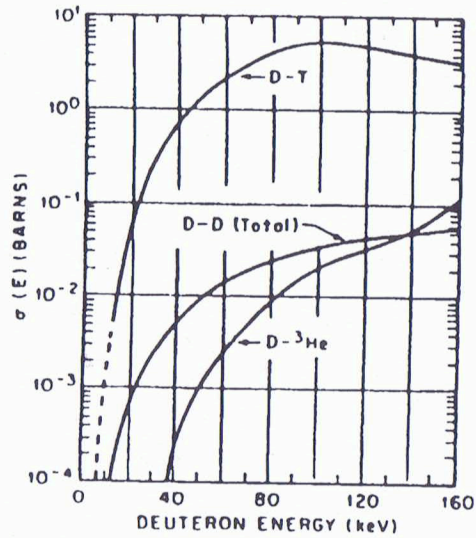

UNCLASSIFIED

~~SECRET~~

## *FUEL*

---

- ${}^6\text{LiD}$  (95%  ${}^6\text{Li}$ , 5%  ${}^7\text{Li}$ )

- Tritium



- Fusion



- Net Reaction



**Net Energy = 22.3 McV per Event**

~~SECRET~~

UNCLASSIFIED

UNCLASSIFIED

~~SECRET~~

~~SECRET~~

UNCLASSIFIED

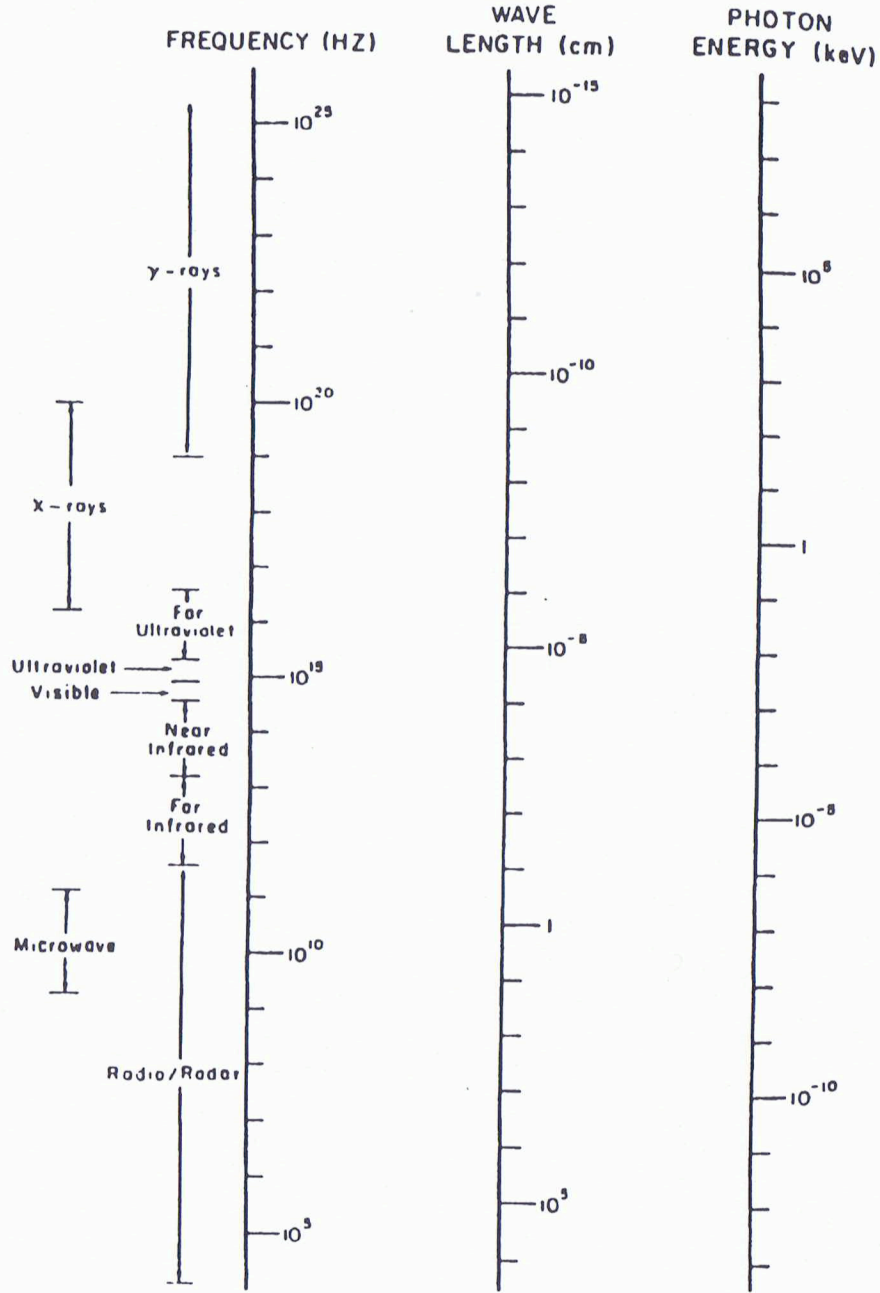

UNCLASSIFIED

~~SECRET~~



# Thermal Nuclear Plasma

AT FUSION TEMPERATURES, WE HAVE A PLASMA OF IONS (NUCLEI AND ELECTRONS).

$$\text{ENERGY} = aT_{(\text{ion})} + bT_{(\text{electron})} + cT_{(\text{radiation})}^4$$

---

IF PLASMA IS IN THERMODYNAMIC EQUILIBRIUM  
THE THREE TEMPERATURES ARE EQUAL  $\blacktriangleright$  AT HIGH  
TEMPERATURES, RADIATION WILL DOMINATE.

~~SECRET~~

UNCLASSIFIED

UNCLASSIFIED

~~SECRET~~

## REFERENCES

AN INTRODUCTION TO NUCLEAR WEAPONS; WASH 1037 REVISED; SRD (n) SIGMA 1 etc.; GLASSSTONE AND REDMAN.

SOURCE BOOK ON ATOMIC ENERGY; GLASSSTONE; UNC 3<sup>rd</sup> EDITION

BASIC NUCLEAR PHYSICS; INTERSERVICE NUCLEAR WEAPONS SCHOOL

DNA PUBLICATIONS – TECHNOLOGY ANALYSIS REPORT

SANDIA, LLL, LANL TECHNOLOGY REPORTS

UNCLASSIFIED

~~SECRET~~

UNCLASSIFIED

~~SECRET~~

# SURVEY OF WEAPONS DEVELOPMENT AND TECHNOLOGY

WR708

~~SECRET~~

UNCLASSIFIED

SESSION III

• NUCLEAR EFFECTS

UNCLASSIFIED

~~SECRET~~

## CONVENTIONAL EXPLOSIVE

RELEASE OF ENERGY ARISES FROM THE  
BREAKING OF CHEMICAL BONDS (ELECTRON  
BONDS) IN THE HIGH EXPLOSIVE MATERIAL

## NUCLEAR EXPLOSIVE

RELEASE OF ENERGY ARISES FROM THE  
BREAKING OR MAKING OF NUCLEAR BONDS  
(HADRON-HADRON)

FISSION AND FUSION YIELDS ENERGY RELEASE +  
PARTICLES

~~SECRET~~  
UNCLASSIFIED

UNCLASSIFIED

~~SECRET~~

# Effects of a Nuclear Explosion

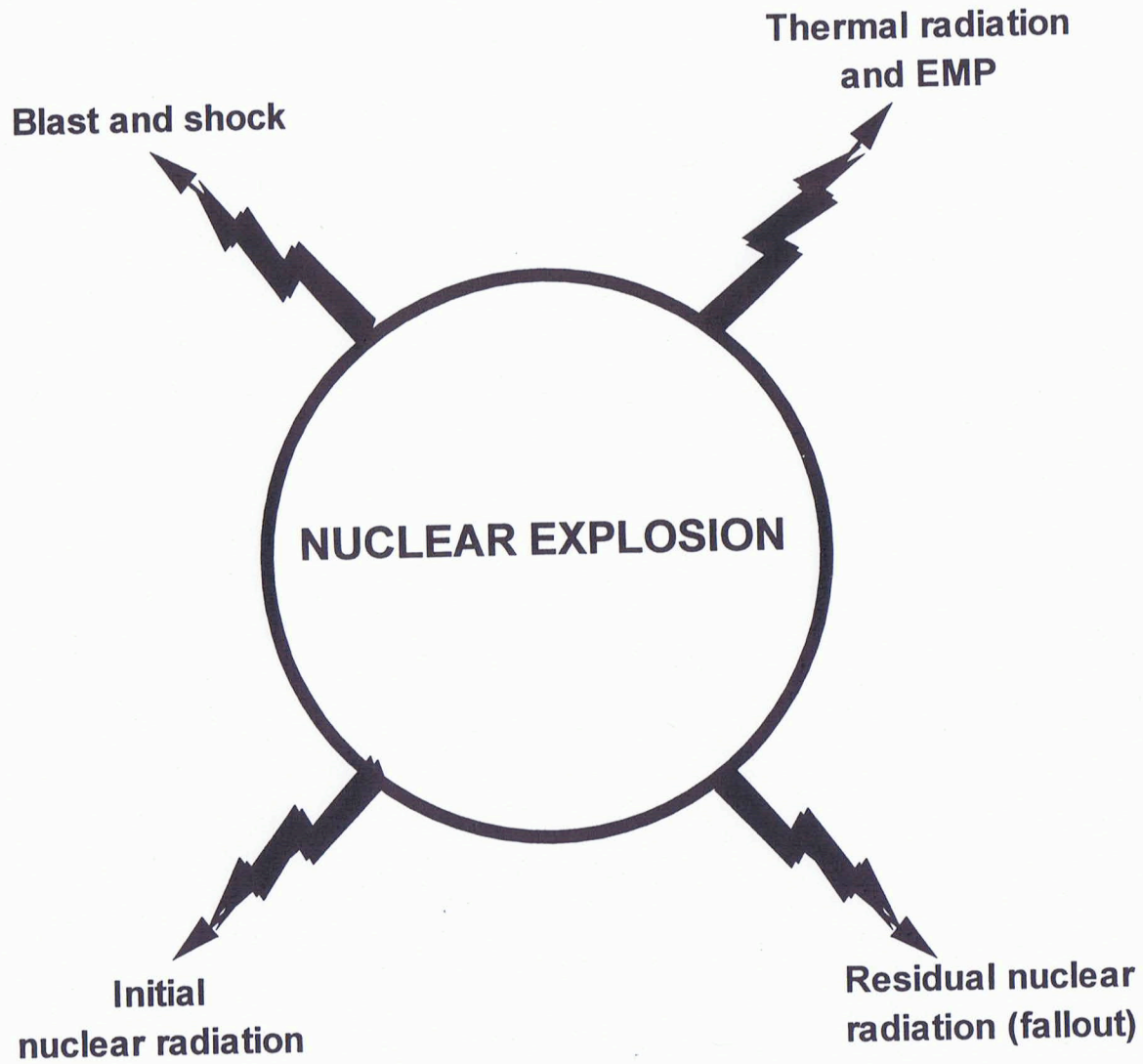

~~SECRET~~

UNCLASSIFIED

UNCLASSIFIED

~~SECRET~~

# Nuclear Effects Generalities

---

## Subject Generally Divided into 3 areas

- Phenomenology
  - Physics at the weapons source
- Interaction of the nuclear
- Military effects
  - Smashing (over pressure)
  - Turning over (dynamic - winds)
  - Fires (Thermal pulse)
  - Radiation
  - Craters

~~SECRET~~

UNCLASSIFIED

UNCLASSIFIED

~~SECRET~~

## What are Nuclear Effects Calculations Used For?

---

- Determine how "hard" (radiation, blast, etc.) to make the weapon system (major cost implication)
  - Determine the proper yield/accuracy combination
  - Placement of weapon system on the battlefield
  - Targeting
  - Number of nuclear weapons required to achieve an objective
  - Safety zones
  - Etc.
- 
- Historically, this is an area that has caused much discussion and argument. However, over the years, DNA has developed tools to standardize the methodology and has contributed greatly to the understanding of this area.
    - Textbooks
    - Nomograms/Slide Rules
    - T159 - Programs
    - HP 41 CX - Programs
    - Personal Computer Software

~~SECRET~~

UNCLASSIFIED

UNCLASSIFIED

~~SECRET~~

# NUCLEAR SEPARATION DISTANCE

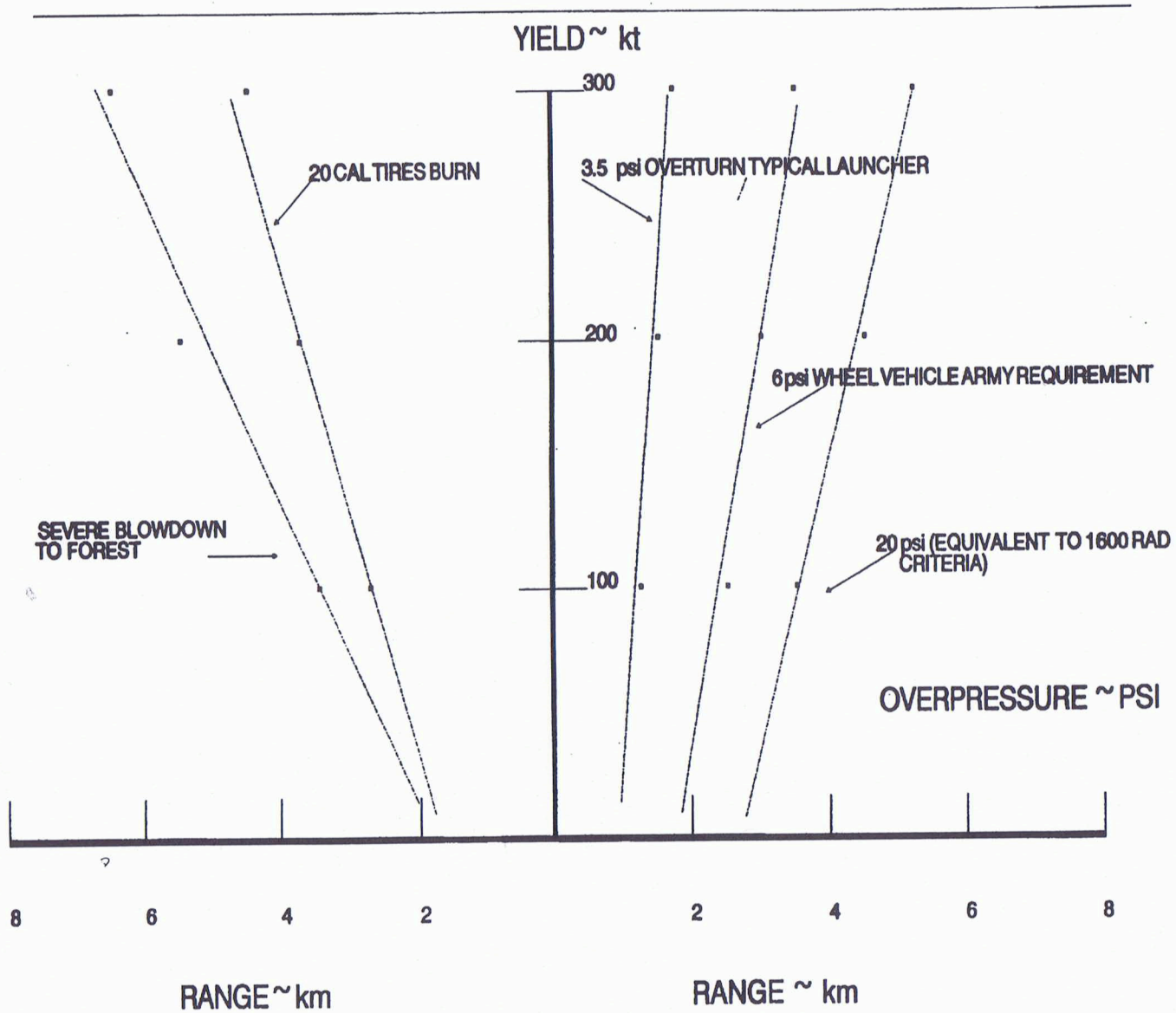

SECRET

UNCLASSIFIED

UNCLASSIFIED

SECRET



~~SECRET~~

UNCLASSIFIED

CONVENTIONAL WEAPON



NUCLEAR WEAPON

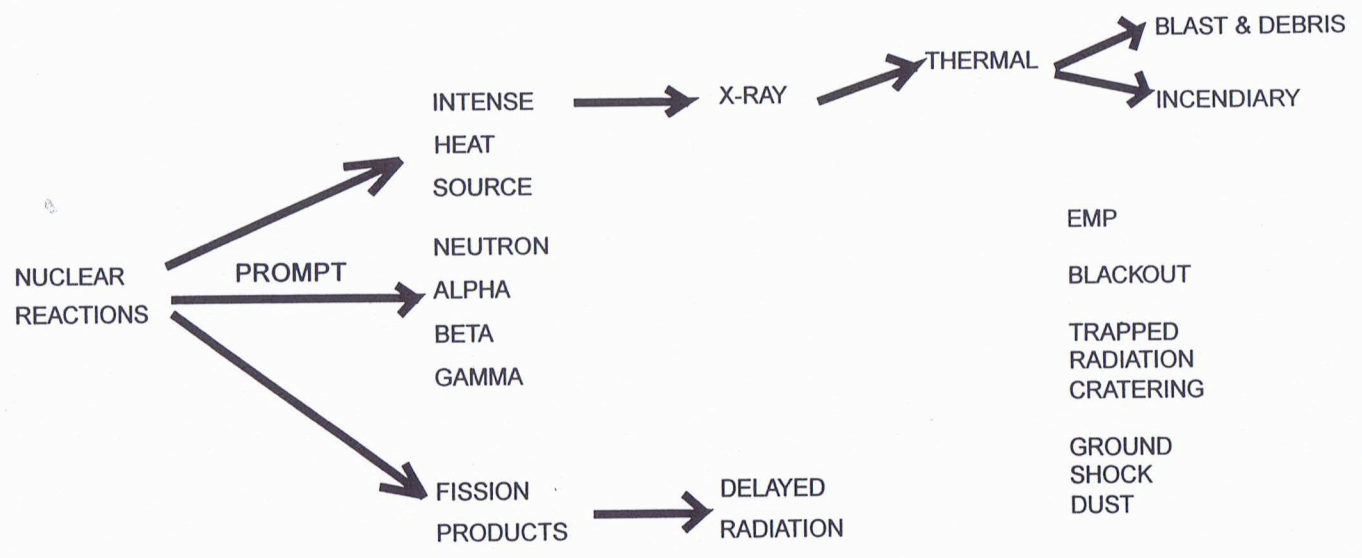

UNCLASSIFIED

~~SECRET~~

# Nuclear Effects

DIRECT  
WEAPON  
OUTPUT

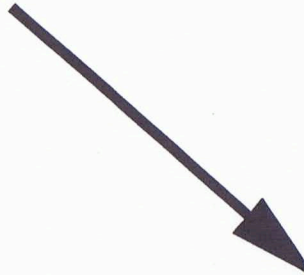

TRANSMISSION  
THROUGH  
SOME  
MEDIA

"NEW PHENOMENA"  
MAY BE GENERATED  
AS IT GOES THROUGH  
A MEDIA



PHENOMENOLOGY AT  
THE TARGET



SYSTEM  
INTERACTIONS

~~SECRET~~

UNCLASSIFIED

UNCLASSIFIED

~~SECRET~~

# THE NUCLEAR PHENOMENOLOGY EXPERIENCED BY A SYSTEM DEPENDS ON:

- YIELD OF WEAPON
- DESIGN OF WEAPON
- WHERE WEAPON WAS DETONATED
- WHERE SYSTEM IS
- FOR SOME EFFECTS, WHAT SYSTEM IS DOING

~~SECRET~~

UNCLASSIFIED

UNCLASSIFIED

~~SECRET~~

**NEUTRONS COME DIRECTLY FROM****Fission**

**N + fissionable material → two or more fission fragments  
+ neutrons + energy**

**And**

**Fusion**

**D + T → He<sup>4</sup> + neutron + energy**

**T + T → He<sup>4</sup> + 2 neutrons + energy**

**D + D → He<sup>3</sup> + neutron + energy**

~~SECRET~~

UNCLASSIFIED

UNCLASSIFIED

~~SECRET~~

# Fission Neutron Energy Spectrum

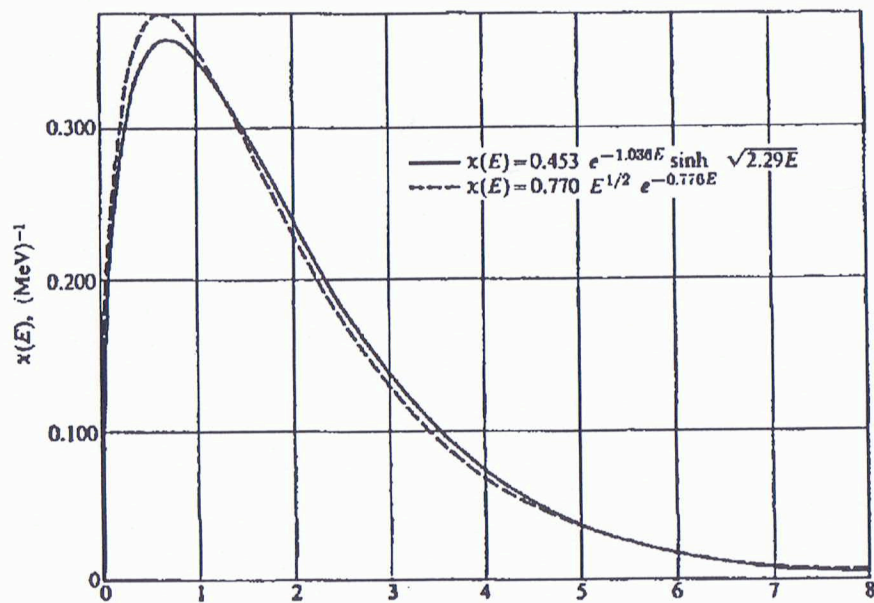

Neutron Energy (MeV)

Reference: Lamarsh, 1966

~~SECRET~~

UNCLASSIFIED

UNCLASSIFIED

~~SECRET~~

# Neutron Spectra

~~SECRET~~

UNCLASSIFIED

UNCLASSIFIED

~~SECRET~~

~~SECRET~~

UNCLASSIFIED

Doc  
b(3)

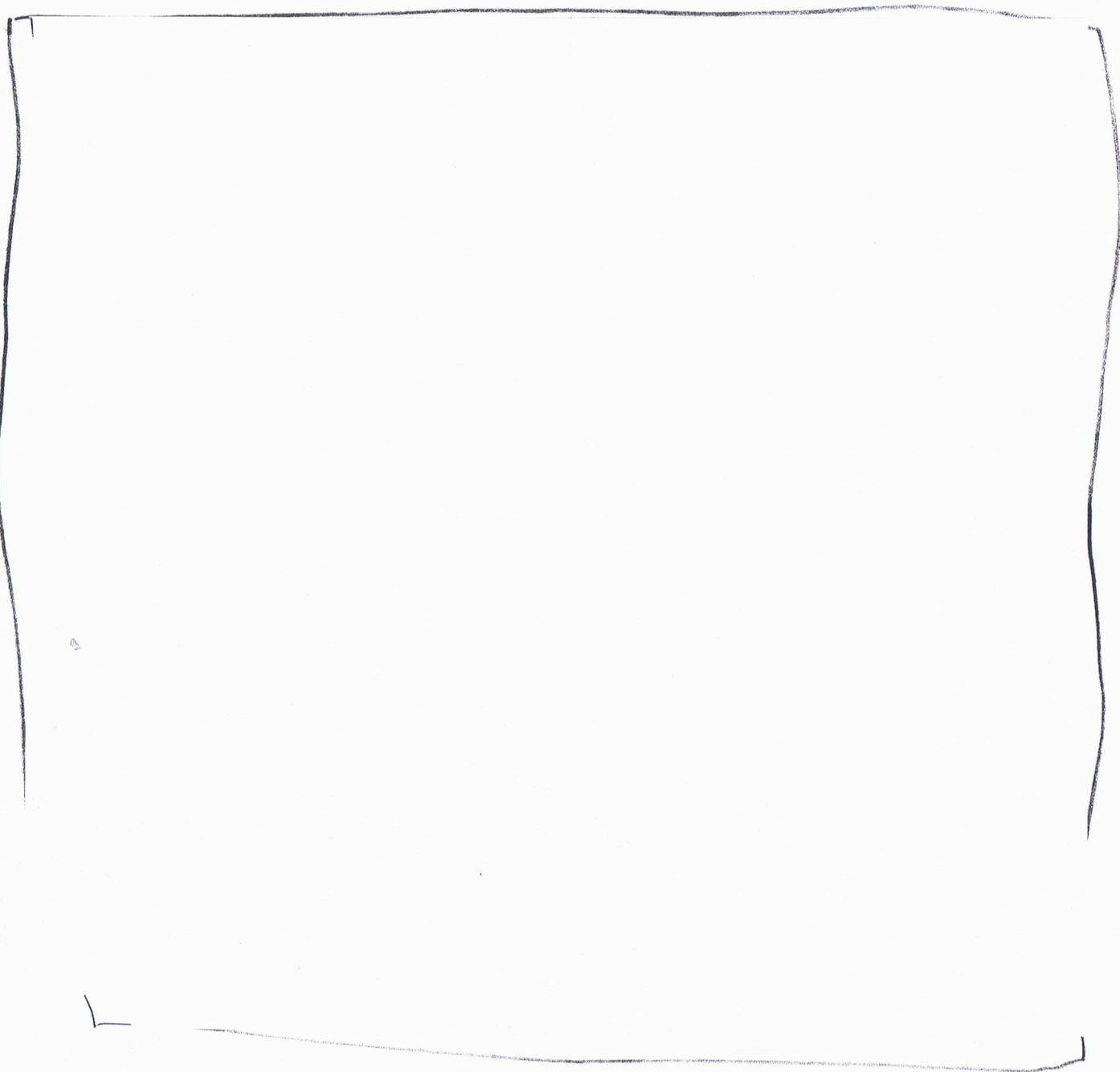

UNCLASSIFIED

~~SECRET~~

B-3

UNCLASSIFIED

~~SECRET~~

~~SECRET~~  
UNCLASSIFIED



~~SECRET~~

UNCLASSIFIED

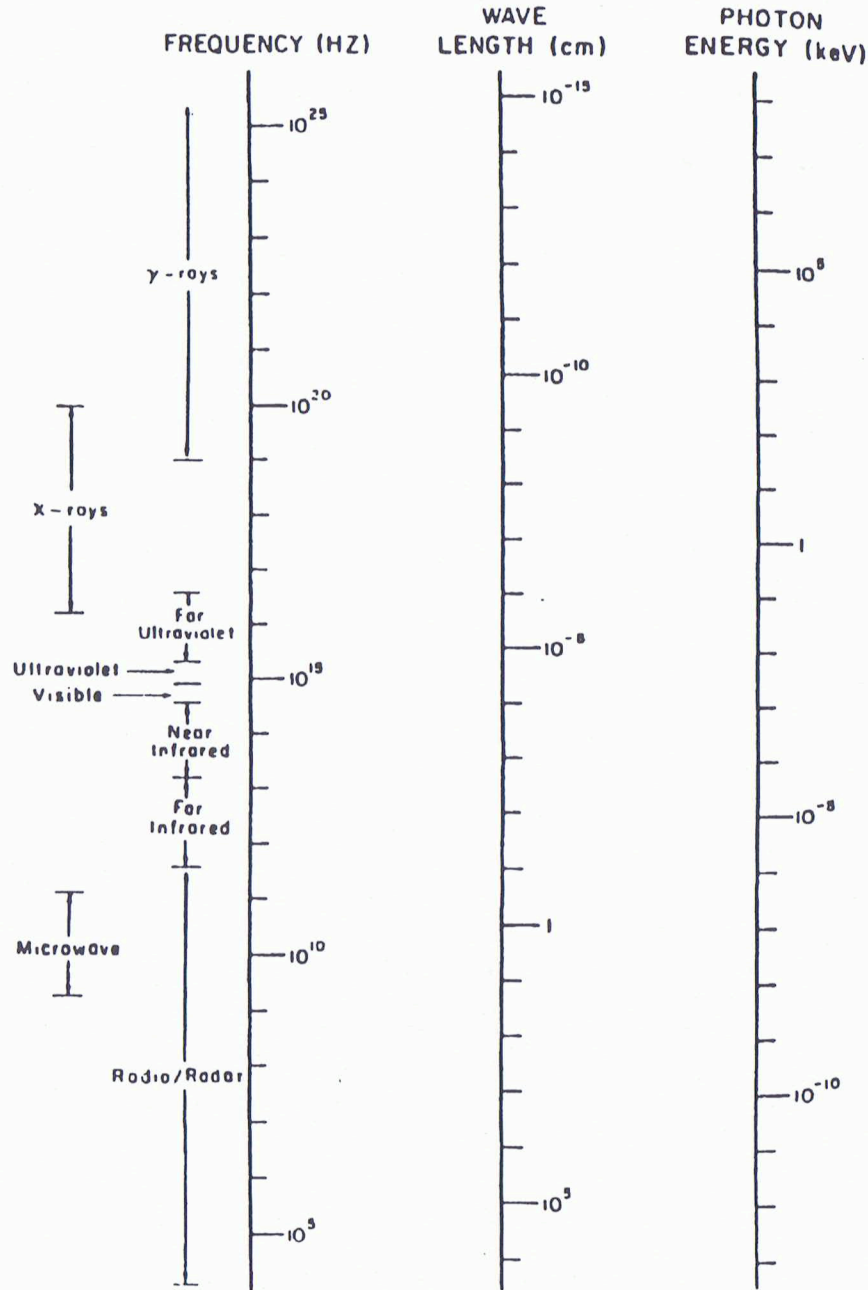

UNCLASSIFIED

~~SECRET~~

B-3



DOE

(b)(3)

~~SECRET~~

UNCLASSIFIED

UNCLASSIFIED

~~SECRET~~

# GAMMA RAYS

## ELECTROMAGNETIC RADIATION

### SOURCE:

- DETONATION FISSIONS

### EARLY

- NEUTRON INELASTIC SCATTER IN WEAPON DEBRIS
- NEUTRON INELASTIC SCATTER IN THE AIR AND GROUND

### LATER

- CAPTURE OF SLOW NEUTRONS BY NITROGEN
- FISSION PRODUCT DECAY

~~SECRET~~

UNCLASSIFIED

~~SECRET~~

UNCLASSIFIED

~~SECRET~~

UNCLASSIFIED

DOE  
b(2)

~~SECRET~~

UNCLASSIFIED

# BLAST AND THERMAL

IT'S HOT, HOT,-----  
SO IT RADIATES HEAT

THERE'S HIGH, HIGH, HIGH PRESSURE-----  
SO IT TRANSMITS A PRESSURE PULSE

~~SECRET~~

UNCLASSIFIED

~~SECRET~~

UNCLASSIFIED

## SEQUENCE OF EVENTS AFTER A NUCLEAR DETONATION IN THE ATMOSPHERE

1. ONCE UPON A TIME THERE WAS A NUCLEAR WEAPON--NOW THERE'S THIS 10 MILLION PLUS DEGREE BLOB OF VAPORIZED MATERIAL OCCUPYING ROUGHLY THE SAME VOLUME (78% OF ENERGY IS IN X-RAY).

2. THIS VOLUME RADIATES ELECTROMAGNETIC ENERGY IN THE X-RAY SPECTRUM.

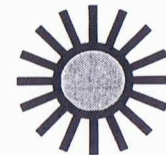

~~SECRET~~

UNCLASSIFIED

~~SECRET~~  
UNCLASSIFIED

3. THE MEAN FREEPATH OF "X-RAYS" IS .3 cm AT SEALEVEL. THE SURROUNDING LAYER OF AIR IS SUPERHEATED. INITIAL X-RAY FIREBALL

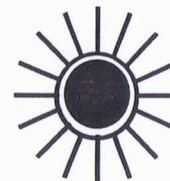

4. THIS ABSORPTION AND RERADIATING PROCESS RESULTS IN A RAPIDLY EXPANDING RADIATION FIREBALL. RADIATION GROWTH PHASE.

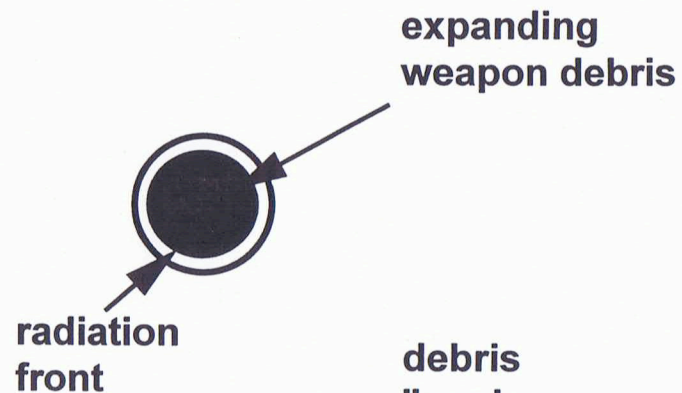

5. THE WEAPON DEBRIS SNOWPLOWS AIR AND A "NUCLEAR SHOCK" IS FORMED. RADIATION FIREBALL CONTINUES TO GROW, BUT GROWTH SLOWS BECAUSE COOLING REDUCES MFP.

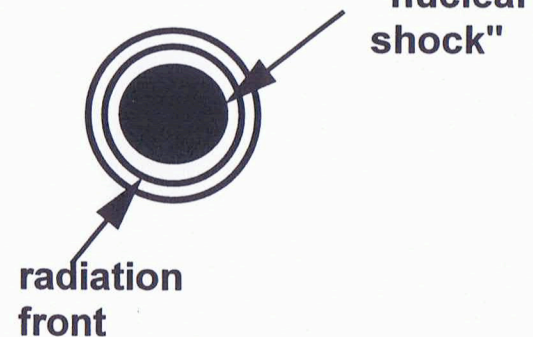

~~SECRET~~

UNCLASSIFIED

UNCLASSIFIED

~~SECRET~~

DoP  
H(3)

6. SHOCKWAVE ASSOCIATED WITH THE FRONT BECOMES DOMINANT. NUCLEAR SHOCK STARTS TO "CATCH-UP." HYDRODYNAMIC SEPARATION

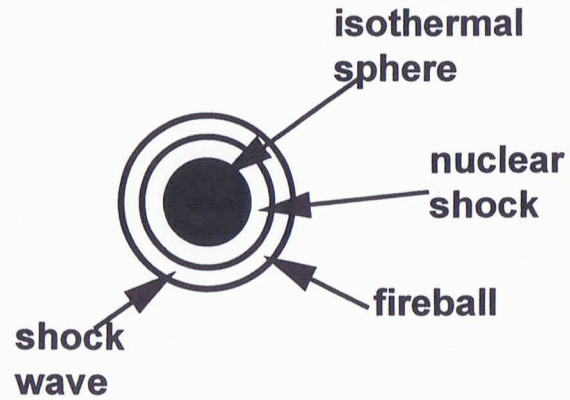

7. NUCLEAR SHOCK CATCHES UP, BUT REINFORCED SHOCKWAVE COOLS TO 3,000 DEGREES CELSIUS AND STARTS TO BECOME TRANSPARENT. SHOCK BREAKAWAY.

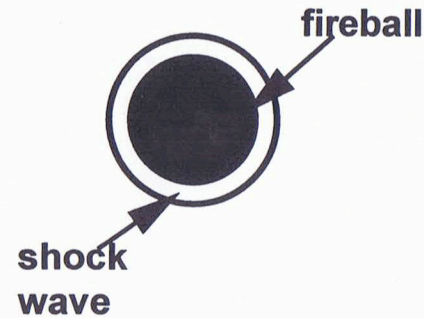

8. NO FURTHER INTERACTION BETWEEN EXPANDING SHOCKWAVE AND FIREBALL.



~~SECRET~~  
UNCLASSIFIED

UNCLASSIFIED

~~SECRET~~



# THERMAL Observed Thermal Pulse

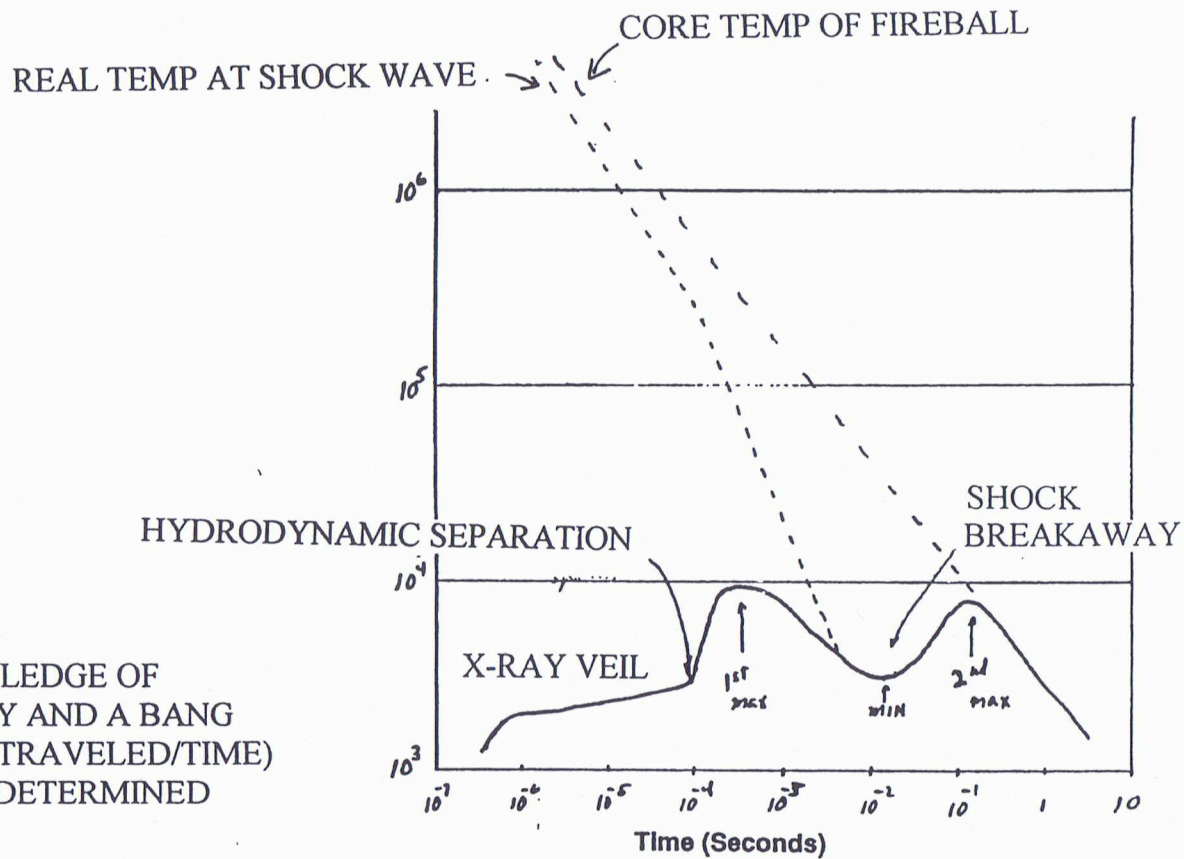

USE: FROM A KNOWLEDGE OF SHOCK BREAKAWAY AND A BANG METER (DISTANCE TRAVELED/TIME) THE YIELD CAN BE DETERMINED

SECRET

UNCLASSIFIED

SECRET

UNCLASSIFIED

BLAST

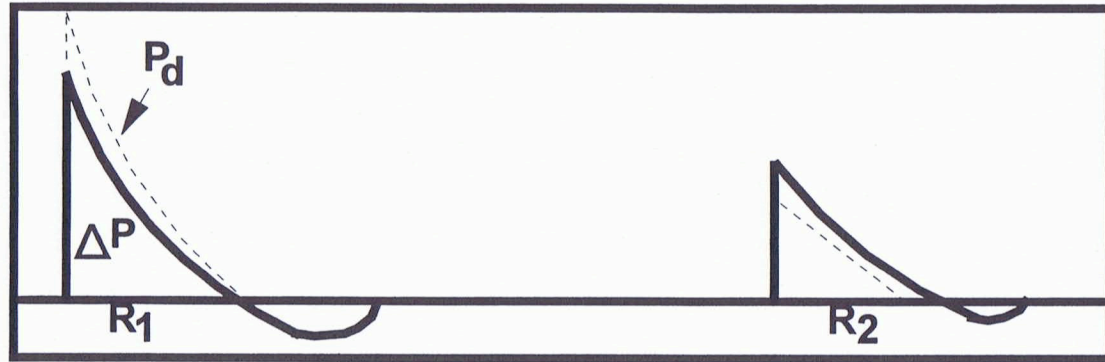

$R_2 > R_1$

OVERPRESSURE  
DYNAMIC (GUST)  
TIME DEPENDENCE

$$\Delta P = P - P_0$$

$$P_d = 1/2 MV^2$$

$$P_d > \Delta P \quad (\Delta P > 100 \text{ PSI})$$

$$P_d < \Delta P \quad (\Delta P < 100 \text{ PSI})$$

UNCLASSIFIED

~~SECRET~~

UNCLASSIFIED

~~SECRET~~

## AWAY FROM SOURCE AIRBLAST

SCALABLE PHENOMENA — SACH'S SCALING  $\left[ \frac{D_1}{D_0} \right] = \left[ \frac{W_1}{W_0} \right]^{1/3}$

BASIS IS COMPLETE DATA FOR 1 CASE EX: 1 kT STANDARD

FOR ALTITUDES OTHER THAN SEA LEVEL  $\left[ \frac{D_1}{D_0} \right] = \left[ \frac{W_1}{W_0} \right]^{1/3} \left[ \frac{P_0}{P} \right]^{1/3}$

OTHER IMPORTANT ASPECTS:

MACHSTEM AND TRIPLE POINT PATH  
OPTIMAL HOB FOR MAXIMIZING OVERPRESSURE  
PRECURSOR

WILL BE COVERED LATER AND IN THE EFFECTS MOVIE

~~SECRET~~

UNCLASSIFIED

UNCLASSIFIED

~~SECRET~~

~~SECRET~~

UNCLASSIFIED

⊙ = Data from AFWL - TR 73-75

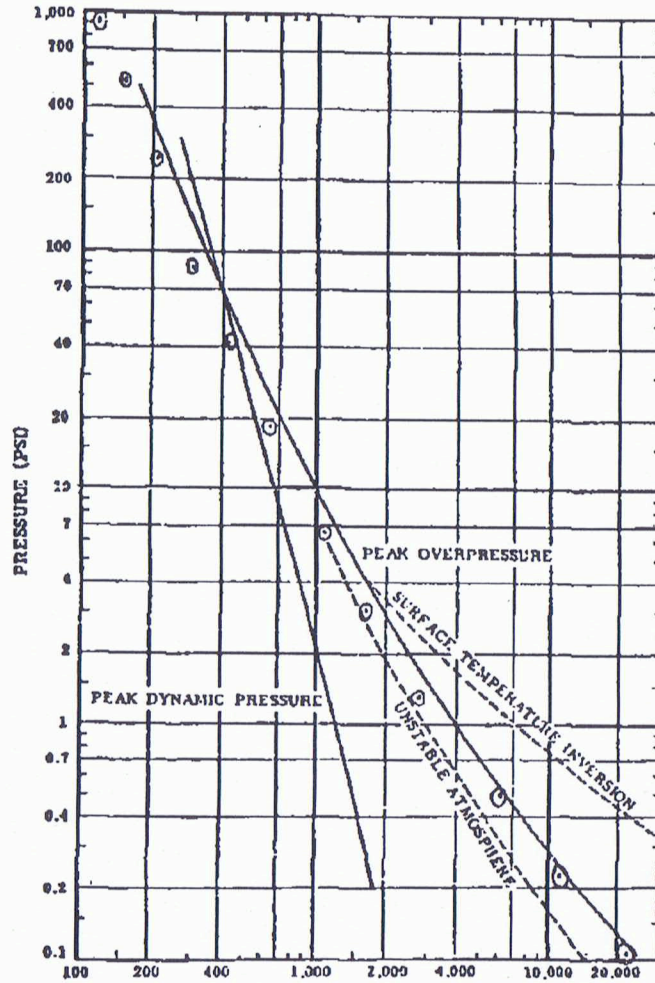

Distance from Ground Zero (feet)  
1 Kiloton Standard (from Glasstone)

UNCLASSIFIED

~~SECRET~~

~~SECRET~~

UNCLASSIFIED

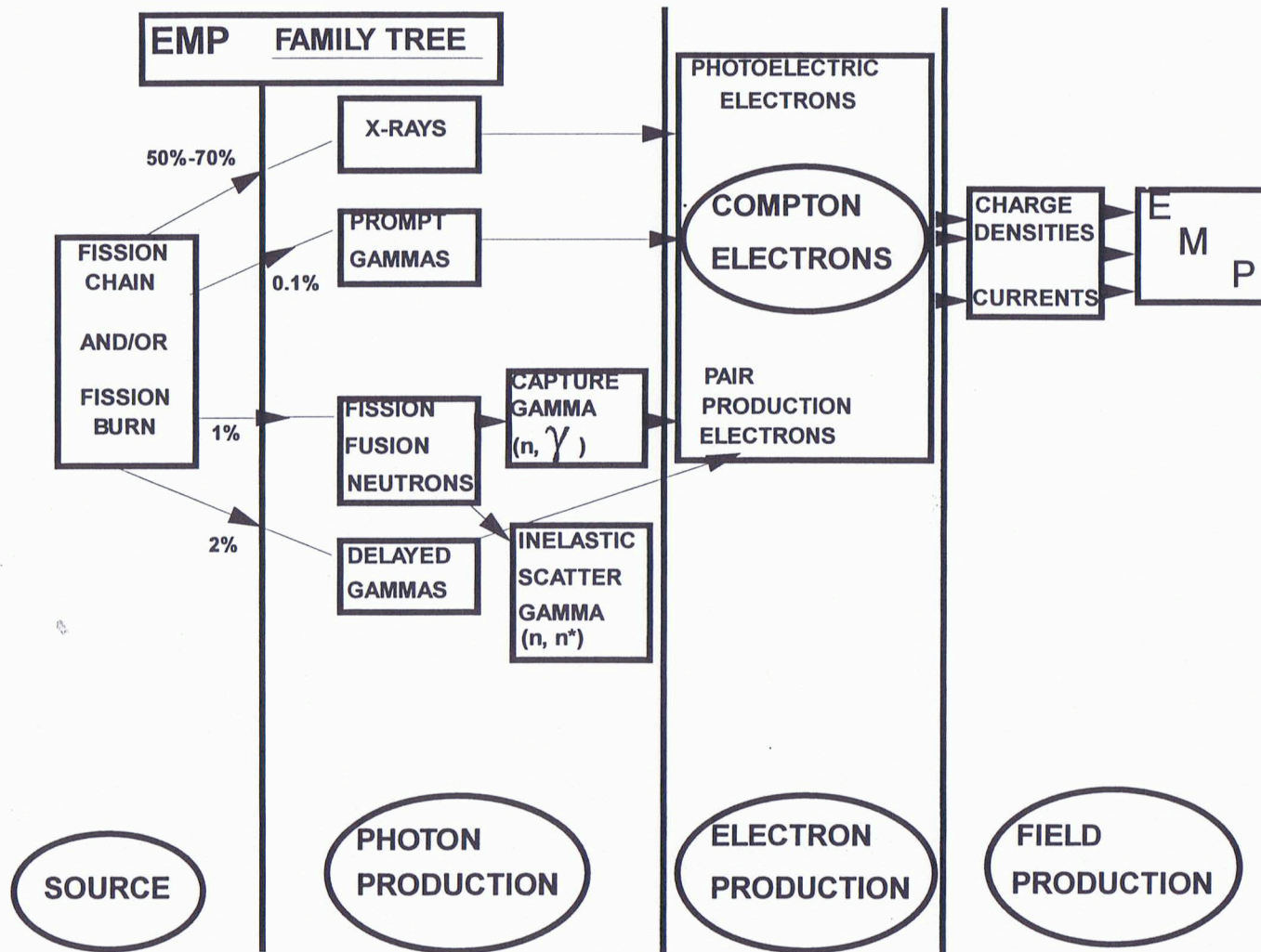

Bottom Line: electron moves in assymmetric field

UNCLASSIFIED

~~SECRET~~

# High Altitude EMP

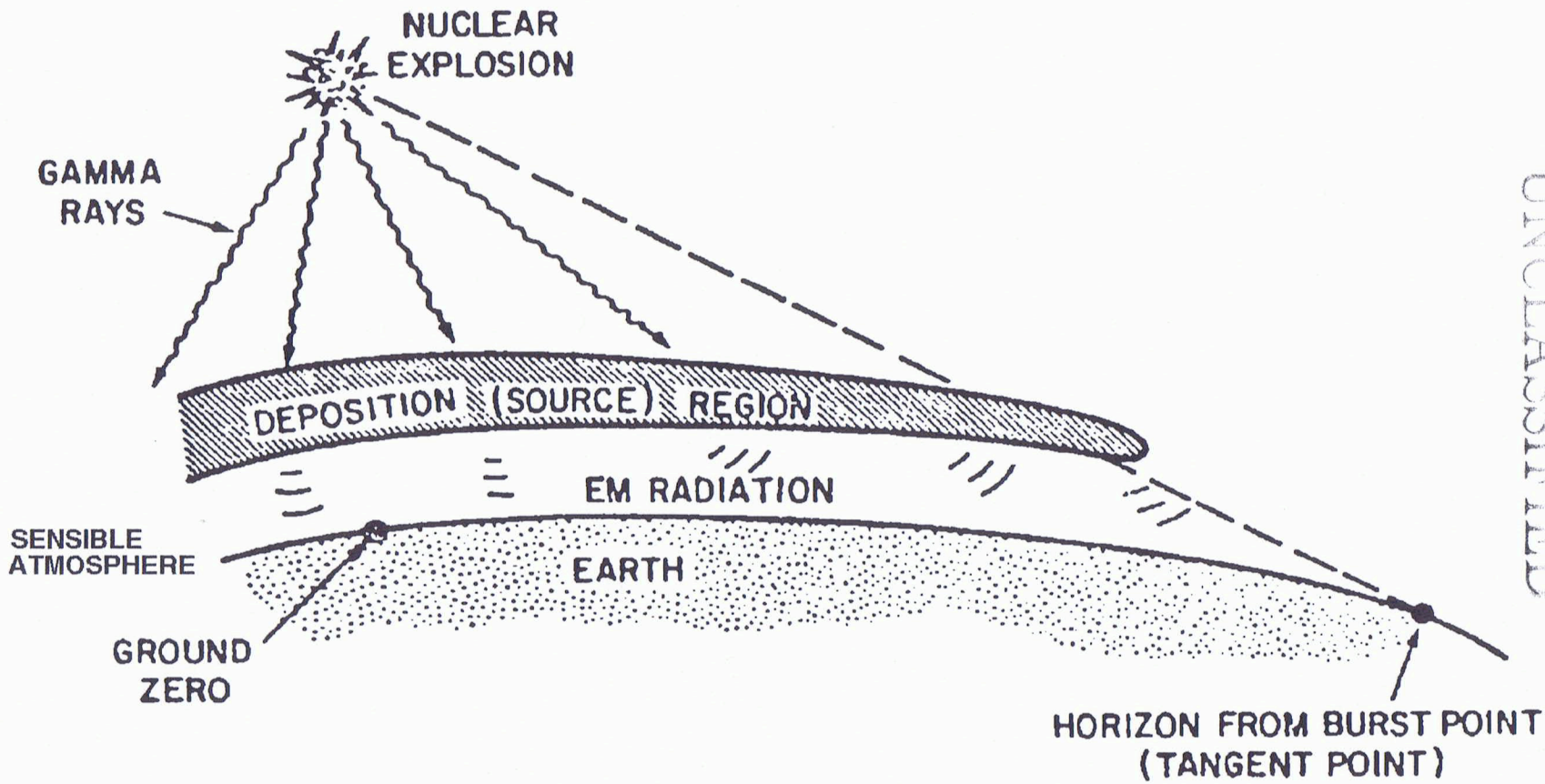

~~SECRET~~

UNCLASSIFIED

UNCLASSIFIED

~~SECRET~~

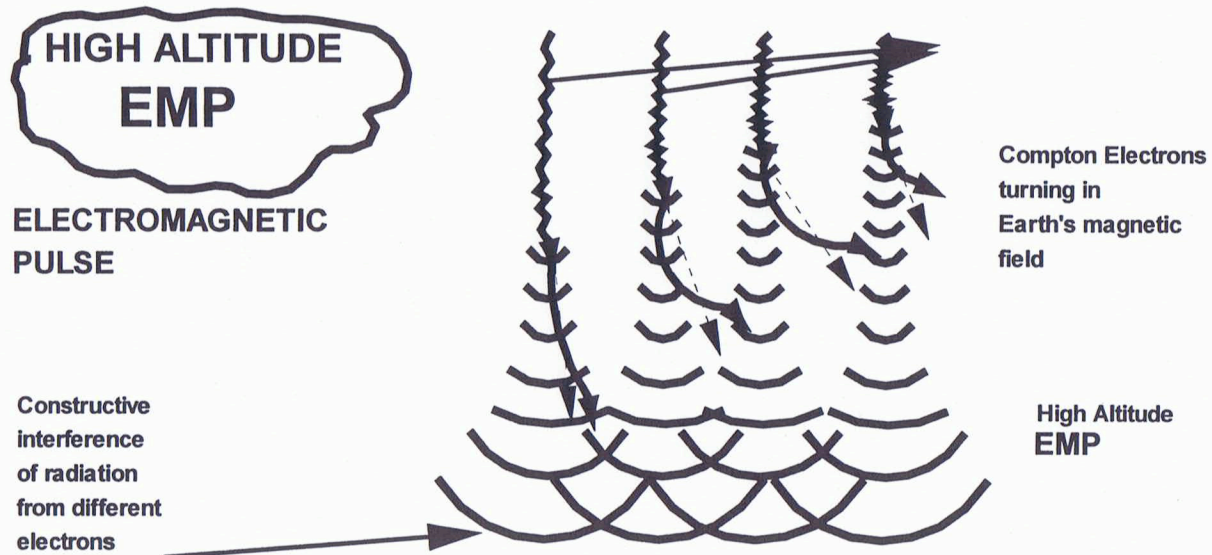

**KEY Points**

1. Each  $\gamma$  gives a downward traveling compton electron.
2. The electrons are turned by the earth's magnetic field.
3. The relativistic electrons radiate energy downward.
4. The  $\gamma$  's and EMP radiation travel at the same speed.  
This leads to constructive interference of radiation from all electrons.

# EMP PULSE

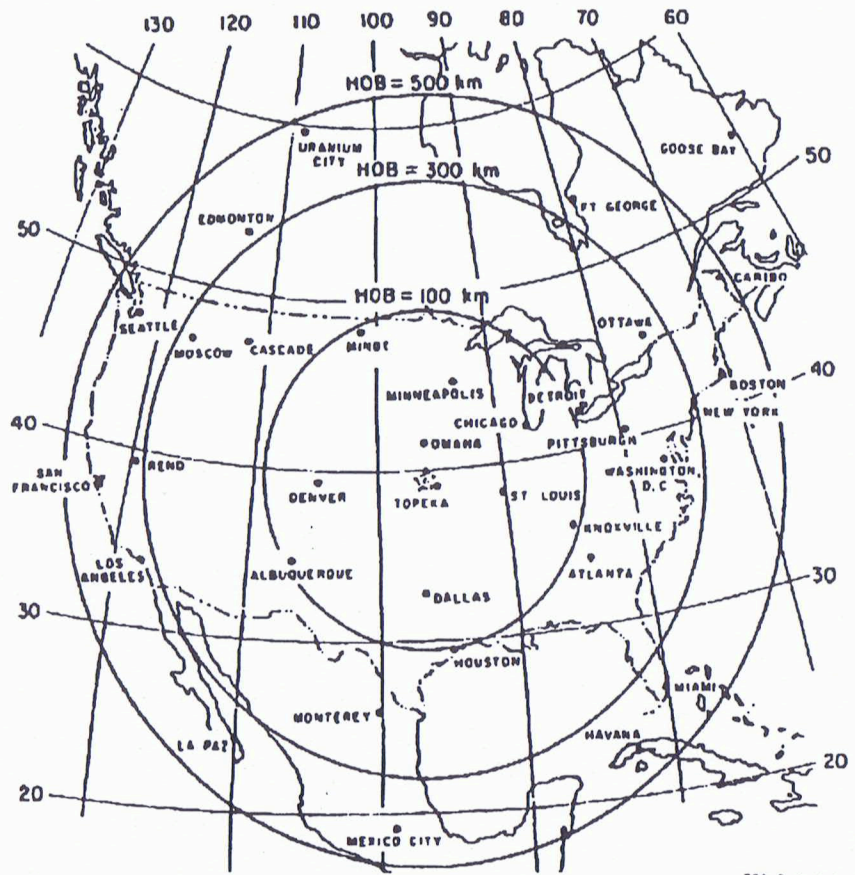

Ground Coverage for Bursts of 100, 300, and 500 km (about 62, 186, and 310 miles) for a Large Yield Burst Above the Geographical Center of the (counterterminous) United States

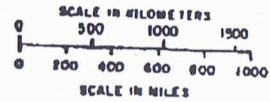

~~SECRET~~

UNCLASSIFIED

UNCLASSIFIED

~~SECRET~~



# Frequency Spectrum Comparison

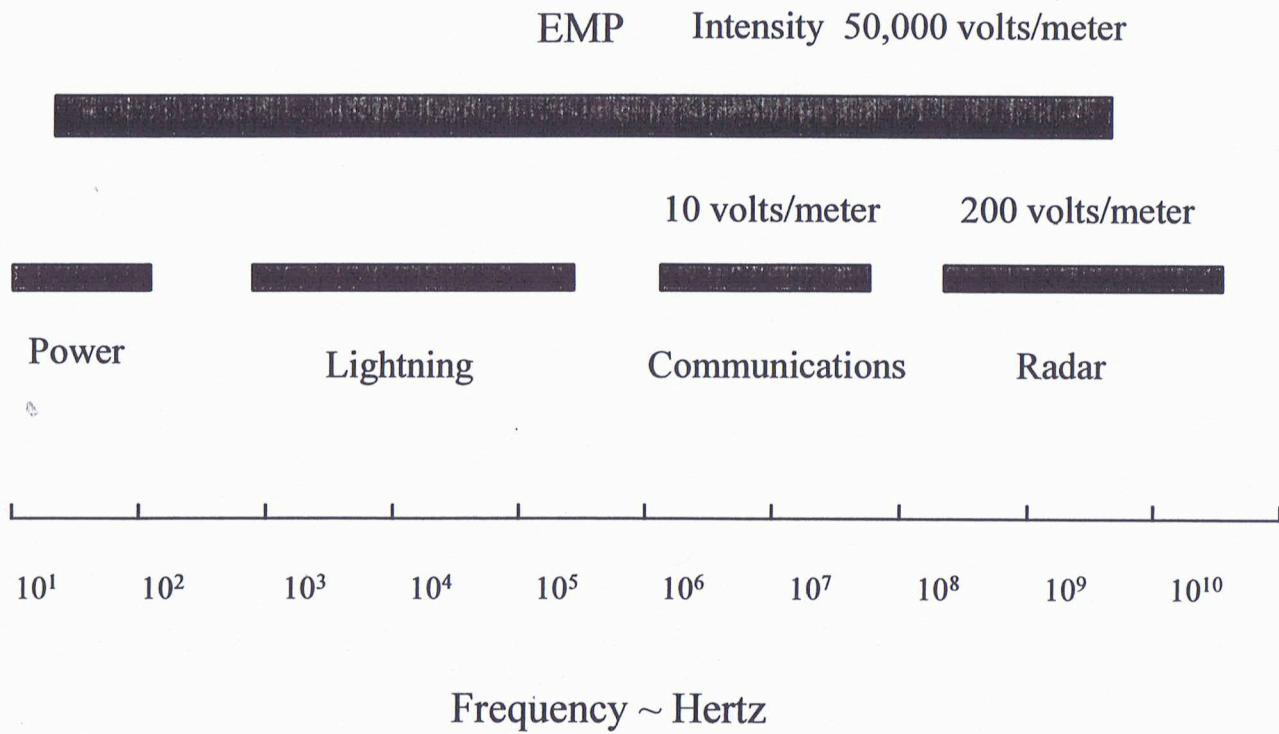

UNCLASSIFIED

UNCLASSIFIED

SECRET

SECRET

# Representative EMP Pulse

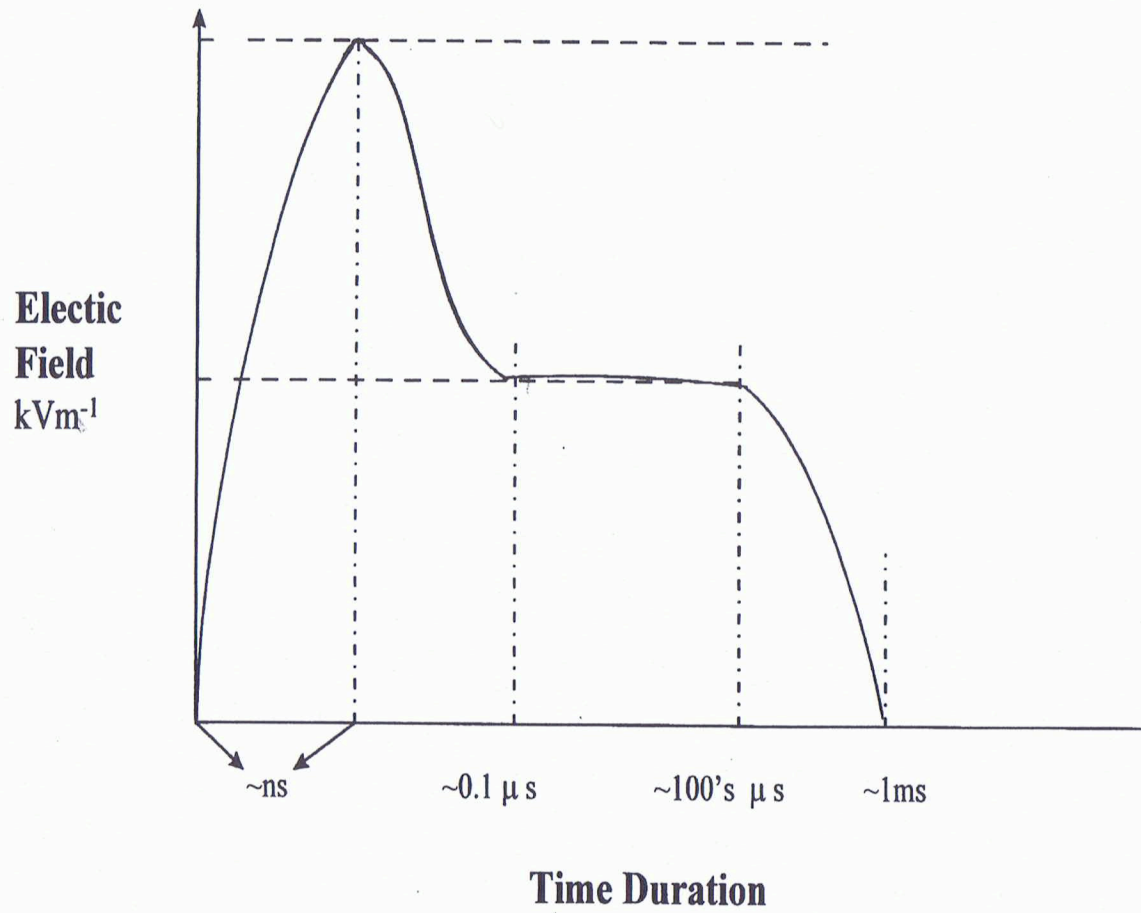

~~SECRET~~

UNCLASSIFIED

UNCLASSIFIED

~~SECRET~~

MILITARY EFFECTIVENESS  
(TANKS)

COLLATERAL DAMAGE  
(EXPOSED PERSONNEL)

\*  
10 KT FISSION

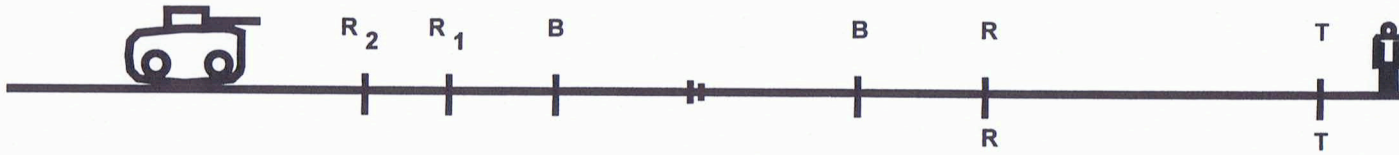

\*  
1 KT FISSION



\*  
1 KT ER



~~SECRET~~

UNCLASSIFIED

UNCLASSIFIED

~~SECRET~~

## 1 MT DETONATIONS AT VARIOUS HOB's (CO-Altitude)

	N 10 <sup>12</sup> n/cm <sup>2</sup>	N 10 <sup>15</sup> n/cm <sup>2</sup>	γ 10 <sup>8</sup> rad/sec	γ 10 <sup>13</sup> rad/sec	X-ray 20 cal/cm <sup>2</sup>	X-ray 130 cal/cm <sup>2</sup>	Thermal 4 cal/cm <sup>2</sup>	Thermal 80 cal/cm <sup>2</sup>	Over 2 psi	Over 10 psi	Over 3000 psi
Exoatmospheric	157	5.6	760	2.4	56.8	22.2	-----	-----	-----	-----	-----
100,000 ft	12.5	5.5	190	2.3	10.4	6.0	98	22	8.5	4.6	.7
1,800 ft	6.2	2.5	9.0	1.3	-----	-----	49	19	29.5	10.8	.8
Surface	5.6	2.3	8.5	1.3	-----	-----	40.4	12.1	25	10	1.1

Distances to Effect Levels in kilo-feet

~~SECRET~~

UNCLASSIFIED

UNCLASSIFIED

~~SECRET~~

**SECRET**

UNCLASSIFIED

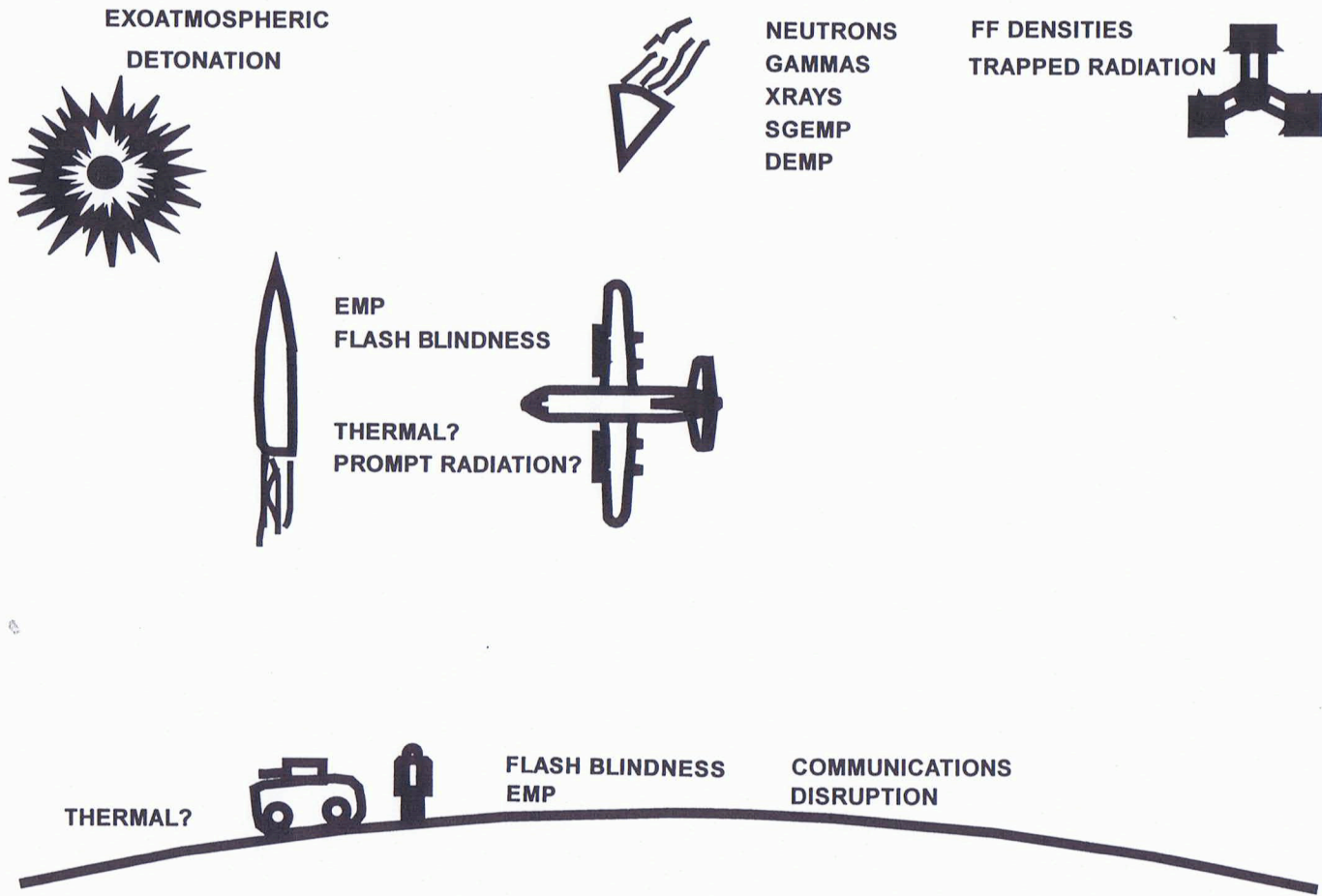

UNCLASSIFIED

**SECRET**

~~SECRET~~

UNCLASSIFIED

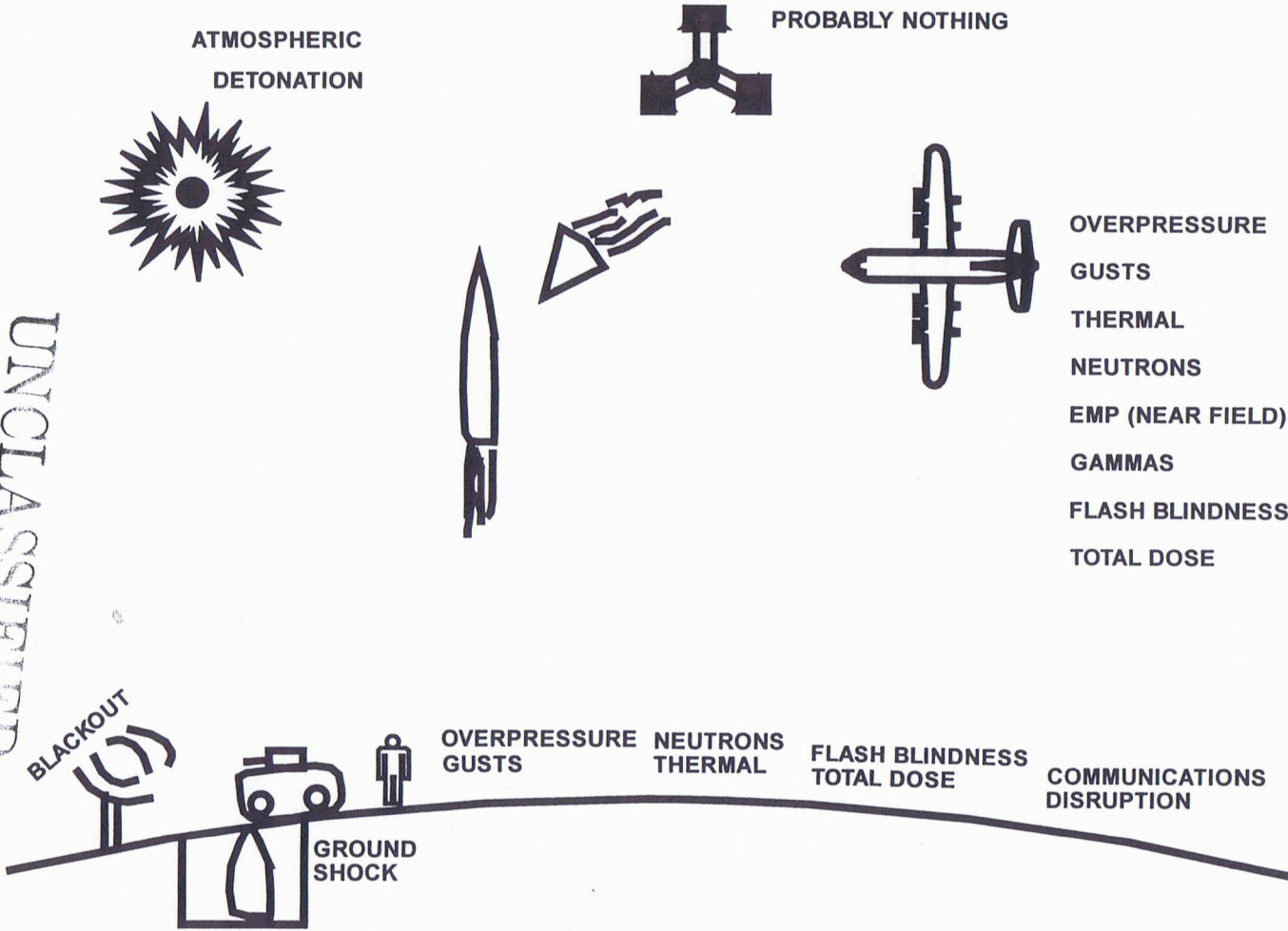

UNCLASSIFIED

~~SECRET~~

~~SECRET~~

UNCLASSIFIED



NOTHING

DUST?  
THERMAL?  
OVERPRESSURE?

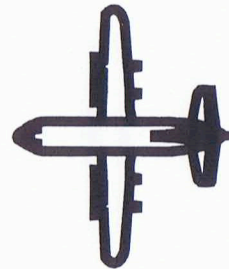

TOTAL DOSE

GROUND  
DETONATION

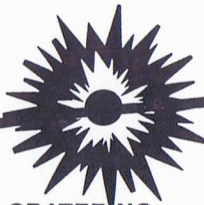

CRATERING



DISPLACEMENT  
EMP (NEAR FIELD)



OVERPRESSURE  
GUSTS  
THERMAL  
TOTAL DOSE  
(FALLOUT)

UNCLASSIFIED

~~SECRET~~

## Useful Rules-of-Thumb for Prompt Effects

---

- Emergency Risk
  - Thermal -- 3 cal/cm<sup>2</sup>
  - Blast -- 4 psi
- Casualty from Blast
  - Exposed personnel -- 18 psi
  - Severe Tank Damage -- 49 psi
- Radiation Dose
  - Casualty -- 8,000 rads
  - Emergency Risk -- 150 rads

~~SECRET~~

UNCLASSIFIED

UNCLASSIFIED

~~SECRET~~



## Radiation Dose Immediate Casualty -- 8,000 rads

Range	Yield	Adjustment factor
~0.5 km	~1 KT fission	~100m range for every factor 2 in yield
~1 km	~ 1 KT enhanced Radiation	~100m range for every factor 2 in yield
~1 km	~ 25 KT typical Fission	~100m range for every factor 2 in yield

~~SECRET~~

UNCLASSIFIED

UNCLASSIFIED

~~SECRET~~

## Radiation Dose-Prompt Effects

---

Casualty	8,000 rads	~0.5 km	1 KT fission
Casualty	8,000 rads	~ 1 km	1 KT ER
Casualty	8,000 rads	~ 1 km	25 KT fission
Emergency Risk	150 rads	~1.5 km	1 KT ER
Emergency Risk	150 rads	~1.5 km	25 KT fission

UNCLASSIFIED

~~SECRET~~

UNCLASSIFIED

~~SECRET~~

**SOME EFFECTS LEVELS OF INTEREST**

PEOPLE

THERMAL            2-5 CAL/CM2

OVERPRESSURE >7 PSI

RADIATION        >100 RADS

~~SECRET~~

UNCLASSIFIED

UNCLASSIFIED

~~SECRET~~

# Nuclear Targeting

---

- Through intelligence data, the targets have a vulnerability number associated with it that allows the DoD to assign a weapon VN number.
- Vulnerability Number (VN)

XXPA   XXQA

First 2 digits are related to the amount of pressure:

- P = over pressure (smash)
  - Q = dynamic pressure (winds)
  - A = adjustment for yield (tables geared to 20 kT)
- A typical VN:  
Airfield = 12 P0 ~ 10 psi

~~SECRET~~

UNCLASSIFIED

UNCLASSIFIED

~~SECRET~~

~~SECRET~~

UNCLASSIFIED

UNCLASSIFIED

~~SECRET~~

~~SECRET~~

UNCLASSIFIED

DD  
73

~~SECRET~~

UNCLASSIFIED

~~SECRET~~

UNCLASSIFIED

UNCLASSIFIED

~~SECRET~~

~~SECRET~~

UNCLASSIFIED

UNCLASSIFIED

~~SECRET~~



~~SECRET~~

UNCLASSIFIED

UNCLASSIFIED

~~SECRET~~

REFERENCES

- THE EFFECTS OF NUCLEAR WEAPONS 3RD EDITION,  
GLASSTONE AND DOLAN, 1977, UNC
  
- CAPABILITIES OF NUCLEAR WEAPONS, DNA EM-1  
PARTS I & II, SRD RS-3141 8798

~~SECRET~~

UNCLASSIFIED

UNCLASSIFIED

~~SECRET~~

# SURVEY OF WEAPONS DEVELOPMENT AND TECHNOLOGY

WR708

SESSION IV

- HIGH EXPLOSIVES
- DETONATORS

~~SECRET~~

UNCLASSIFIED

UNCLASSIFIED

~~SECRET~~

~~SECRET~~

UNCLASSIFIED

**PRIMARY**

- EASILY IGNITED WITH QUICK TRANSITION TO DETONATION
- SMALL QUANTITY REQUIRED

**SECONDARY**

- INSENSITIVITY
- HIGH ENERGY DENSITY

**PHYSICAL SEPARATION - TETRYL**

UNCLASSIFIED

~~SECRET~~

Material <sup>a</sup>	Chemical name	Other designations	Color
*BTF	Benzotris-[1,2,5] oxadiazole-[4,4,7]-trioxide	Benzotrifuroxan, hexanitrosobenzene	Buff
*DATB	1,3-Diamino-2,4,6-trinitrobenzene		Yellow
*DIPAM	3,3-Diamino-2,2',4,4',6,6'-hexanitrobiphenyl	Hexanitrodiphenylamine hexite, dipicrylamine	—
*DNPA	2,2-Dinitropropyl acrylate		Off-white
*EDNP	Ethyl-4,4-dinitropentanoate		Yellow
*FEFO	Bis(2-fluoro-2,2-dinitroethyl)-formal		Straw
**HMX	1,3,5,7-Tetranitro-1,3,5,7-tetraazacyclooctane	Cyclotetramethylene tetranitramine, octogen	White
*HNAB	2,2',4,4',6,6'-Hexanitroazobenzene		Orange
*HNS	2,2',4,4',6,6'-Hexanitrostilbene		Yellow
**NC (12% N) <sup>b</sup>	Partially nitrated cellulose	Nitrocellulose (lacquer grade), cellulose trinitrate, piroksilin	White
*NC (13,35% N, min) <sup>b</sup>	Partially nitrated cellulose	Nitrocellulose, guncotton	White
*NG	1,2,3-Propanetriol trinitrate	Nitroglycerin	Clear
*NM	Nitromethane		Clear
*NQ	Nitroguanidine	Aminomethaneamidine	White
**PETN	Pentaerythritol tetranitrate	Penthrite, TEN	White
**RDX	1,3,5-Trinitro-1,3,5-triazacyclohexane, hexahydro-1,3,5-trinitro-s-triazine	Cyclotrimethylene trinitramine, hexogen cyclonite, Gh	White
*TACOT	Tetranitro-1,2,5,6-tetraazadibenzocyclooctatetrene	Tetranitrodibenzo-1,3a,4,6a-tetraazapentalene	Red-orange
**TATB	1,3,5-Triamino-2,4,6-trinitrobenzene		Bright yellow
**Tetryl	2,4,6-Trinitrophenylmethylnitramine		Yellow
**TNM	Tetranitromethane		Clear
**TNT	2,4,6-Trinitrotoluene	Trotyl, T,tol	buff to brown

<sup>b</sup>Denotes it has been used in nuclear weapons

~~SECRET~~

UNCLASSIFIED

UNCLASSIFIED

~~SECRET~~

## Cast explosives: names and formulations.

Explosive <sup>a</sup>	Formulation (wt%) <sup>b</sup>		
	TNT	RDX	Other ingredients
Baratol	24		Ba(NO <sub>3</sub> ) <sub>2</sub> 76
Boracitol	40		Boric Acid 60
*Comp B, Grade A <sup>c</sup>	36	63	Wax 1
Comp B-3	40	60	
*Cyclotol <sup>d</sup>	25	75	
H-6	30	45	Wax 5
			Al 20
			CaCl <sub>2</sub> 0.5
*Octol	25		HMX 75
*Pentolite <sup>d</sup>	50		PETN 50
Tritonal	80		Al 20

<sup>a</sup>Properties of materials marked with asterisks are summarized in data sheets (Section IV).

<sup>b</sup>The weight percent values given in the table are nominal and subject to some variation.

<sup>c</sup>Comp B, Grade A is formulated as a 60/40 RDX/TNT mixture, but high-quality castings usually are higher in RDX content due to the removal of a TNT-rich section at the top of the casting.

<sup>d</sup>There are several cyclotols and pentolites. The most common cyclotol is RDX/TNT 75/25. The most common pentolite is PETN/TNT 50/50.

~~SECRET~~

UNCLASSIFIED

UNCLASSIFIED

~~SECRET~~

Plastic-bonded explosives: Names and formulations.

Explosive <sup>a</sup>	Other ingredients	Formulation		Color
		Ingredient	wt%	
*LX-04-1	PBHV-85/15	HMX	85	Yellow
		Viton A	15	
*LX-07-2	RX-04-BA	HMX	90	Orange
		Viton A	10	
*LX-09-0	RX-09-CB	HMX	93	Purple
		pDNPA	4.6	
		FEFO	2.4	
LX-09-1		HMX	93.3	Purple
		pDNPA	4.4	
		FEFO	2.3	
*LX-10-0	RX-04-DE	HMX	95	Blue-green spots on white
		Viton A	5	
LX-10-1		HMX	94.5	Blue-green spots on white
		Viton A	4.5	
*LX-11-0	RX-04-PI	HMX	80	White
		Viton A	20	
*LX-14-0		HMX	95.5	Violet spots on white
		Estane		
		5702-FI	4.5	
*PBX-9007	PBX-9007 Type B	RDX	90	White or mottled gray
		Polystyrene	9.1	
		Di(2-ethyl- hexyl)- phthalate	0.5	

~~SECRET~~

UNCLASSIFIED

UNCLASSIFIED

~~SECRET~~

## Plastic-bonded explosives: Names and formulations. (cont.)

		Formulation		
*PBX-9010		Rosin	0.4	
		RDX	90	White
		Kel-F	10	
*PBX-9011	X-0008	HMX	90	Off-white
		Estane		
		5740-X2		
*PBX-9205		RDX	92	White
		Polystyrene	6	
		Di(2-ethyl- hexyl)- phthalate	2	
*PBX-9404	PBX-9404-03	HMX	94	White or blue
		NC (12.0% N)	3	
		Tris (B-chloro- ethyl)- phosphate	3	
*PBX-9407		RDX	94	White or black
		Exon 461	6	
*PBX-9501		HMX	95	White
		Estane	2.5	
		BDNPA	1.25	
		BDNPF	1.25	
PBX-9502		TATB	.05 Kel F	
LX-17		TATB	.075 Kel F	

~~SECRET~~

UNCLASSIFIED

UNCLASSIFIED

~~SECRET~~



~~SECRET~~

UNCLASSIFIED

B-5

UNCLASSIFIED

~~SECRET~~

~~SECRET~~

UNCLASSIFIED

UNCLASSIFIED

b (3)

~~SECRET~~

~~SECRET~~

UNCLASSIFIED

b (3)

UNCLASSIFIED

~~SECRET~~

b (3)

~~SECRET~~

UNCLASSIFIED

UNCLASSIFIED

~~SECRET~~

~~SECRET~~

UNCLASSIFIED

UNCLASSIFIED

~~SECRET~~

b (3)

~~SECRET~~

UNCLASSIFIED

UNCLASSIFIED

~~SECRET~~

~~SECRET~~

UNCLASSIFIED

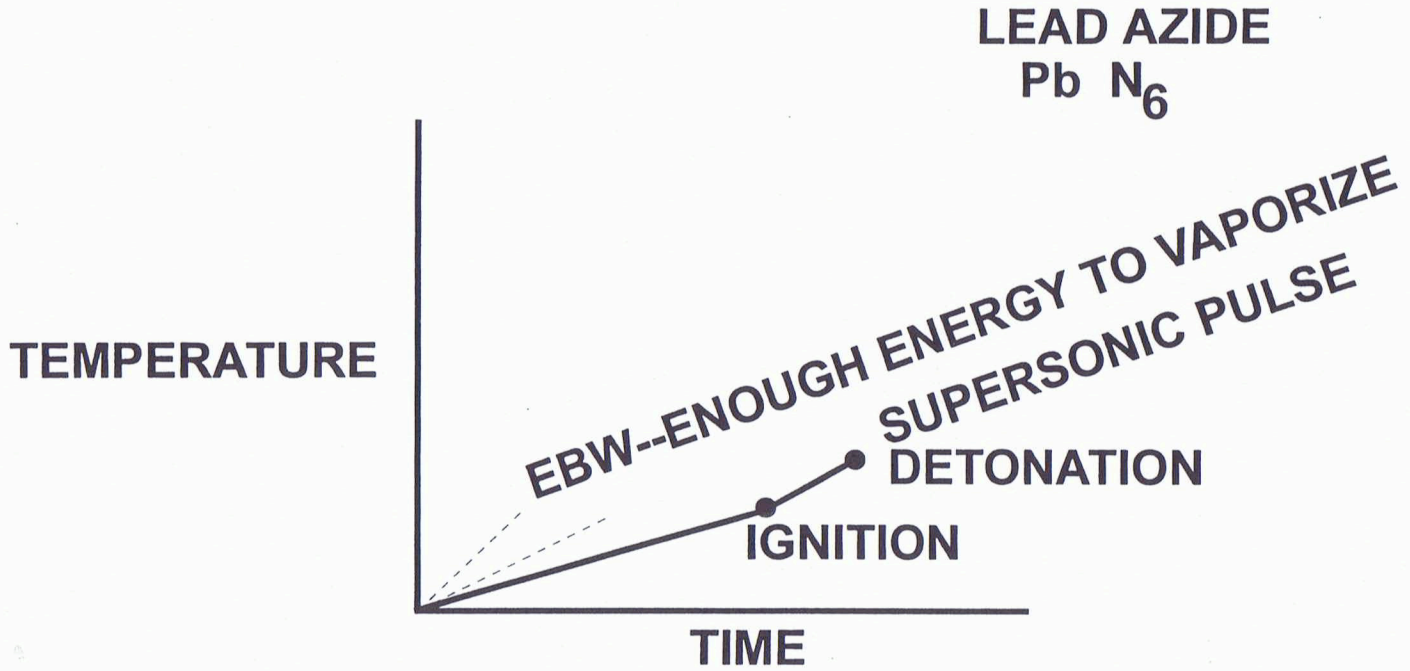

EBW (EXPLODING BRIDGEWIRE) EVOLVED

UNCLASSIFIED

~~SECRET~~

~~SECRET~~

UNCLASSIFIED

UNCLASSIFIED

~~SECRET~~



b (3)

~~SECRET~~  
UNCLASSIFIED

UNCLASSIFIED

~~SECRET~~

A

b(3)

~~SECRET~~

UNCLASSIFIED

UNCLASSIFIED

~~SECRET~~

~~SECRET~~

UNCLASSIFIED

UNCLASSIFIED

~~SECRET~~

b (3)

~~SECRET~~

UNCLASSIFIED

UNCLASSIFIED

~~SECRET~~

~~SECRET~~

UNCLASSIFIED

1

UNCLASSIFIED

~~SECRET~~

~~SECRET~~  
UNCLASSIFIED

UNCLASSIFIED

~~SECRET~~

~~SECRET~~

UNCLASSIFIED

UNCLASSIFIED

~~SECRET~~

~~SECRET~~

UNCLASSIFIED

UNCLASSIFIED

~~SECRET~~

b(3)



## **REFERENCES**

- **AN INTRODUCTION TO NUCLEAR WEAPONS;  
WASH 1037 REVISED; GLASSTONE, JUNE 1972**
- **PROPERTIES OF CHEMICAL EXPLOSIVES AND  
EXPLOSIVE SIMULANTS; LLL JULY 31, 1974,  
DOBRATZ UCRL - 51319, REV 1**
- **SENSITIVITY OF INITIATION-SYSTEM DETONATORS:  
REVIEW OF CURRENT AND ADVANCED TECHNOLOGIES;  
R. E. SETCHELL; SAND91-1590**

~~SECRET~~

UNCLASSIFIED

UNCLASSIFIED

~~SECRET~~

UNCLASSIFIED

~~SECRET~~

THIS PAGE LEFT BLANK INTENTIONALLY

UNCLASSIFIED

~~SECRET~~

~~SECRET~~

UNCLASSIFIED

No Notes for this Section

UNCLASSIFIED

~~SECRET~~

## ***REFERENCES***

- AN INTRODUCTION TO NUCLEAR WEAPONS;  
WASH 1037 REVISED, GLASSTONE, JUNE 1972
- SOURCE BOOK ON ATOMIC ENERGY;  
GLASSTONE, 3rd EDITION
- NUCLEAR TEST SUMMARY TRINITY — HARDTACK  
DASA 1220; RS3141/10349
- VARIOUS WEAPON DEVELOPMENT REPORTS

~~SECRET~~

UNCLASSIFIED

UNCLASSIFIED

~~SECRET~~

~~SECRET~~

UNCLASSIFIED

**No Notes for this Section**

UNCLASSIFIED

~~SECRET~~

## *REFERENCES*

- AN INTRODUCTION TO NUCLEAR WEAPONS;  
WASH 1037 REVISED, GLASSTONE, JUNE 1972
- SOURCE BOOK ON ATOMIC ENERGY;  
GLASSTONE, 3rd EDITION
- NUCLEAR TEST SUMMARY TRINITY — HARDTACK  
DASA 1220; RS3141/10349
- VARIOUS WEAPON DEVELOPMENT REPORTS

~~SECRET~~

UNCLASSIFIED

UNCLASSIFIED

~~SECRET~~

# SURVEY OF WEAPONS DEVELOPMENT AND TECHNOLOGY

WR708

SESSION VII

- NUCLEAR DETONATION SAFETY
- NUCLEAR MATERIAL SCATTER

~~SECRET~~

UNCLASSIFIED

UNCLASSIFIED

~~SECRET~~

# Surety

*PART OF A LAYERED NATIONAL PROGRAM PROTECTING AGAINST UNAUTHORIZED NUCLEAR DETONATION OR PLUTONIUM SCATTER*

THE ADVERSARY: → Accidents - Safety  
Humans - Security & Use Control

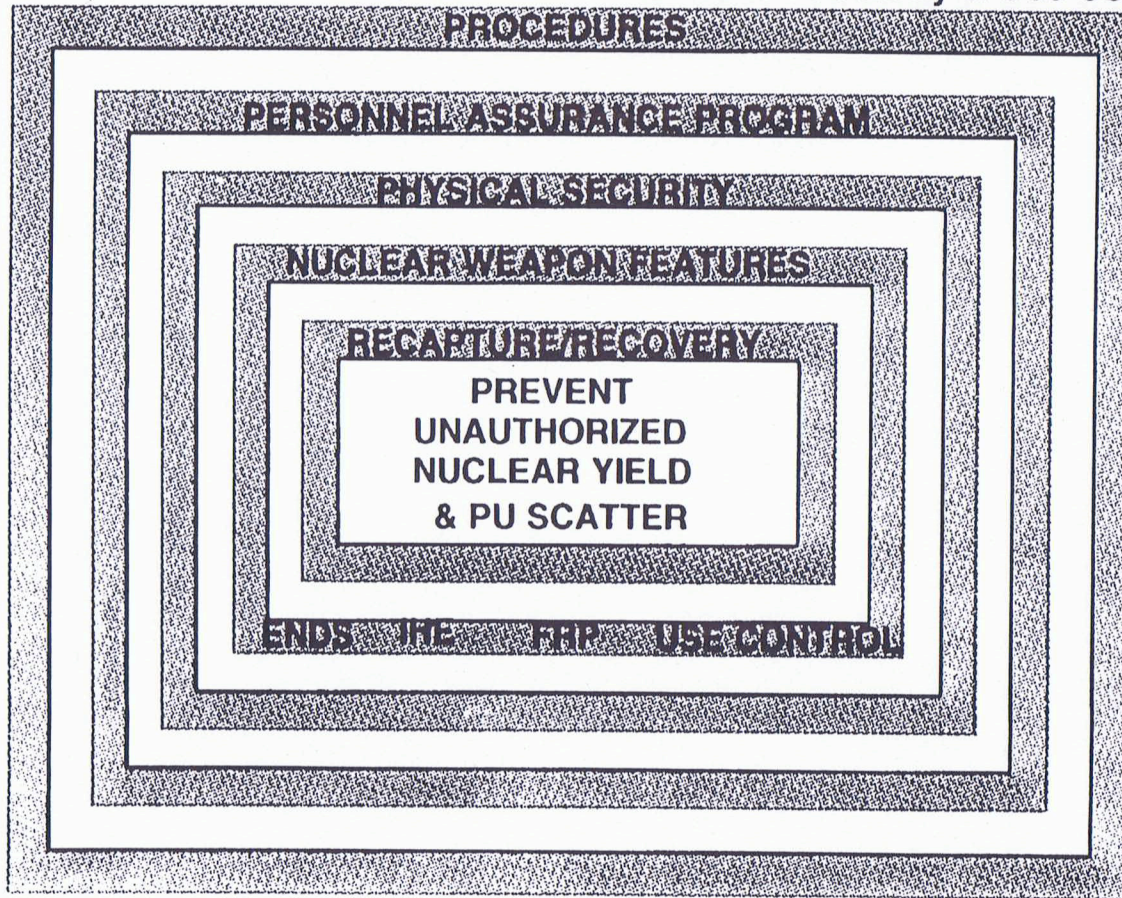

UNCLASSIFIED

~~SECRET~~

UNCLASSIFIED

~~SECRET~~



# Nuclear Weapon Surety aims to prevent three consequences

---

Nuclear yield - release of nuclear energy greater than the energy of four pounds of high explosive

Launch or release - sending a nuclear weapon toward a target

Pu dispersal - release of plutonium outside the weapon

~~SECRET~~

UNCLASSIFIED

UNCLASSIFIED

~~SECRET~~

# The goal of surety standards

---

Compliance with nuclear weapon system surety standards should provide assurance against undesired consequences (nuclear yield, launch, or Pu dispersal) resulting from any causes (either intended or unintended).

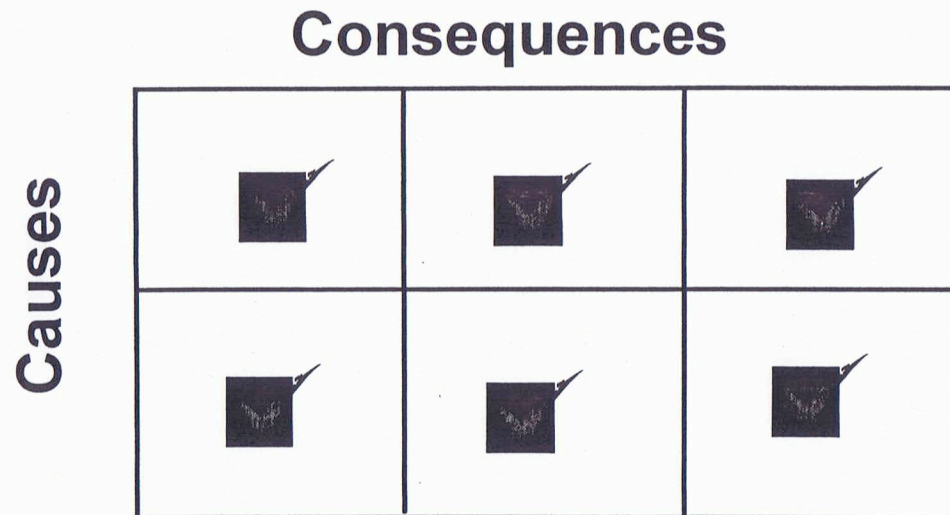

~~SECRET~~

UNCLASSIFIED

UNCLASSIFIED

~~SECRET~~

# The dual approach to nuclear weapons safety

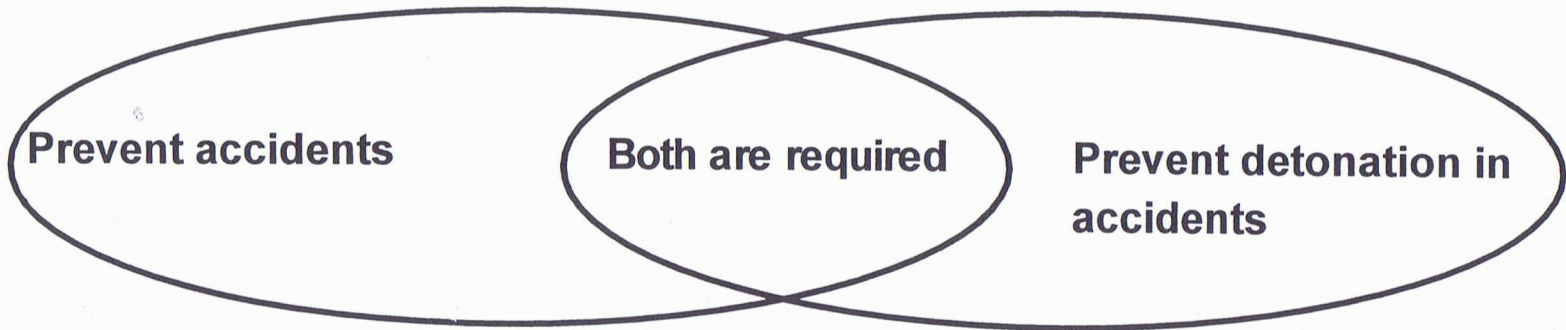
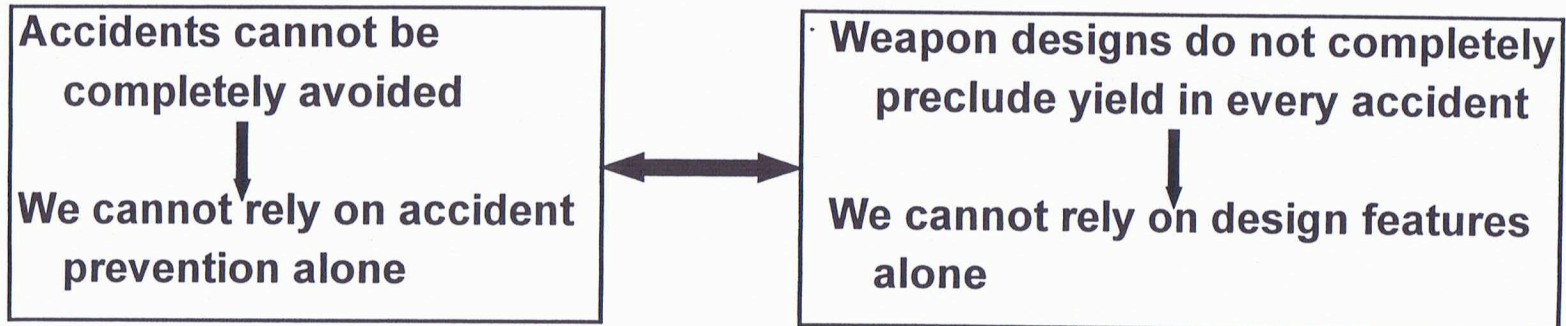

~~SECRET~~

UNCLASSIFIED

UNCLASSIFIED

~~SECRET~~

# DOE shares responsibility for safety, security, and control

From the 1983 Memorandum of Understanding between DOE and DoD on Objectives and Responsibilities for Joint Nuclear Weapon Activities

"The obligation of the DoD and the DOE to protect public health and safety provides the basic premise for dual-agency judgment and responsibility for safety, security and control (S<sup>2</sup>C) of nuclear weapons. This check-and-balance role shall continue. The DoD and the DOE share the responsibility to:

- 1) Identify and resolve health and safety problems connected with nuclear weapons. In particular, the DOE has a continuing responsibility to participate with the DoD in the consideration of these health and safety problems for nuclear weapons in DoD custody.
- 2) Prevent unauthorized use of a nuclear weapon through the use of positive control measure...
- 3) Determine the adequacy and effectiveness of physical security measures..."

~~SECRET~~

UNCLASSIFIED

UNCLASSIFIED

~~SECRET~~

# Department of Defense Directive

## 3150.2

Replaces DoD 5030.15...February 8, 1984

### SAFETY STANDARDS

---

1. There shall be positive measures to prevent nuclear weapons involved in accidents or incidents, or jettisoned weapons, from producing a nuclear yield.
2. There shall be positive measures to prevent deliberate prearming, arming, launching, firing, or releasing of nuclear weapons, except upon execution of emergency war orders or when directed by competent authority.
3. There shall be positive measures to prevent inadvertent prearming, arming, launching, firing, or releasing of nuclear weapons in all normal and credible abnormal environments.
4. There shall be positive measures to ensure adequate security of nuclear weapons, pursuant to DoD Directive 5210.41.

~~SECRET~~

UNCLASSIFIED

UNCLASSIFIED

~~SECRET~~

# DOE Order 5610.10

10/10/90

## Nuclear Explosive Safety Standards

---

- a. There shall be positive measures to prevent nuclear explosives involved in accidents or incidents from producing a nuclear yield.
- b. There shall be positive measures to prevent deliberate prearming, arming, or firing of a nuclear explosive except when directed by competent authority.
- c. There shall be positive measures to prevent the inadvertent prearming, arming, launching, firing, or releasing of a nuclear explosive in all normal and credible abnormal environments.
- d. There shall be positive measures to ensure adequate security of nuclear explosives pursuant to the DOE safeguards and security requirements.
- e. There shall be positive measures to prevent accidents, inadvertent, or deliberate unauthorized dispersal of plutonium to the environment.

~~SECRET~~  
UNCLASSIFIED

UNCLASSIFIED  
~~SECRET~~

# DOE Nuclear Explosive Surety Standard

---

All DOE nuclear explosive operations shall meet the the following qualitative surety standards to prevent unintended nuclear detonation, fissile material dispersal from the pit, or loss of control. There shall be positive measures to:

- Minimize the possibility of accidents, inadvertent acts, or authorized activities that could lead to fire, high explosive deflagration, or unintended high explosive detonation;
- Minimize the possibility of fire, high explosive deflagration, or high explosive detonation, given accidents or inadvertent acts;
- Minimize the possibility of deliberate unauthorized acts that could lead to high explosive deflagration or high explosive detonation;
- Ensure adequate security of nuclear explosives;
- Minimize the possibility of or delay unauthorized nuclear detonation.

Reference: DOE Order 452.1, October 4, 1996

~~SECRET~~

UNCLASSIFIED

UNCLASSIFIED

~~SECRET~~

## Positive Measures

---

From DOE Order 5610.10

- Design features, safety rules, procedures, or other controls used individually or collectively to provide nuclear explosive safety.
- Positive measures are intended to assure a safe response in applicable operations and be controllable.
- Examples
  - strong-link switches
  - other safety devices
  - administrative procedures and controls
  - general and specific nuclear explosive safety rules
  - design control of electrical equipment and mechanical tooling
  - physical, electrical, and mechanical restraints
  - incorporated in facilities and transport equipment

~~SECRET~~

UNCLASSIFIED

UNCLASSIFIED

~~SECRET~~



# Explanation of normal and abnormal environments

---

Normal environments (temperature, shock, electrical connections, etc.) are those defined in the weapon or system specifications and intended to be tolerated by the weapon or system. The system is designed to function normally during its entire lifetime if it experiences normal environments.

Abnormal environments are conditions experienced by the weapon or system that are outside the defined normal environments (more extreme temperatures, shocks, voltages, etc.). The weapon or system is not required to function after exposure to an abnormal environment.

UNCLASSIFIED

~~SECRET~~

UNCLASSIFIED

~~SECRET~~

# OPERATIONS & SAFETY DESIGN MUST BE BALANCED

~~SECRET~~

UNCLASSIFIED

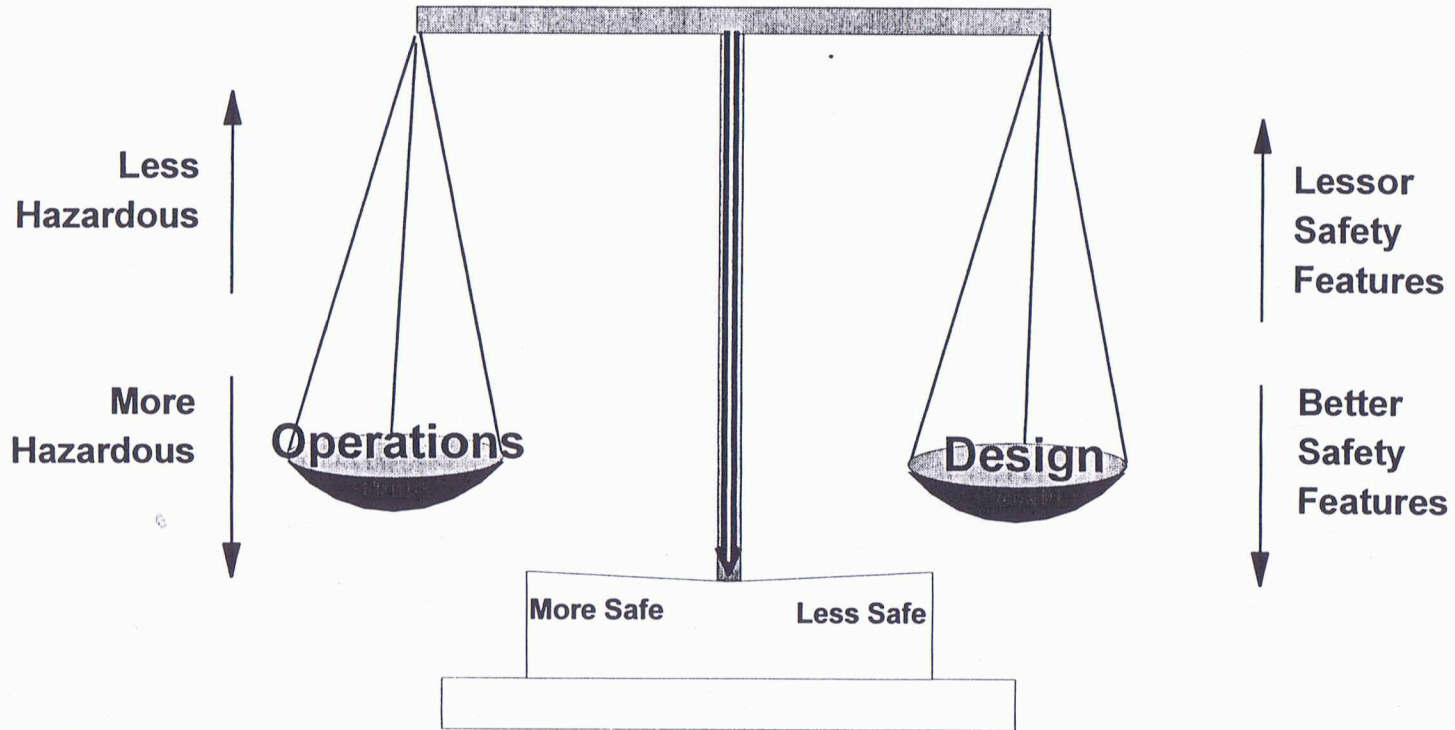

UNCLASSIFIED

~~SECRET~~

# U. S. NUCLEAR DEPLOYMENTS CHANGED

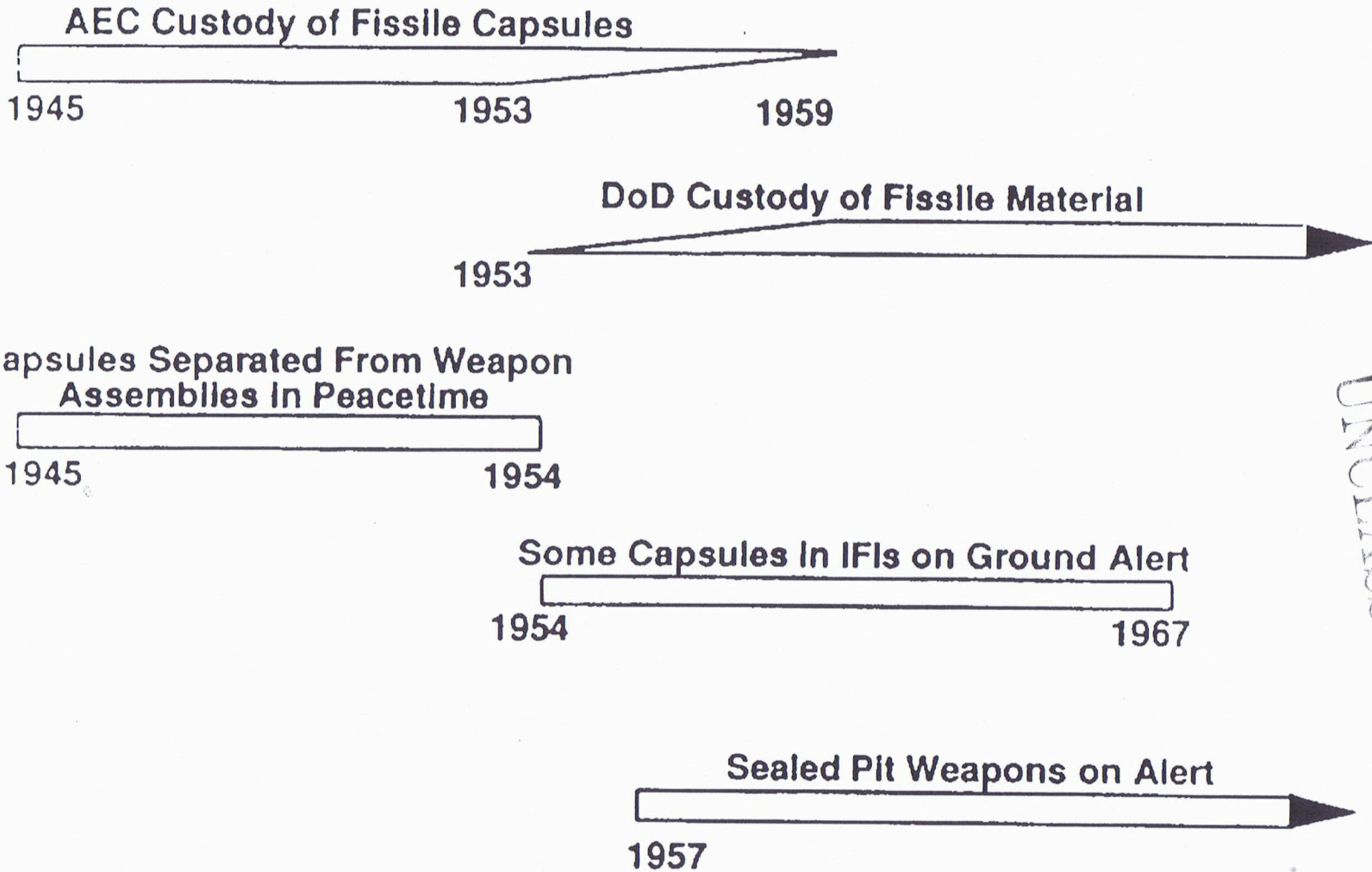

UNCLASSIFIED

~~SECRET~~

UNCLASSIFIED

~~SECRET~~

# Manually Inserted Capsules

---

1948 - 1951

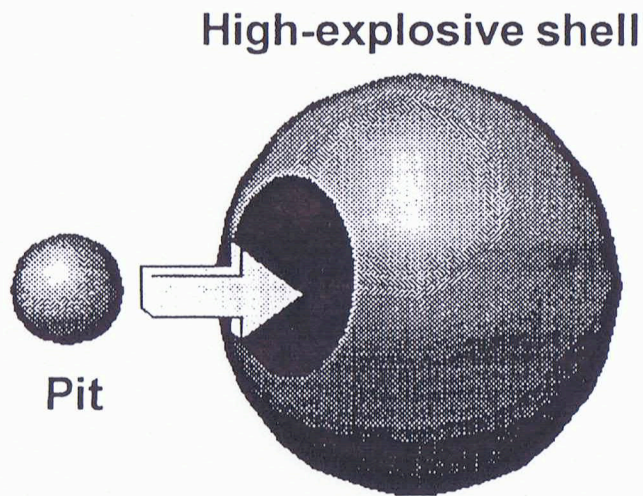

- **Safety Theme: Separation of fissile material and HE**
- **Analysis: Accident must assemble weapon**

~~SECRET~~

UNCLASSIFIED

UNCLASSIFIED

~~SECRET~~

# Mechanically Inserted Capsules

1952 - 1967

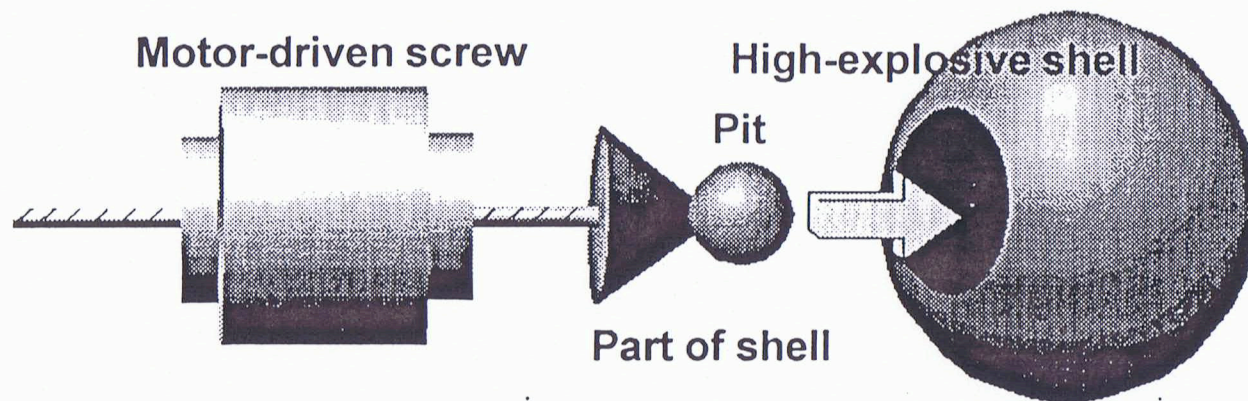

- Safety Theme: Separation of fissile material and HE and electrical isolation

- Analysis: Accident could assemble weapon by operating motor or by mechanical damage

~~SECRET~~

UNCLASSIFIED

UNCLASSIFIED

~~SECRET~~

# Sealed-pit Weapons

---

1957

High-explosive  
shell

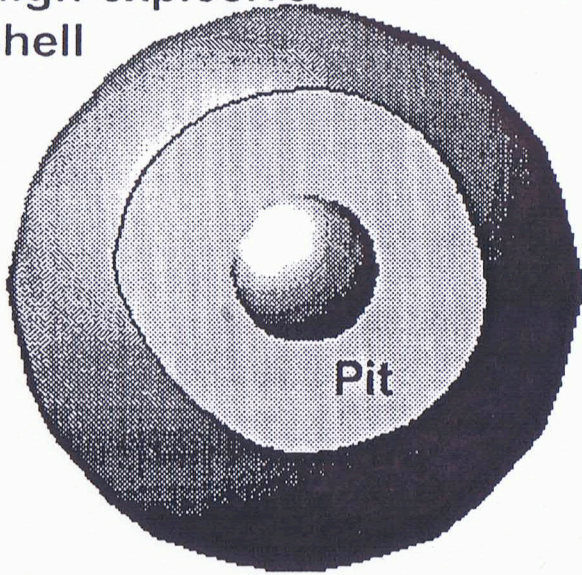

Pit

- **Safety Theme: Electrical isolation and one-point safety**
- **Analysis: Accident could generate firing signals; not one-point safe**

~~SECRET~~

UNCLASSIFIED

UNCLASSIFIED

~~SECRET~~

# EVOLUTION OF NUCLEAR SAFETY

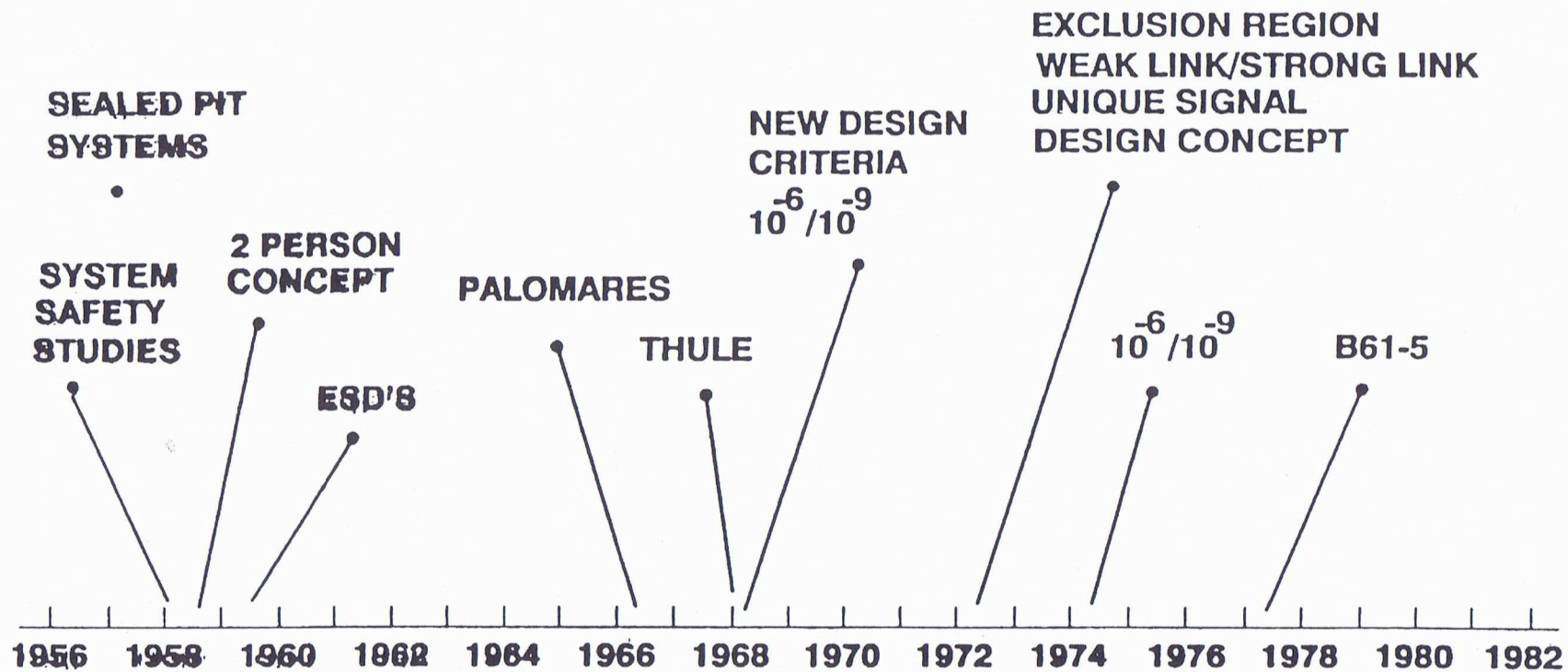

UNCLASSIFIED

~~SECRET~~

~~SECRET~~

UNCLASSIFIED

# Early Electrical Isolation Safety Features

---

1950 - 1970

- Removable safing plugs
- Circuit board and cable isolation
- Removable or external power supplies
- Ready-safe switches
- Thermal fuses
- Environmental sensing devices

~~SECRET~~

UNCLASSIFIED

UNCLASSIFIED

~~SECRET~~



# Environmental Sensing Devices (ESDs)

---

An open switch in the prearming circuits.

It is closed after sensing an environment experienced by the weapon system when enroute to the target.

~~SECRET~~

UNCLASSIFIED

UNCLASSIFIED

~~SECRET~~

# US Nuclear Weapon Accidents

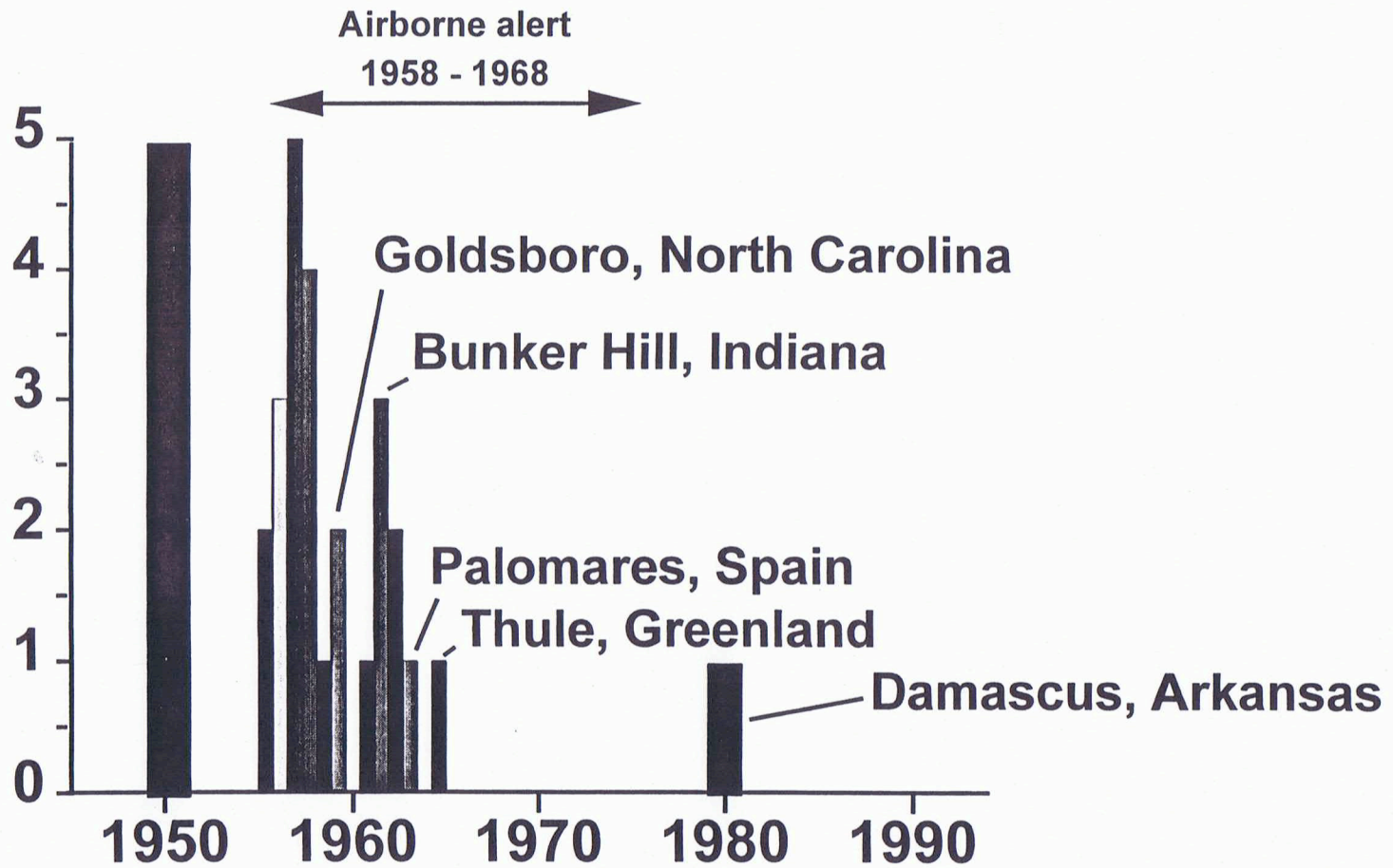

SECRET

UNCLASSIFIED

Number

UNCLASSIFIED

SECRET

~~SECRET~~

UNCLASSIFIED

b (3)

UNCLASSIFIED

~~SECRET~~

b (3)

UNCLASSIFIED

~~SECRET~~

UNCLASSIFIED

~~SECRET~~

~~SECRET~~

UNCLASSIFIED

**B-52G INCIDENT  
GRAND FORKS AFB  
15 SEPTEMBER 1980**

**DURING A CARTRIDGE START FOR AN ALERT EXERCISE, AN ALERT CONFIGURED B-52G EXPERIENCED A FIRE IN THE NUMBER 5 ENGINE. 30 KNOT WIND WAS FORTUITOUSLY BLOWING FROM DIRECTION DIRECTLY AFT OF AIRCRAFT. FIRE WAS FOUGHT FOR THREE HOURS BEFORE FUEL FLOW TO ENGINE POD WAS SHUT OFF AND FLAMES EXTINGUISHED. ENGINE POD AND LEADING EDGE OF WING WERE DAMAGED, ALONG WITH SOME MINOR DAMAGE TO FUSELAGE SKIN.**

UNCLASSIFIED

~~SECRET~~

b(5)

# Nuclear Weapon Accident--Definition

## DOD Directive 5100.52

---

An unexpected event involving nuclear weapons or nuclear components that results in any of the following:

- (1) Accidental or unauthorized launching, firing, or use by U.S. forces or U.S. supported allied forces of a nuclear capable weapon system.
- (2) An accidental, unauthorized, or unexplained nuclear detonation.
- (3) Non-nuclear detonation or burning of a nuclear weapon or nuclear component.
- (4) Radioactive contamination.
- (5) Jettisoning of a nuclear weapon or nuclear component.
- (6) Public hazard, actual or perceived.

~~SECRET~~  
UNCLASSIFIED

UNCLASSIFIED

~~SECRET~~

~~SECRET~~

UNCLASSIFIED

UNCLASSIFIED

~~SECRET~~

b (3)

DOE  
b(3)

~~SECRET~~

UNCLASSIFIED

~~SECRET~~

UNCLASSIFIED



~~SECRET~~

UNCLASSIFIED

---

**Accidents (mainly air-delivered systems) eventually led to reexamination of the premature nuclear yield criteria and to the present nuclear detonation safety design criteria.**

UNCLASSIFIED

~~SECRET~~

## Need for a Safety Process

---

- As the deployment dates for sealed pit weapons approached, the Armed Forces Special Weapons Project (AFSWP) and the Services became uncomfortable with their lack of knowledge and understanding of weapon safety designs.
- 1957, AFSWP convened a safety Board to examine the sealed pit weapon systems becoming available.
- Between 1957 and 1960, the Air Force convened joint safety study groups as weapons entered the stockpile.
- A formal, Joint DoD/DOE Nuclear Weapons System Safety process was established in 1960.

~~SECRET~~

UNCLASSIFIED

~~SECRET~~

UNCLASSIFIED

# DoD/DOE Nuclear Weapon Safety Process

---

- **Joint Safety Study of Each Weapon System and Operational Concept**
  - **Determine if Weapon System Meets the 4 Qualitative Standards**
  - **Develop Operation Safety Rules**

and

- **Ensure Maximum Safety Consistent with Operational Requirements**

~~SECRET~~

UNCLASSIFIED

UNCLASSIFIED

~~SECRET~~

## 1968 -- DoD/DOE Agree on Premature Nuclear Detonation Design Safety Criteria

---

- The probability of a premature nuclear detonation due to component malfunctions, in the absence of any input signals except for specified (e.g. monitoring and control), shall not exceed.

(1) For normal storage and operational environments described in the STS, 1 in  $10^9$  per weapon lifetime.

(2) For the abnormal environments described in the STS, 1 in  $10^6$  per weapon exposure or accident.

~~SECRET~~

UNCLASSIFIED

UNCLASSIFIED

~~SECRET~~

# 1968 -- DoD/DOE Agree on One-Point Detonation Design Safety Criteria

---

## One Point Safety

- a. In the event of a detonation initiated at any one point in the high explosion system, the probability of achieving a nuclear yield greater than four pounds TNT equivalent shall not exceed one in one million.
- b. One-point safety shall be inherent in the nuclear design, that is, it shall be obtained without the use of a nuclear safing device.

~~SECRET~~

UNCLASSIFIED

UNCLASSIFIED

~~SECRET~~

## Four Pounds

---

**“The four pounds TNT equivalent evolved from a U.S. Navy requirement based upon personnel exposure in the engine room of an aircraft carrier resulting from a small nuclear yield occurring on the flight deck 50 feet above the engine room (Ref. 5). A study concluded that a detonation giving a nuclear contribution equivalent to 44 pounds of TNT would result in a 50% sickness dose (SD<sub>50</sub>) of 200 neutron rad to personnel in the engine room. To be conservative, a reliability factor of 10 was applied and the result rounded to four pounds. Another study, conducted in 1967 by the U.S. Army Nuclear Defense Laboratory, concluded that 8.5 pounds TNT equivalent would produce 200 neutron rad at 50 feet. This figure had a reliability factor of two applied and the result rounded to four pounds, also.”**

**Reference: “One-Point Safety,” Defense Science, LANL, March-April 1983**

~~SECRET~~

UNCLASSIFIED

UNCLASSIFIED

~~SECRET~~

~~SECRET~~

UNCLASSIFIED

DOE  
b(3)

UNCLASSIFIED

~~SECRET~~

UNCLASSIFIED

~~SECRET~~

DOE  
b(3)

UNCLASSIFIED

~~SECRET~~



# Conclusion of Stockpile Study

---

***New approach to nuclear  
weapon safety needed***

~~SECRET~~

UNCLASSIFIED

UNCLASSIFIED

~~SECRET~~

# Safety Goals for Abnormal Environments

---

- Assured, predictable, safe response of the warhead electrical system
- Maintain predictable, safe response until intended use
- Minimize safety critical components and dependence on knowing accident scenario

~~SECRET~~

UNCLASSIFIED

UNCLASSIFIED

~~SECRET~~

# Modern Nuclear Safety -- The 4 I's

---

- **Isolation**
  - Barriers**
  - Stronglink switches**
- **Incompatibility**
  - Unique signals**
- **Inoperability**
  - Co-location of stronglinks and weaklinks**
- **Independence of safety subsystems**

~~SECRET~~

UNCLASSIFIED

UNCLASSIFIED

~~SECRET~~

MORE SPECIFICALLY THE SAFETY GOALS ARE TO

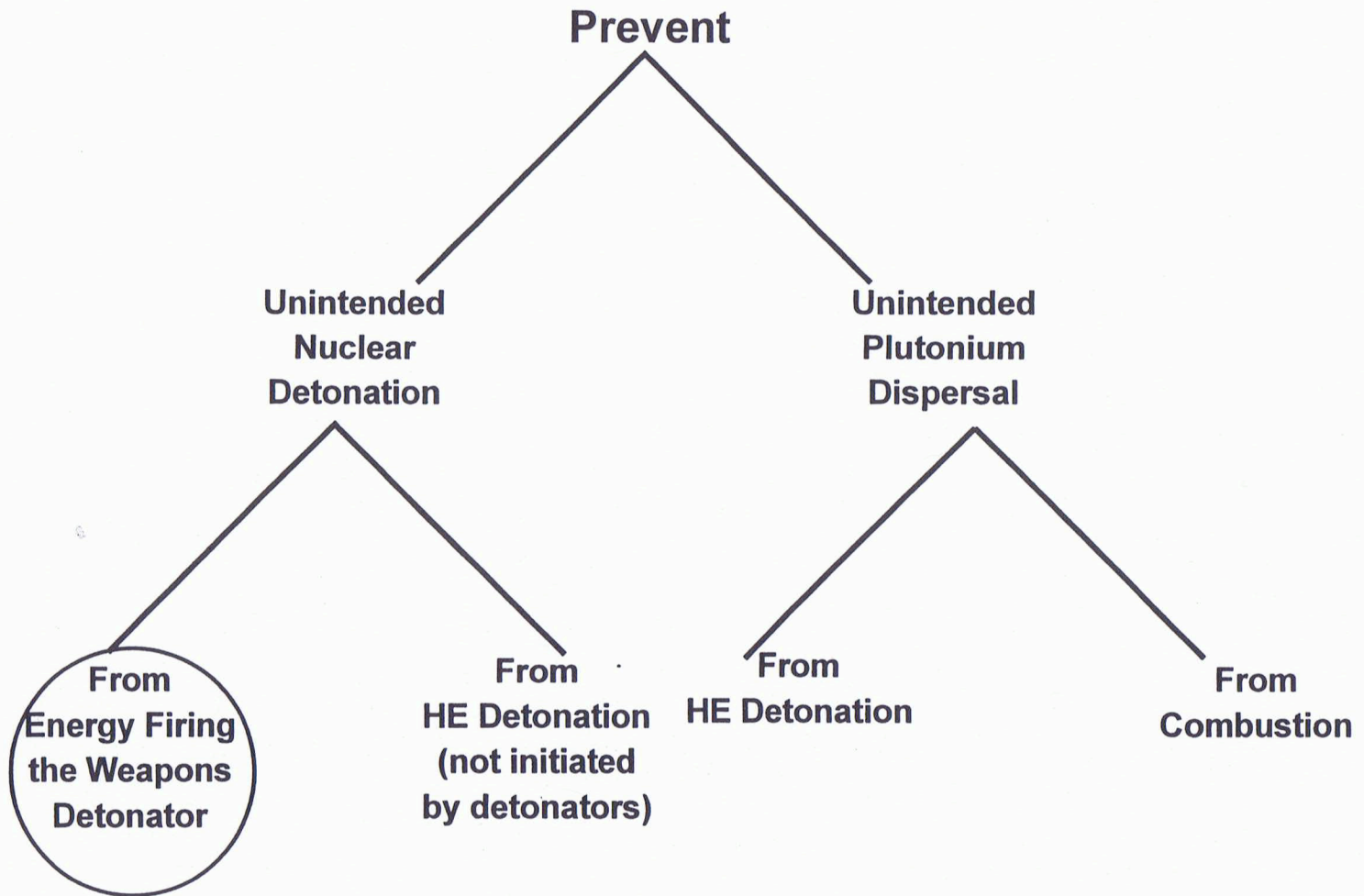

~~SECRET~~

UNCLASSIFIED

UNCLASSIFIED

~~SECRET~~

# MODERN SAFETY DESIGN PHILOSOPHY

Co-locate detonation-essential components and protect them from abnormal environments by an exclusion region

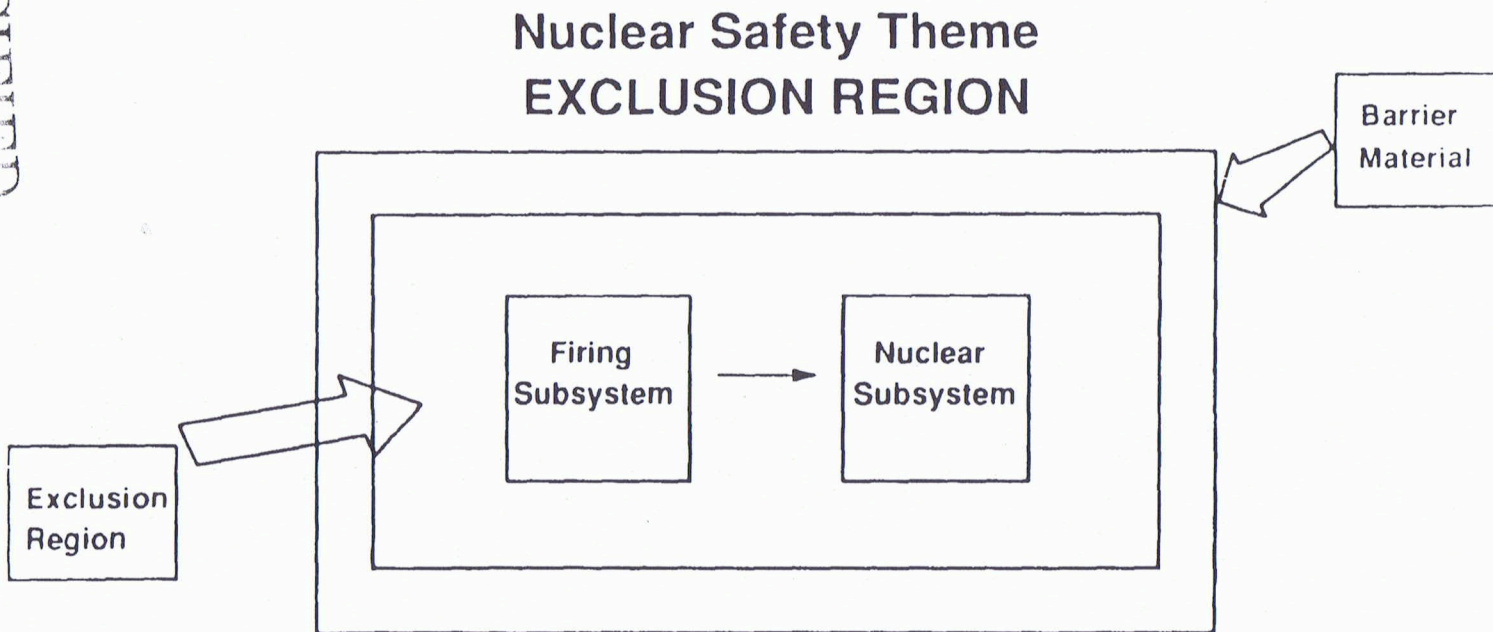

~~SECRET~~

UNCLASSIFIED

UNCLASSIFIED

~~SECRET~~

## MODERN SAFETY DESIGN PHILOSOPHY (cont)

Allow energy/signals into the exclusion region only through a strong link

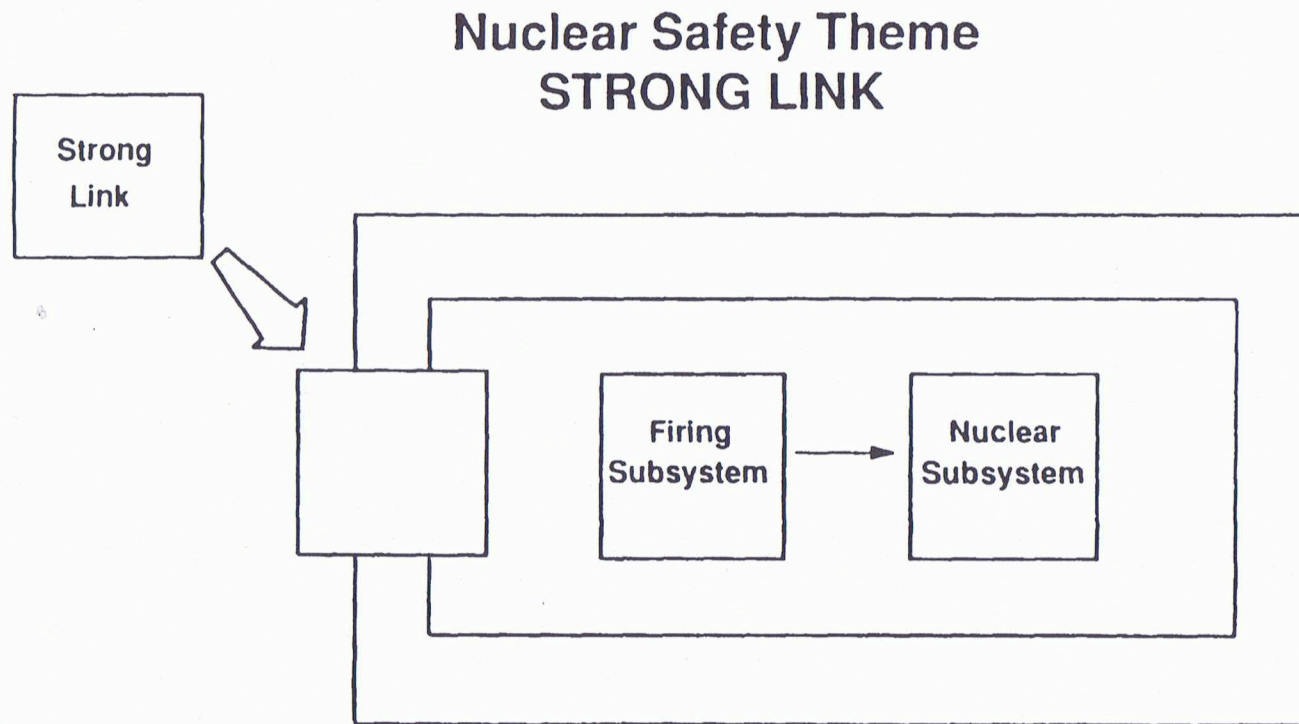

~~SECRET~~

UNCLASSIFIED

~~SECRET~~  
UNCLASSIFIED

# MODERN SAFETY DESIGN PHILOSOPHY (cont)

Control the strong link(s) with a unique signal  
not duplicated elsewhere in the system

## Nuclear Safety Theme UNIQUE SIGNALS

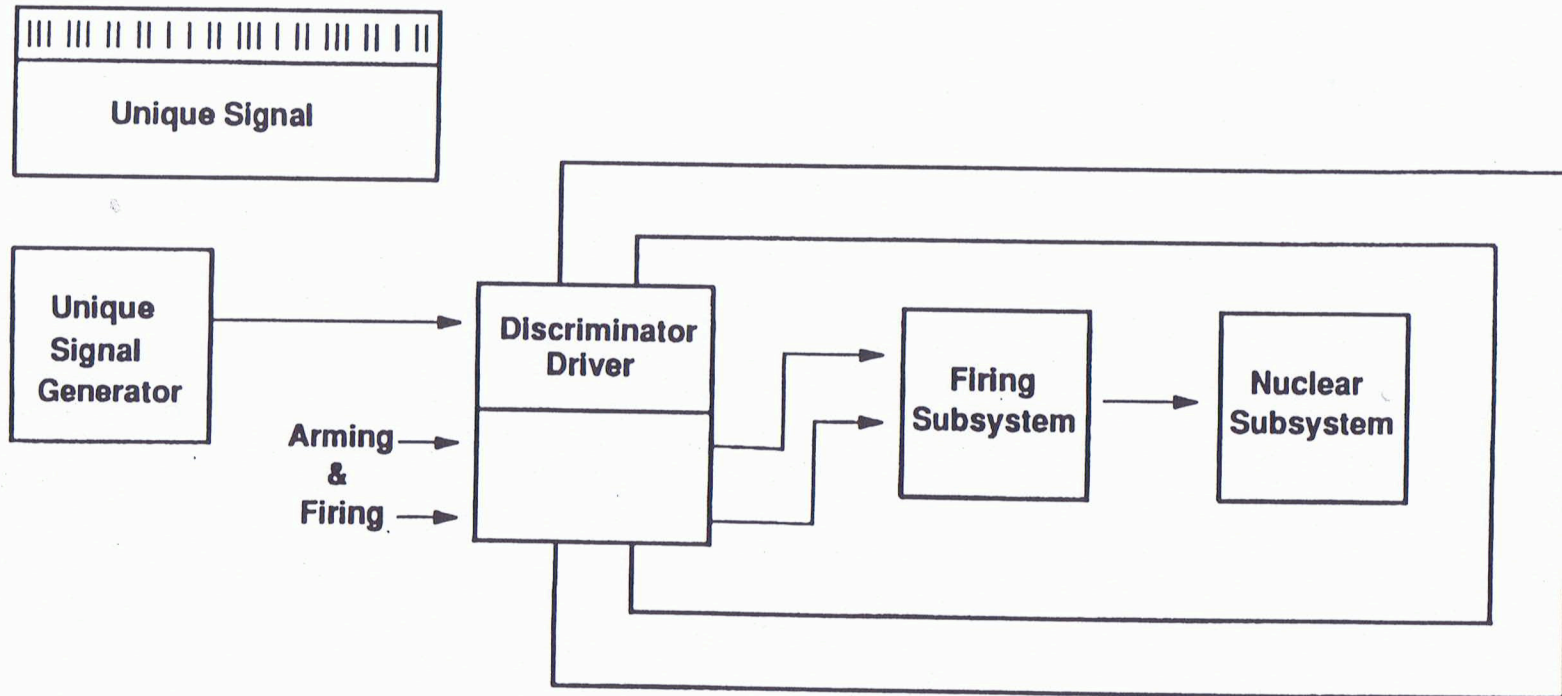

~~SECRET~~

UNCLASSIFIED

UNCLASSIFIED

~~SECRET~~

## MODERN SAFETY DESIGN PHILOSOPHY (cont)

Finally, to address credible but catastrophically severe environments, co-locate *weak link* detonation-essential components which will predictably become inoperable prior to the barrier or strong links losing their integrity.

### Nuclear Safety Theme WEAK LINKS

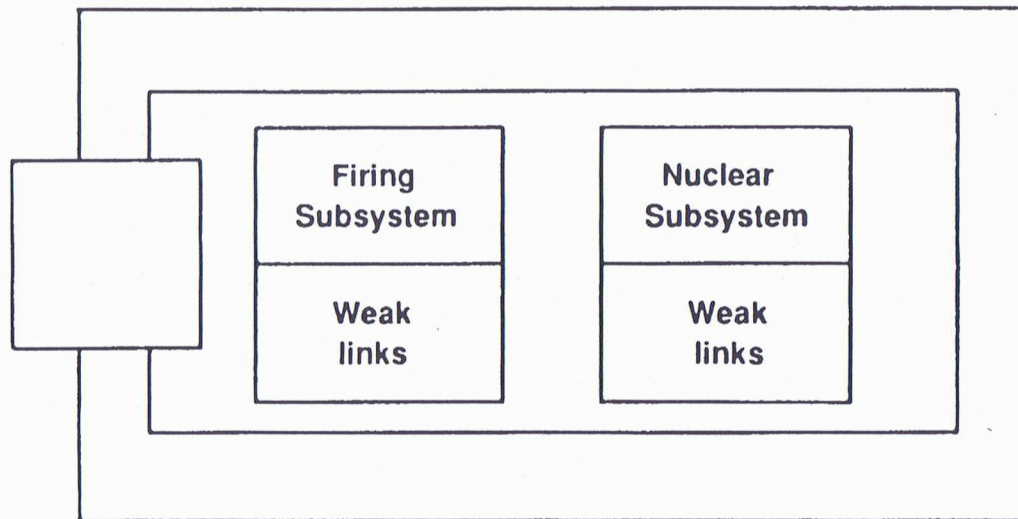

~~SECRET~~

UNCLASSIFIED

UNCLASSIFIED

~~SECRET~~



*BECAUSE THE REQUIREMENT  
(LESS THAN ONE-IN-A-MILLION)  
IS QUITE STRINGENT*

---

**Nuclear Safety Theme  
TWO SAFETY SUBSYSTEMS ARE USED**

(PREARM)  
Human  
Intent  
Unique Signal

Environmental  
Unique Signal  
(PREARM)

Arming  
&  
Firing

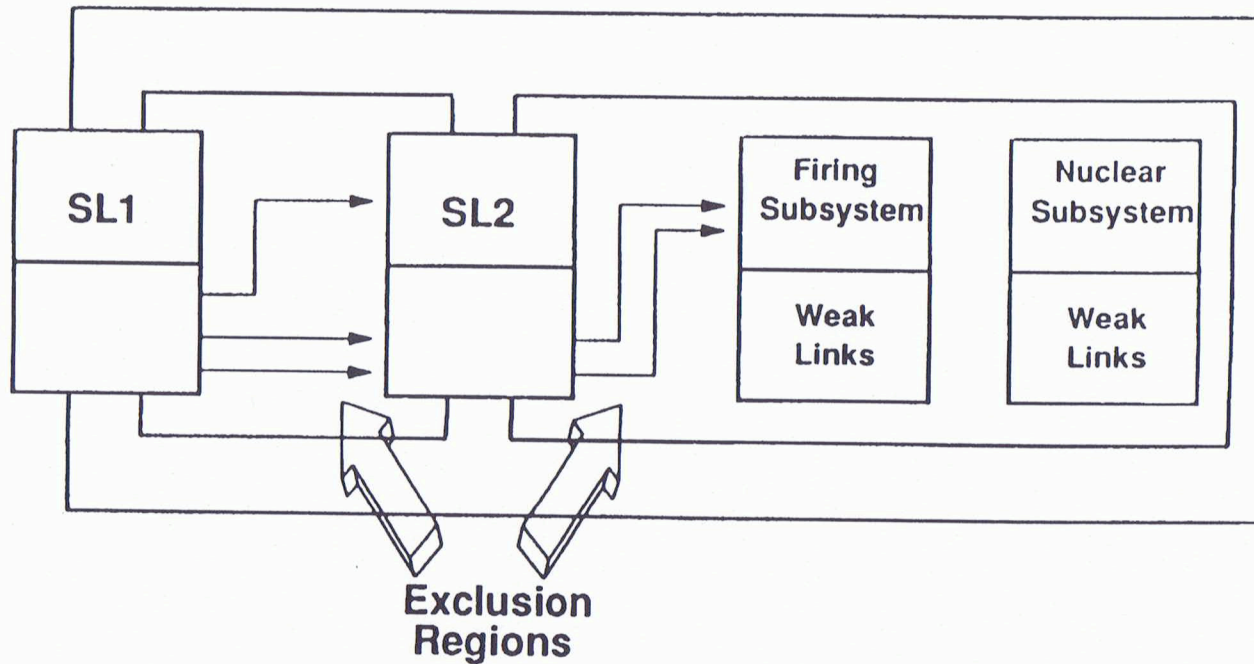

UNCLASSIFIED

~~SECRET~~

UNCLASSIFIED

~~SECRET~~

~~SECRET~~

UNCLASSIFIED

~~SECRET~~

UNCLASSIFIED

130  
5/1

~~SECRET~~

UNCLASSIFIED

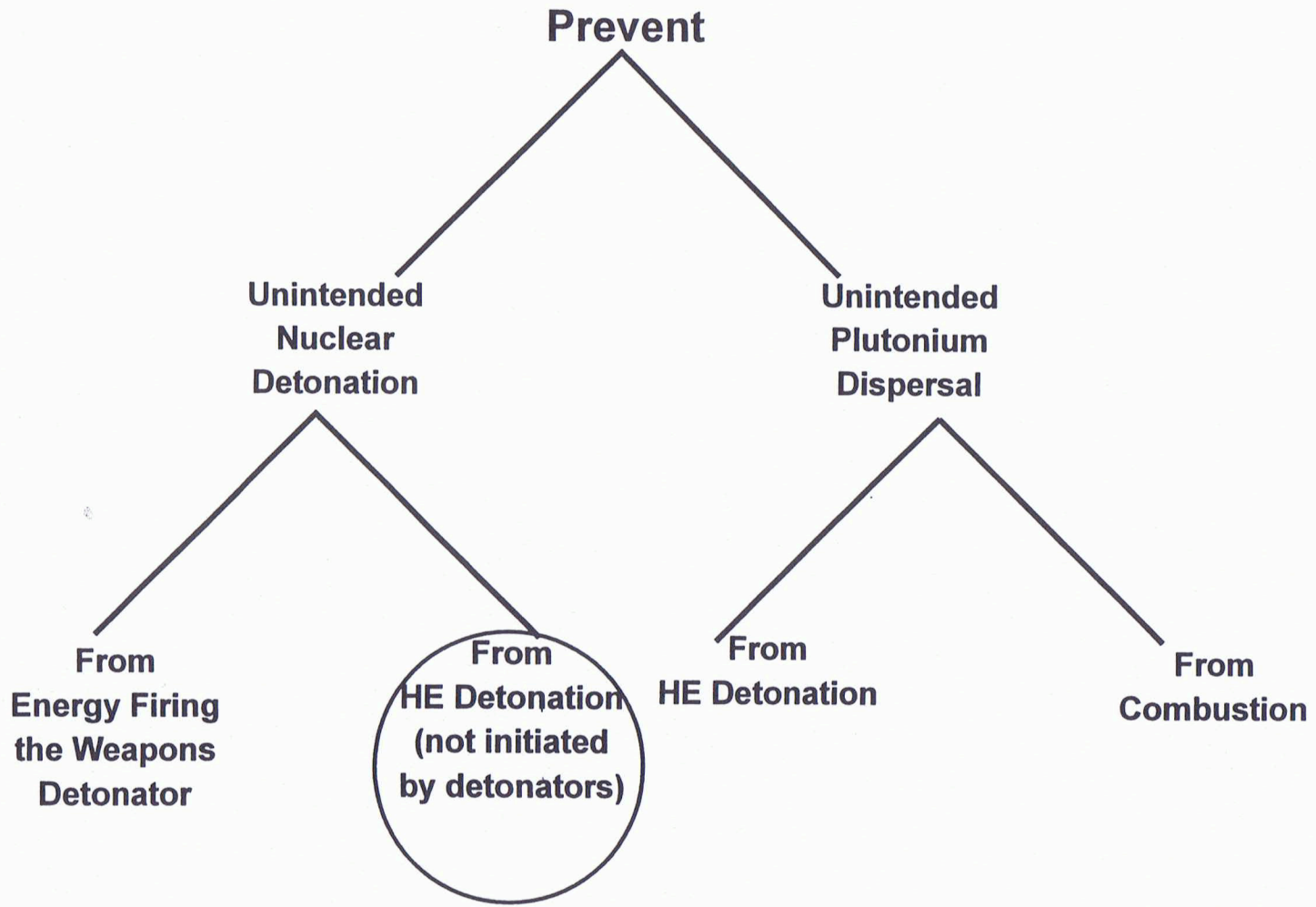

UNCLASSIFIED

~~SECRET~~

# ONE POINT SAFETY

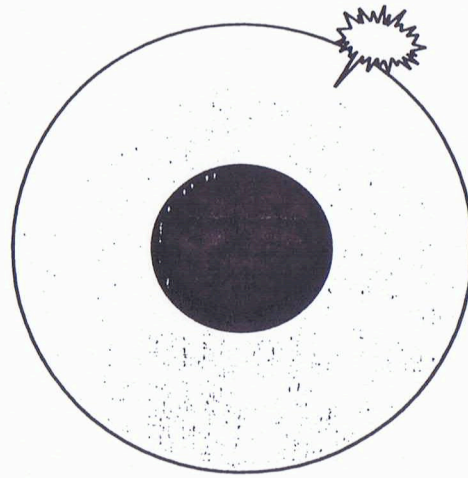

~~SECRET~~

UNCLASSIFIED

UNCLASSIFIED

~~SECRET~~

~~SECRET~~

UNCLASSIFIED

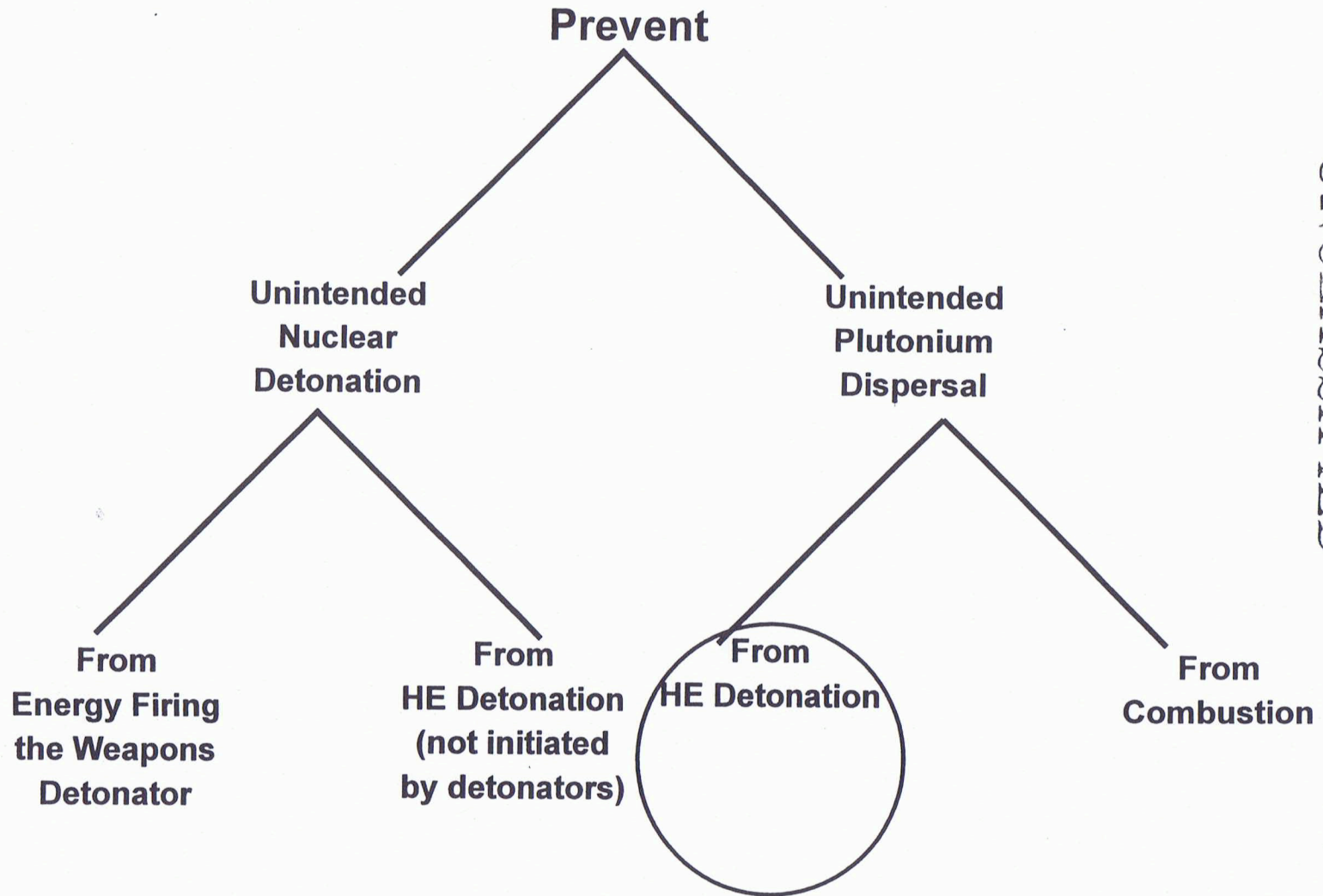

UNCLASSIFIED

~~SECRET~~

~~SECRET~~

UNCLASSIFIED

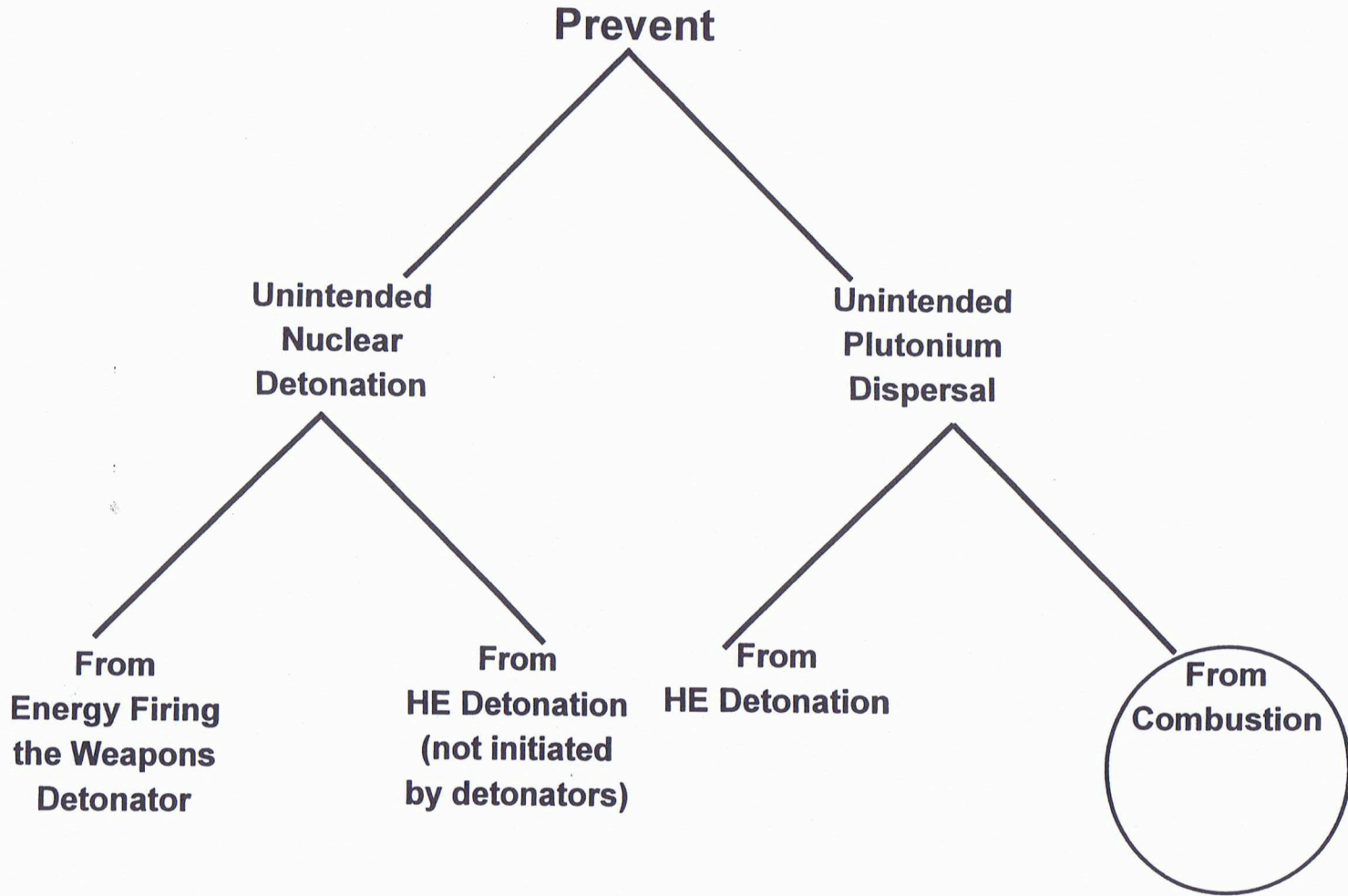

UNCLASSIFIED

~~SECRET~~

# **SURVEY OF WEAPONS DEVELOPMENT AND TECHNOLOGY**

**WR708**

**SESSION VIII**

- **PROTECTION OF NUCLEAR WEAPONS**
  - **ACCESS CONTROL MEASURES**
  - **USE CONTROL MEASURES**

~~SECRET~~

UNCLASSIFIED

UNCLASSIFIED

~~SECRET~~

# Layered Positive Measures to Assure Against Unauthorized Use

The Adversary: Humans or Accidents

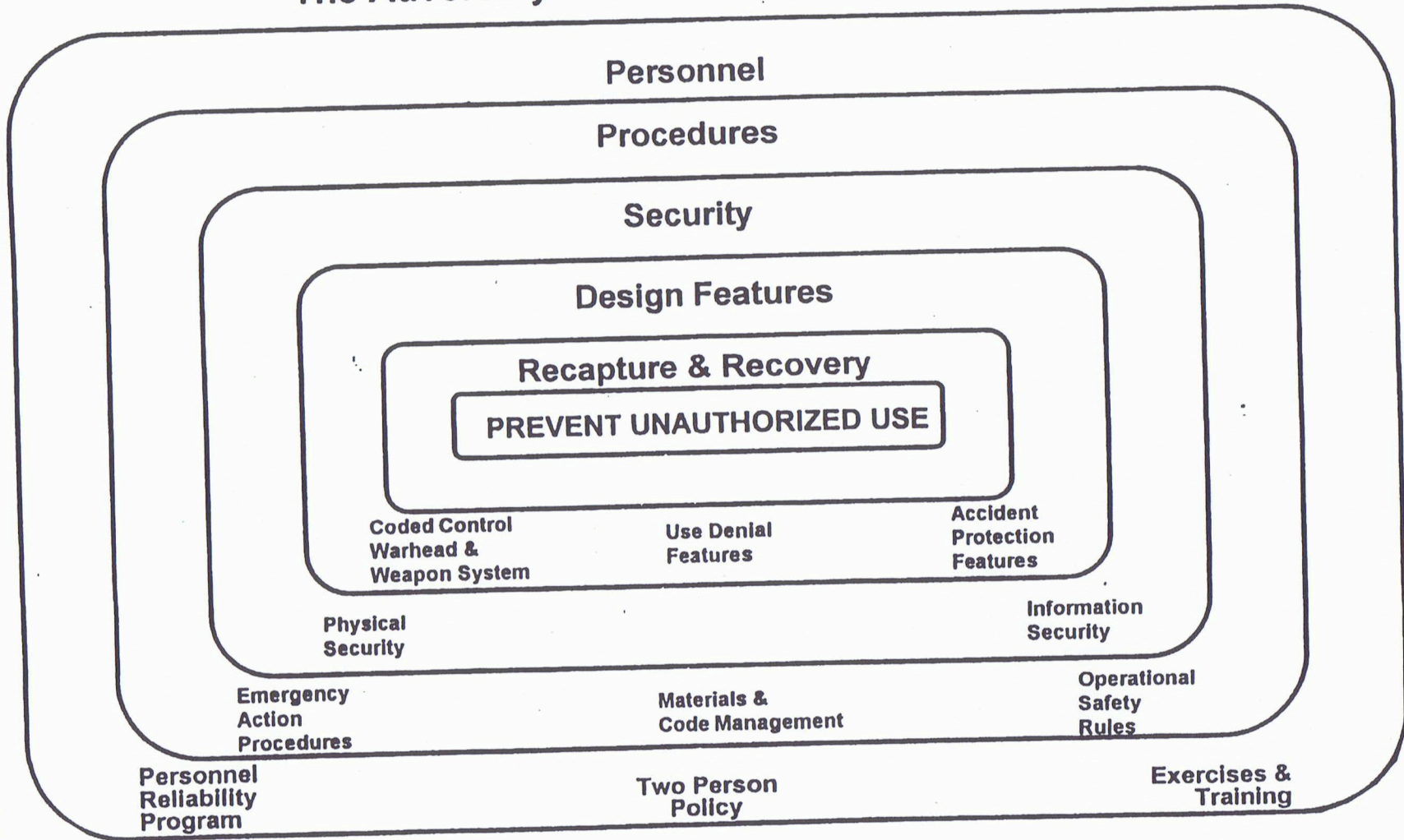

~~SECRET~~  
UNCLASSIFIED

~~SECRET~~  
UNCLASSIFIED



## **THE NUCLEAR WEAPONS ACCESS CONTROL AND USE CONTROL PROGRAMS TRY TO:**

---

- **Prevent unauthorized access to a nuclear weapon**
- **Prevent loss of custody of a nuclear weapon**
- **Prevent an intended (but unauthorized) nuclear explosion**
- **Prevent an intended (but unauthorized) dispersion of SNM**

**AND...**

~~SECRET~~

UNCLASSIFIED

UNCLASSIFIED

~~SECRET~~

**{ ACCESS CONTROL**

**NUCLEAR WEAPON  
USE CONTROL**

**AVOID  
NUCLEAR DETONATION**

**AVOID  
RADIOACTIVE MATERIAL DISPERSAL**

**REVERSIBLE  
PAL**

**IRREVERSIBLE  
DISABLEMENT**

**INTERNAL MEANS  
IHE**

**EXTERNAL MEANS  
ARMORED  
BLANKET**

~~SECRET~~

UNCLASSIFIED

UNCLASSIFIED

~~SECRET~~

~~SECRET~~

UNCLASSIFIED

ACCESS CONTROL (TO THE WEAPON) IS ANALOGOUS TO ACCIDENT PREVENTION - IF NO UNAUTHORIZED ACCESS (ACCIDENT) OCCURS, THERE IS LESS POTENTIAL FOR A PROBLEM.

HOWEVER, USE CONTROL FEATURES STILL ASSUME SOME LEVEL OF ACCESS CONTROL EXISTS OR CAN BE REESTABLISHED.

~~SECRET~~

UNCLASSIFIED

## ***ENVIRONMENTAL SENSING DEVICES (ESDs)***

---

**An open switch in the prearming circuits.**

**It is closed after sensing an environment experienced by the weapon system when enroute to the target.**

UNCLASSIFIED

~~SECRET~~

UNCLASSIFIED

~~SECRET~~

# ***INTENDED USE AND NON-INTENDED USE MODE OPERATION***

---

- **Intended Use Mode**

- **Use of the warhead, weapon and weapon system as designed to operate when used against a target.**

- **Non-Intended Use Mode**

- **Detonation “in place”; operation of weapon/weapon system in other than intended use mode.**

~~SECRET~~

UNCLASSIFIED

~~SECRET~~

UNCLASSIFIED

~~SECRET~~

UNCLASSIFIED

UNCLASSIFIED

~~SECRET~~

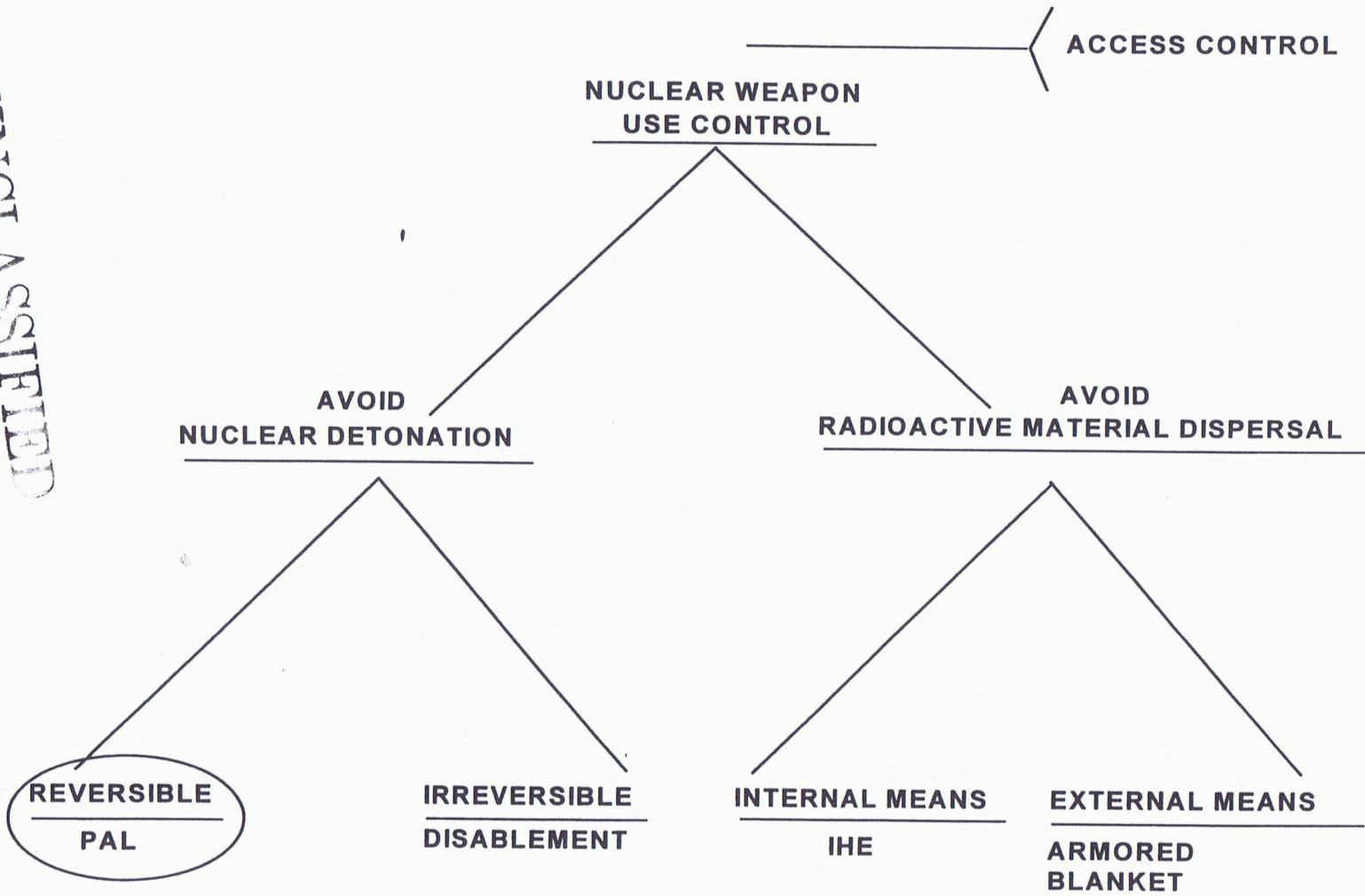

# PAL (Permissive Action Link)

A code controlled switch which interrupts the warhead's arming circuit

~~SECRET~~

UNCLASSIFIED

UNCLASSIFIED

~~SECRET~~

# EVOLUTION OF NUCLEAR WEAPON USE CONTROL

PAL

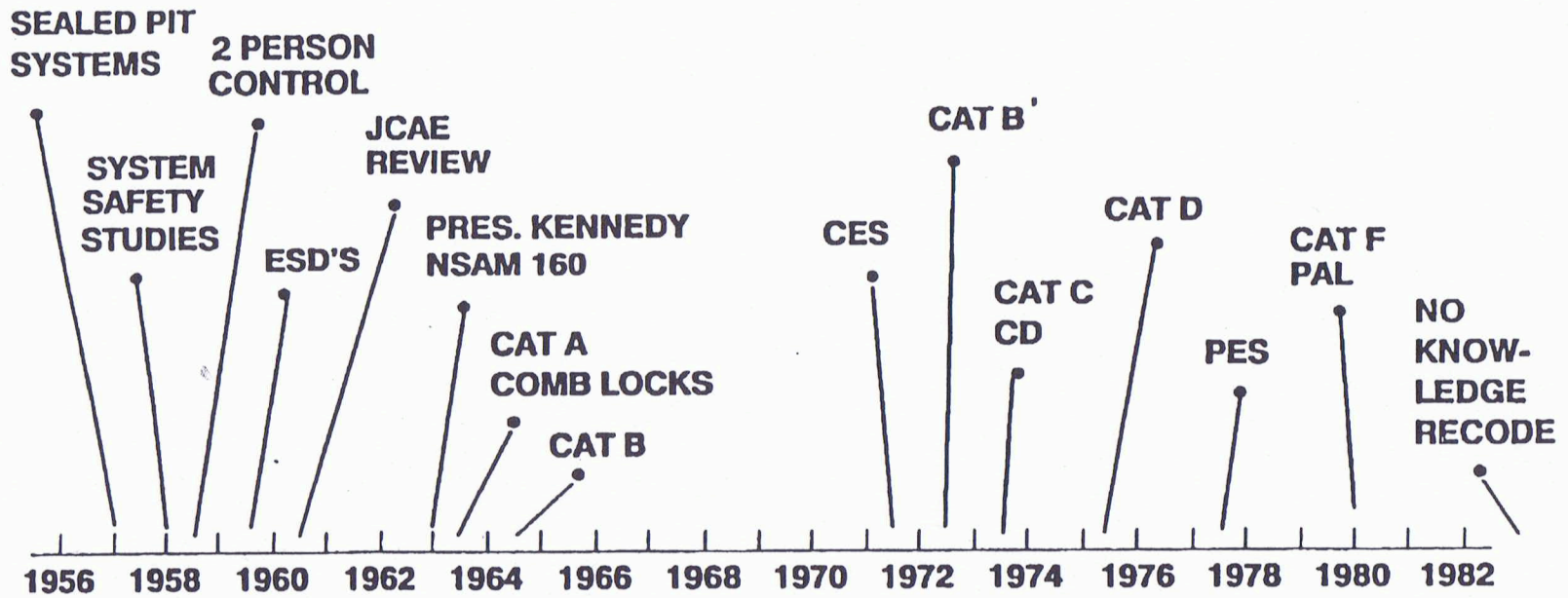

~~SECRET~~

UNCLASSIFIED

UNCLASSIFIED

~~SECRET~~



**UNCLASSIFIED**  
**SECRET**

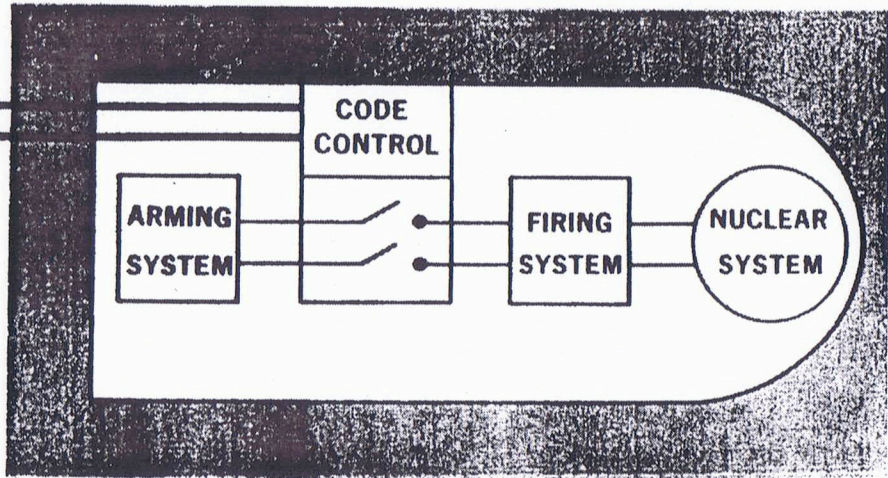
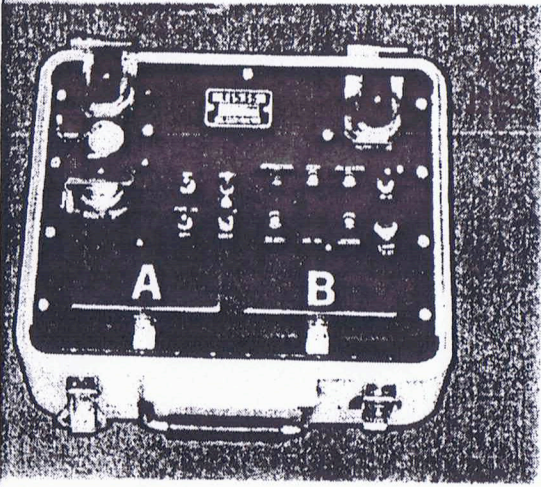
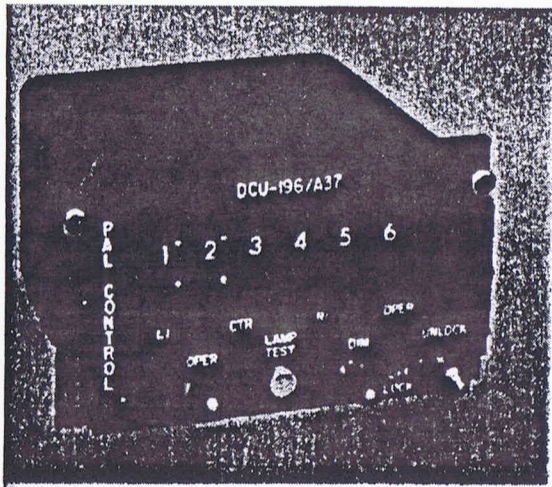

**PERMISSIVE ACTION LINK**

**SECRET**  
**UNCLASSIFIED**

# PAL Code Management

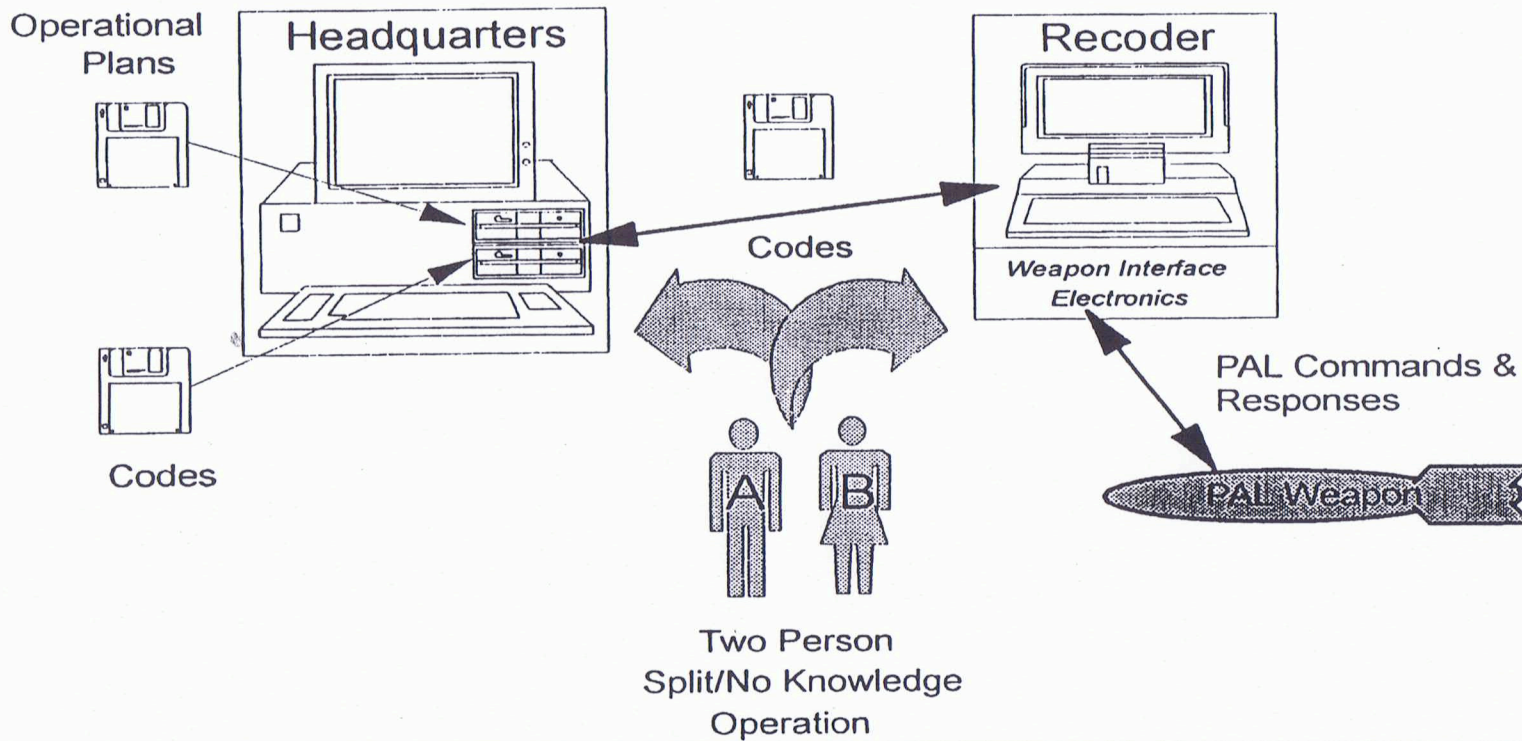

~~SECRET~~

UNCLASSIFIED

~~SECRET~~

UNCLASSIFIED

~~SECRET~~

UNCLASSIFIED

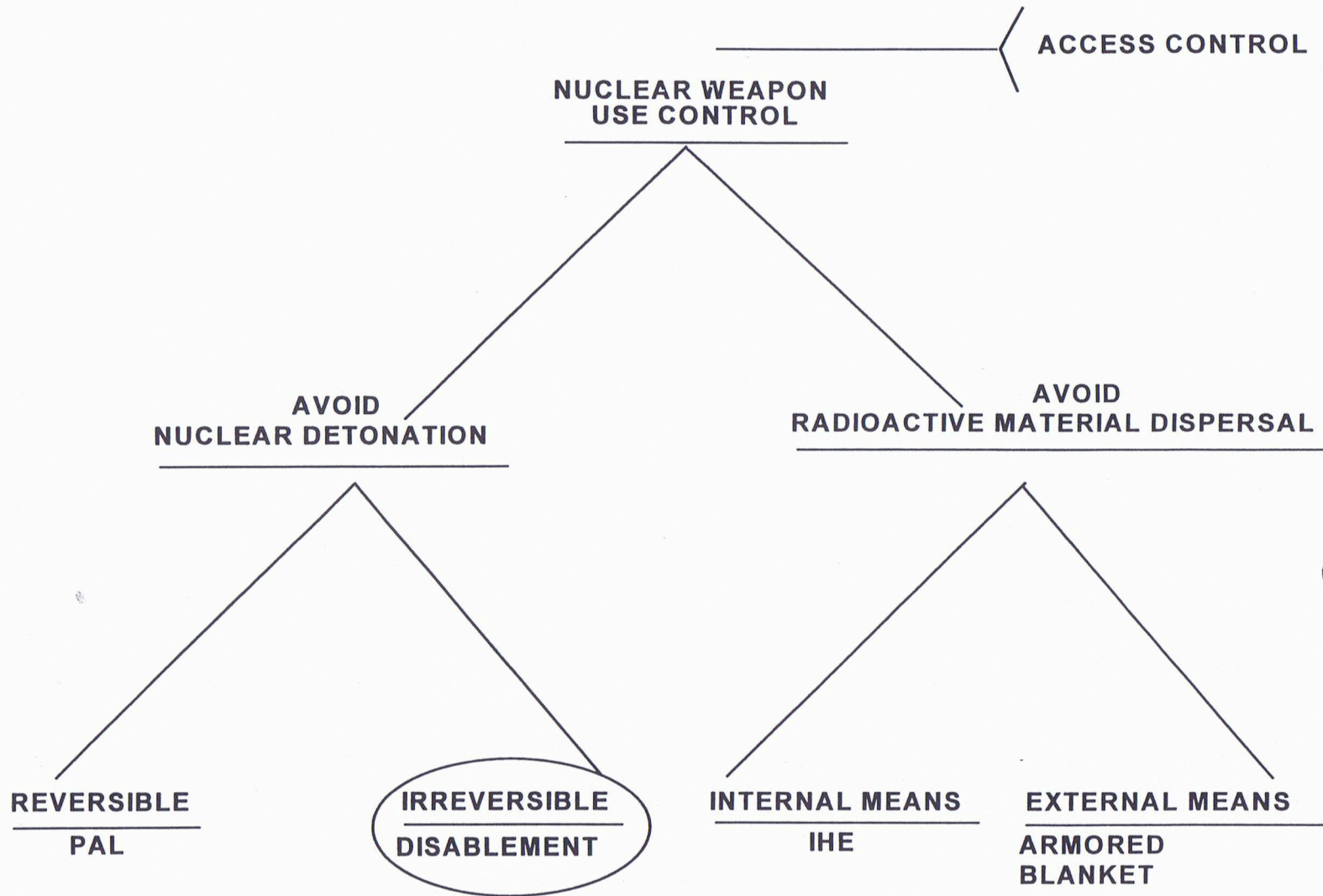

~~SECRET~~

UNCLASSIFIED

## *DISABLEMENT*

---

- When initiated, disables certain key nuclear detonation-essential components.
- Non-violent outside the weapon case.

~~SECRET~~

UNCLASSIFIED

~~SECRET~~

UNCLASSIFIED

# Warhead Use Control

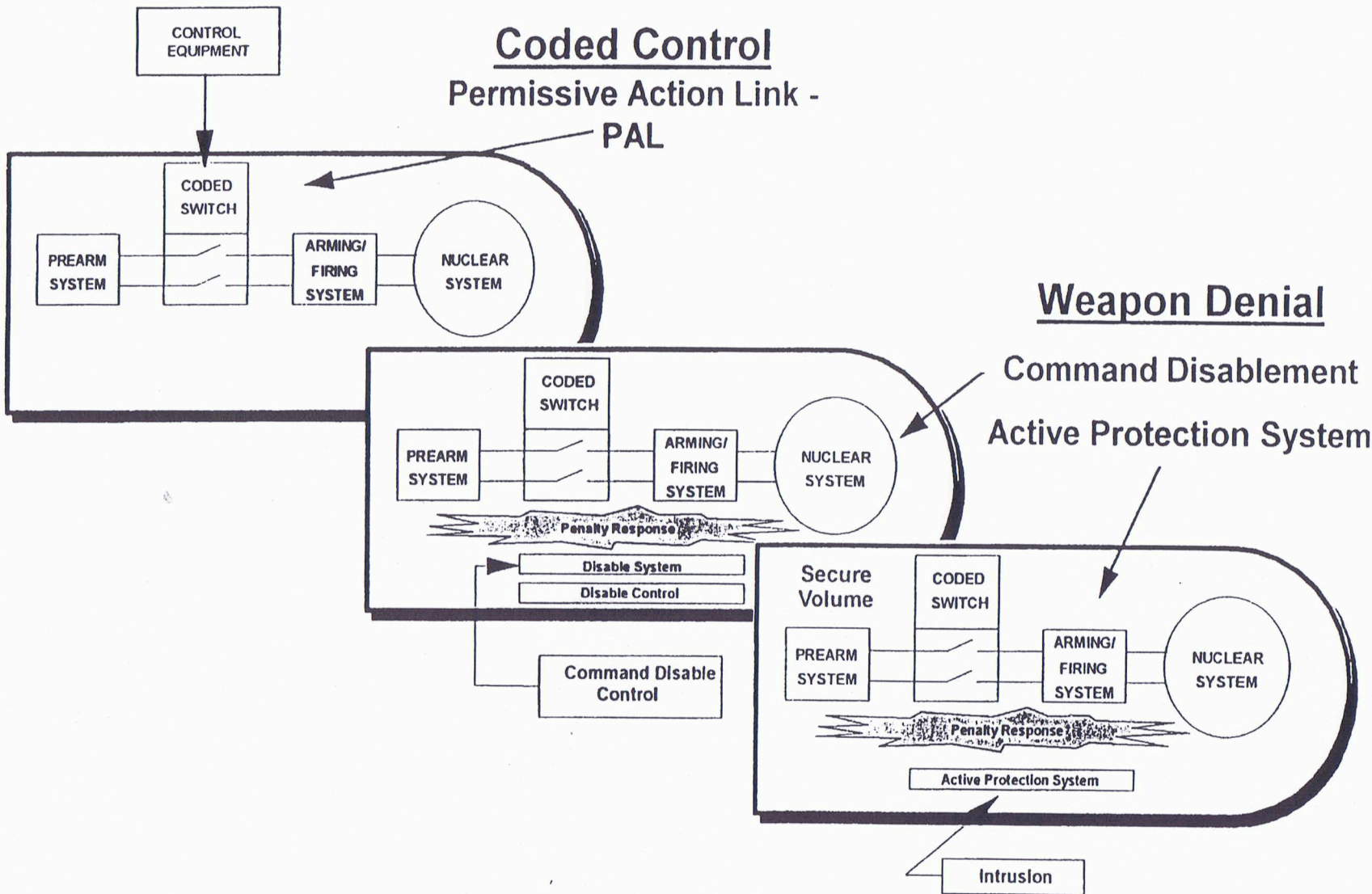

~~SECRET~~

UNCLASSIFIED

~~SECRET~~

UNCLASSIFIED

b (3)



~~SECRET~~

UNCLASSIFIED

~~SECRET~~

UNCLASSIFIED

UNCLASSIFIED

~~SECRET~~

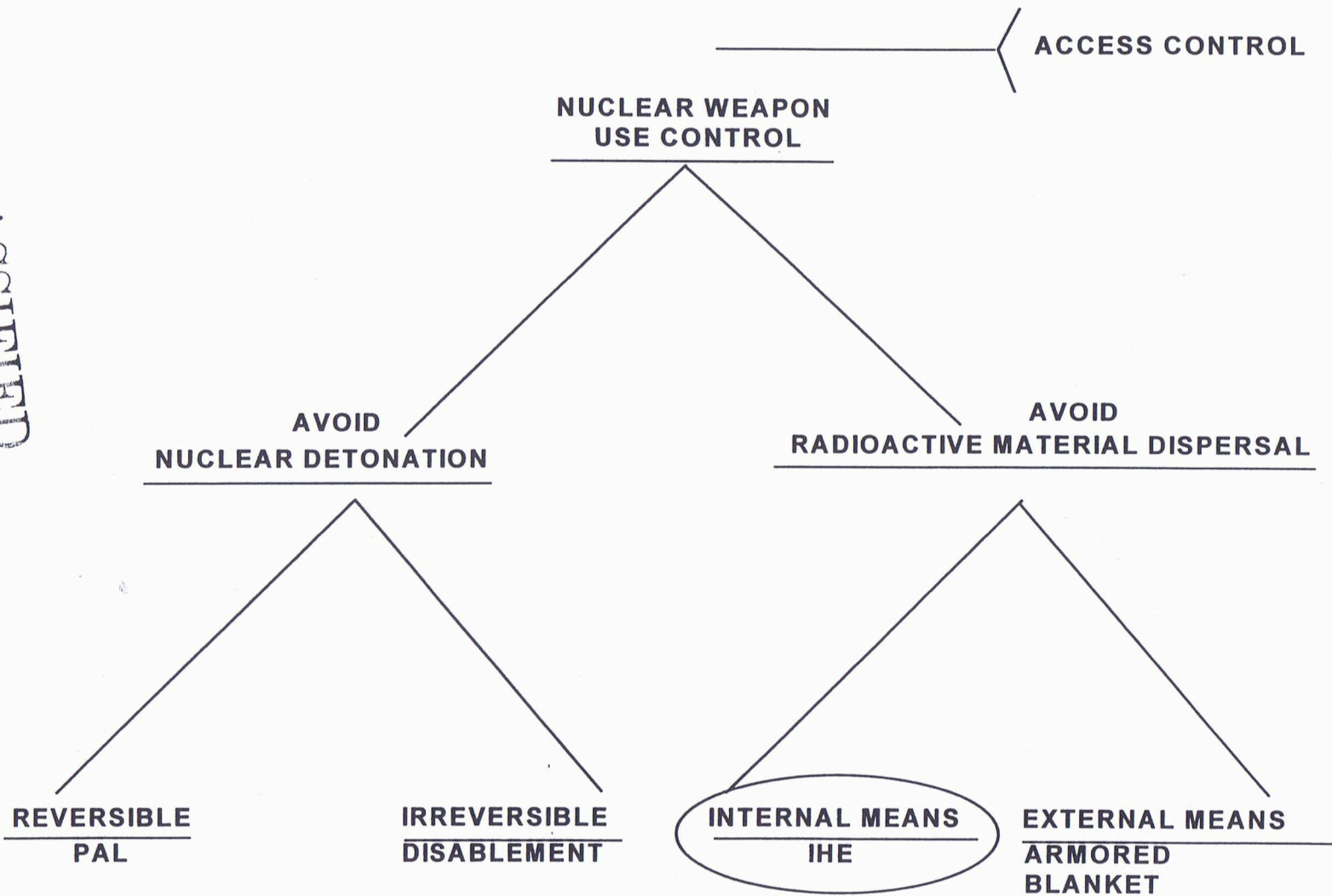

UNCLASSIFIED

~~SECRET~~

~~SECRET~~

UNCLASSIFIED

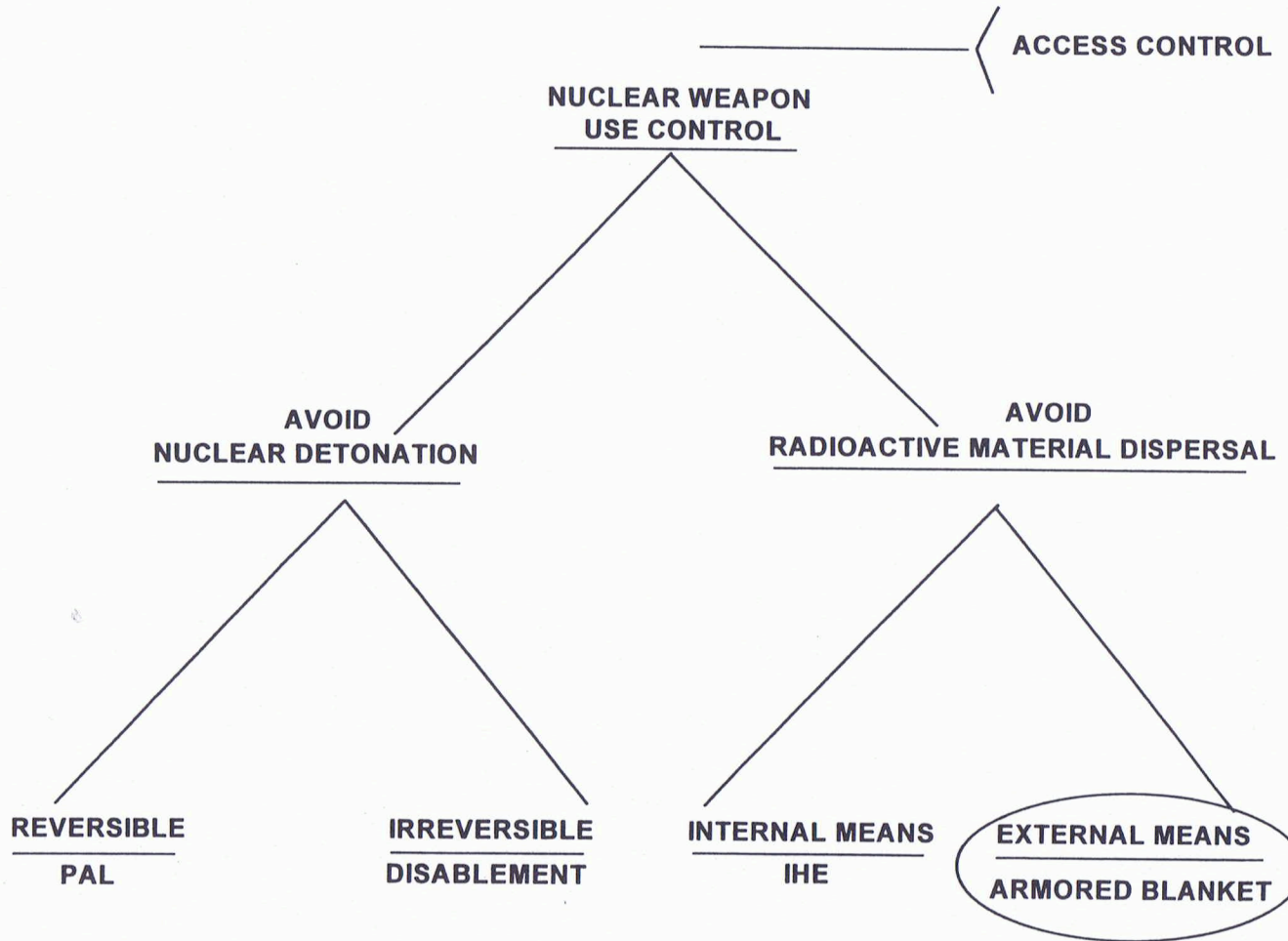

UNCLASSIFIED

~~SECRET~~



# **SURVEY OF WEAPONS DEVELOPMENT AND TECHNOLOGY**

**WR708**

**SESSION IX**

**AIRCRAFT WEAPON SYSTEMS**

- **WEAPON SYSTEMS**
- **REQUIREMENTS**
- **NUCLEAR WEAPONS SYSTEMS FOR ENDURING STOCKPILE**
- **AIRCRAFT INTERFACE**

~~SECRET~~

UNCLASSIFIED

UNCLASSIFIED

~~SECRET~~

UNCLASSIFIED

~~SECRET~~

## SANDIA NATIONAL LABS AIRCRAFT COMPATIBILITY DEPARTMENT

- Our charter is to ensure the Department of Energy that a capability exists between US nuclear weapons and the aircraft they are carried on throughout their life in the inventory.
- Our department was established in the early 1960's.
- We work with the military, aircraft contractor, and Sandia's weapon departments in the design of the aircraft/weapon interface.
- We define the requirements the military and contractor must comply with before final design approval can be granted.
- We conduct a wide range of electrical and mechanical tests to verify a capability exists.

UNCLASSIFIED

~~SECRET~~

## An Overview of the Evolution of Aircraft Monitor and Control (AMAC) Systems

- The AMAC acronym was created to describe the dedicated “black boxes” that monitor and control nuclear weapons.
- From 1945 to 1961, no standard weapon interface existed. Early bomb technology drove the design of the AMAC Systems.
- Little Boy (B1) and Fat Man (B2) were controlled by an AMAC known as a Flight Test Box (FTB). The FTB could measure battery voltages, turn on radars, and could verify certain components had not failed. Two manually inserted arming plugs were used to arm the weapons prior to pressurization of the cockpit at 8000ft.
- Manually inserted arming plugs were also used on the B3 (production Fat Man) and B4-0 bombs.
- 1950 saw the first bomb (B5) to incorporate a cockpit controlled inflight insertion (IFI) mechanism for enhanced nuclear safety. This device was the forerunner of the Ready/Safe switch, and it required a new AMAC to control this bomb feature.

UNCLASSIFIED

~~SECRET~~

UNCLASSIFIED

~~SECRET~~

## An Overview of the Evolution of Aircraft Monitor and Control (AMAC) Systems

- 1952 saw the first fighter-carried bomb (B7). It had an AMAC controlled retractable fin for ground clearance.
- By 1952 there were three AMAC systems for bomber aircraft and one for fighter aircraft.
- In the late '40s and early '50s AMAC systems were built around the specific needs for the bombs, not the aircraft.
- In 1954 Sandia started a program to standardize AMAC functions for new weapons under development.
- The result of this effort resulted in the T249 AMAC for bomber and fighter aircraft usage.

~~SECRET~~

UNCLASSIFIED

UNCLASSIFIED

~~SECRET~~

## An Overview of the Evolution of Aircraft Monitor and Control (AMAC) Systems

- New bombs designed during the mid to late '50s were made compatible with the T249 rather than building a unique AMAC for a specific bomb.
- AMAC design specifications, defined jointly by the DOE and DoD, first appeared in December 1961.
- AMAC specifications such as Bomber System A, Fighter System A & B, and Aero 6B were the forerunners of today's AMAC systems.
- Today's nuclear-capable aircraft, with the exception of the B-52 ALCM/ACM AMAC Systems, have what is known as a System 1 AMAC interface.
- The System 1 specification first appeared in September 1963.

UNCLASSIFIED

~~SECRET~~

UNCLASSIFIED

~~SECRET~~

## System 1 Offered Many Improved Features in Safety and Compatibility

- A current-limited Monitor State allowing weapon status to be checked without applying Safe power.
- Dedicated weapon status monitor pins for Safe, Arm, Permissive Action Link (PAL), and Weapon Present ID.
-  (3)
- Category (CAT) B PAL [6/63] and CAT D PAL [8/75] enhanced weapon security.
- Unique Signal Generator (USG) [8/75] enhanced weapon safety in abnormal environments.
- Command Disable (CD) [10/81] provided the ability to render a weapon useless from the cockpit.

UNCLASSIFIED

~~SECRET~~

UNCLASSIFIED

~~SECRET~~

## Conclusion

- All aircraft nuclear weapon interfaces built to date have been analog.
- AMAC systems have transitioned from separate to integrated designs.
- A System 2 AMAC specification, based on MIL-STD-1760, exists that defines a digital interface for possible use in future nuclear weapons.
- The number of nuclear capable aircraft has decreased considerably in recent years.

~~SECRET~~

UNCLASSIFIED

UNCLASSIFIED

~~SECRET~~

b (3)

~~SECRET~~

UNCLASSIFIED

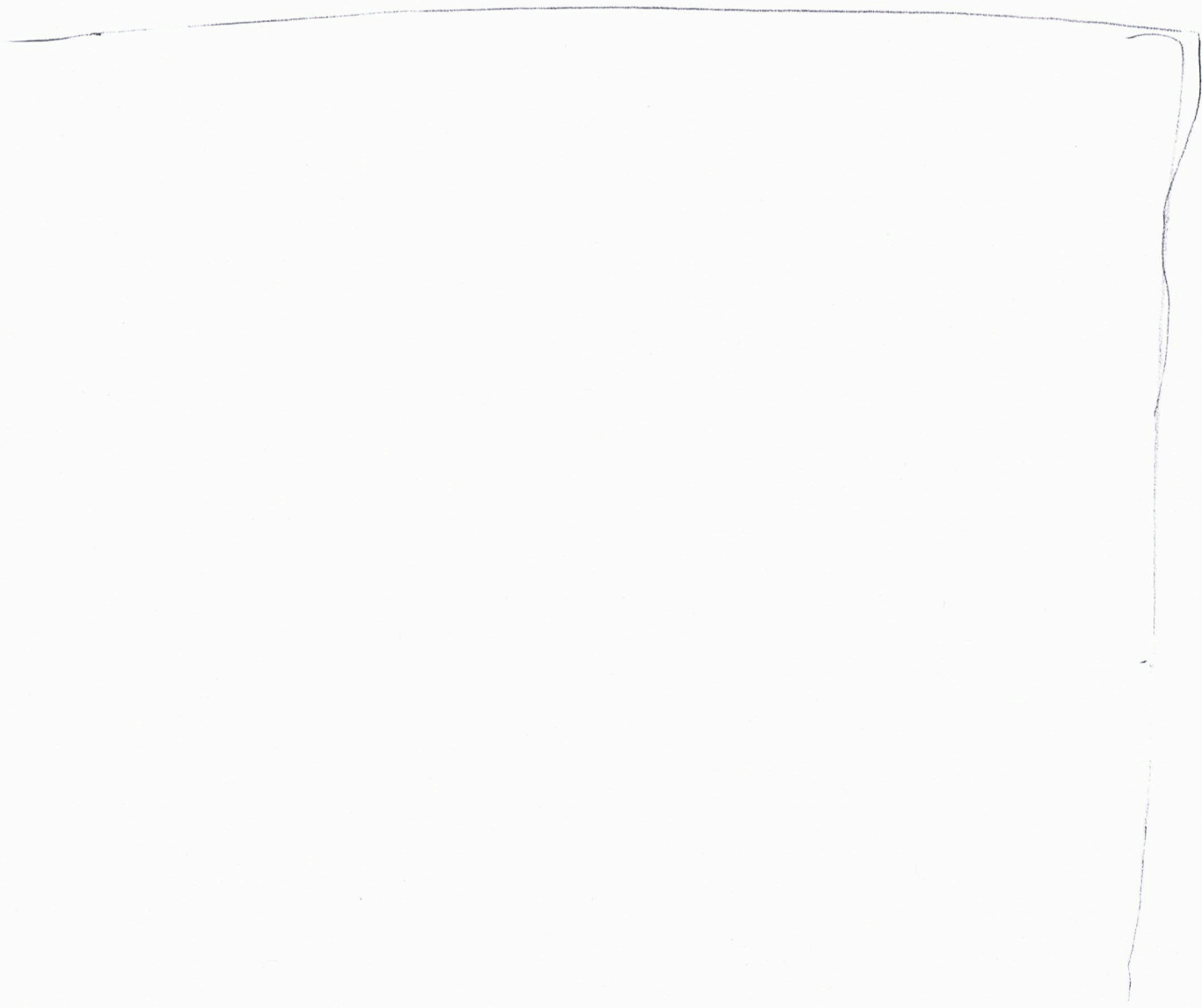

~~SECRET~~

UNCLASSIFIED



~~SECRET~~

UNCLASSIFIED

b(3)

UNCLASSIFIED

~~SECRET~~

~~SECRET~~

UNCLASSIFIED

THIS PAGE INTENTIONALLY LEFT BLANK

UNCLASSIFIED

~~SECRET~~

# SURVEY OF WEAPONS DEVELOPMENT AND TECHNOLOGY

WR708

SESSION X

- Nuclear Weapons Dismantlement

~~SECRET~~

UNCLASSIFIED

~~SECRET~~

UNCLASSIFIED

# Dismantlement Topics

- **Process**
- **Magnitude**
- **DOE/Labs Organization**
- **Technology Applications**
- **Laboratories Increased Presence at Pantex**
- **Lab-to-Lab Interchanges with Russians**

~~SECRET~~

UNCLASSIFIED

UNCLASSIFIED

~~SECRET~~

UNCLASSIFIED

~~SECRET~~

MARGULIES  
© 1991 THE RECORD  
NEW JERSEY

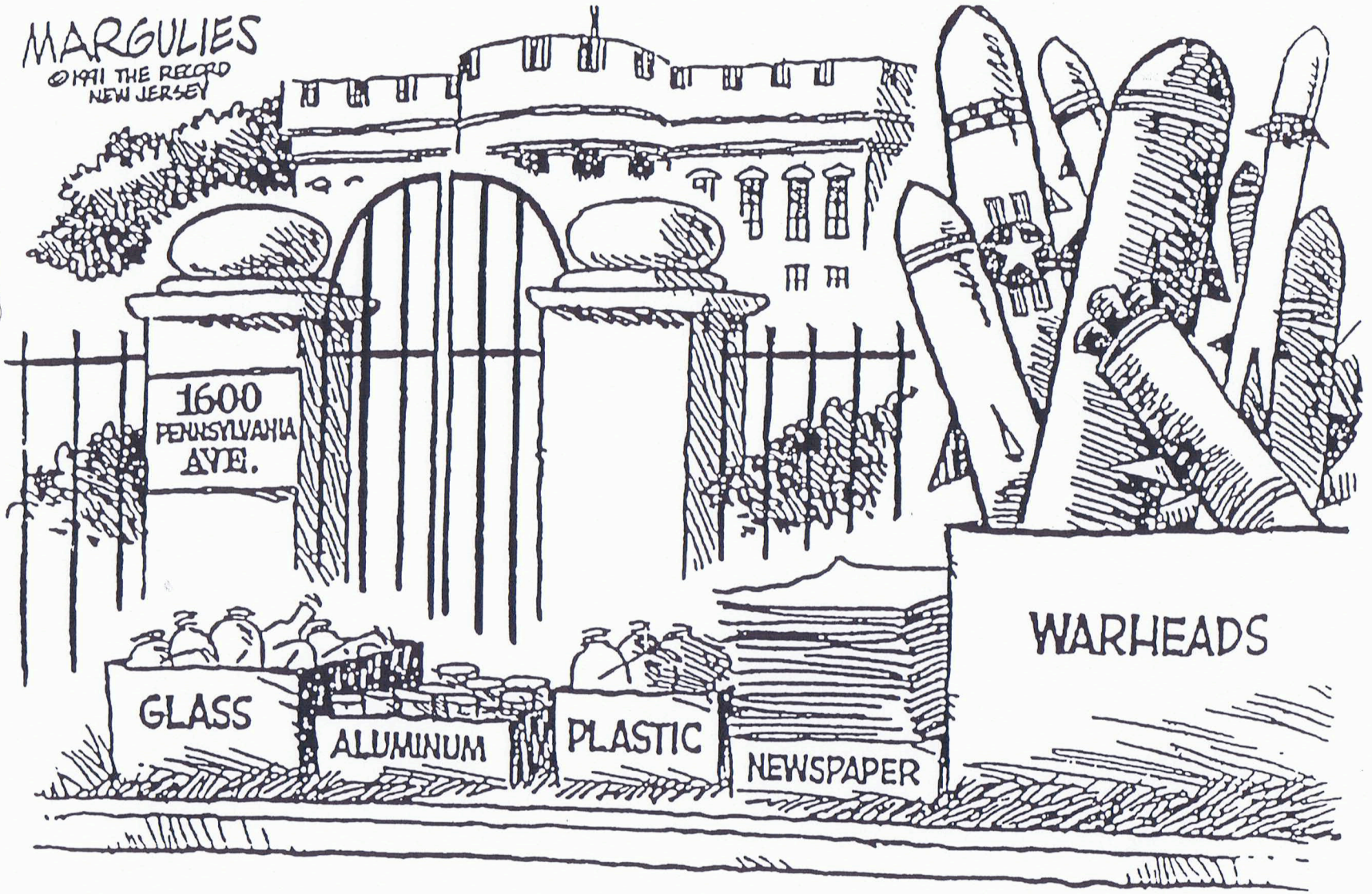

~~SECRET~~

UNCLASSIFIED

# Nuclear Stockpile Dismantlement Process

UNCLASSIFIED

DoD Custody

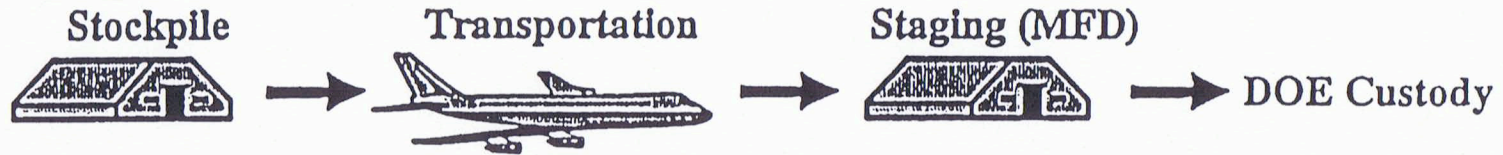

DOE Custody

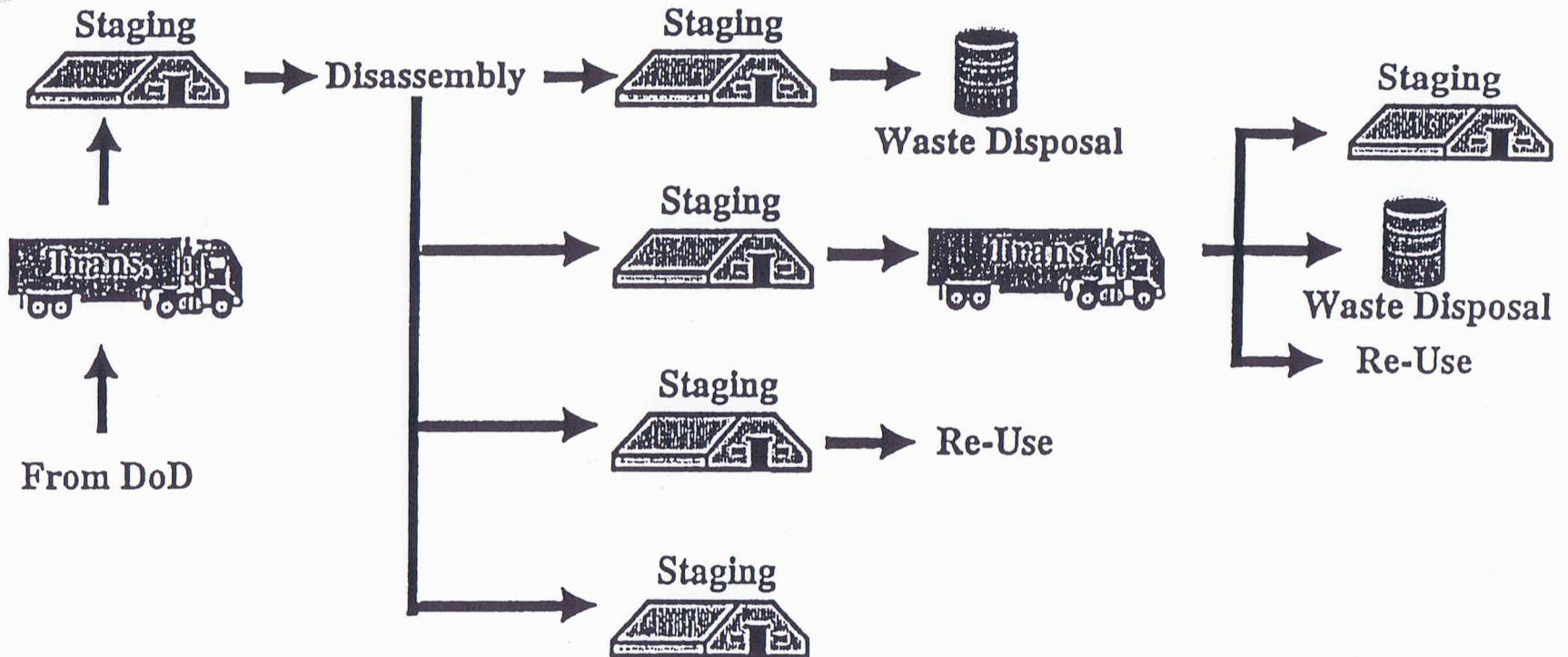

SECRET

SECRET

UNCLASSIFIED

~~SECRET~~

UNCLASSIFIED

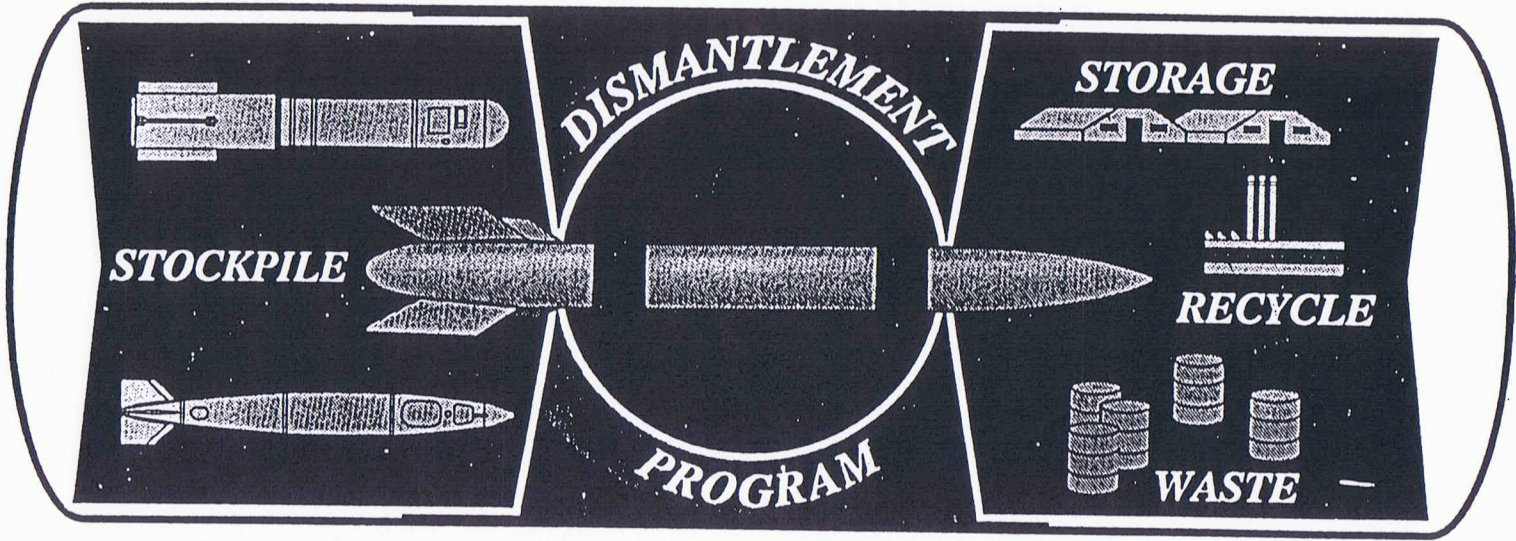

UNCLASSIFIED

~~SECRET~~

# PANTEX PLANT LOCATION

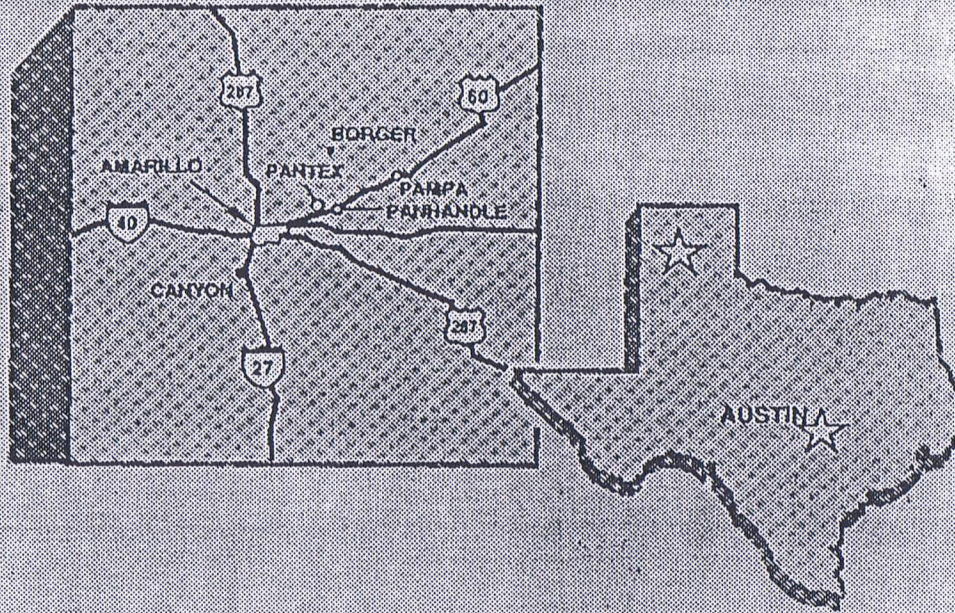

~~SECRET~~

UNCLASSIFIED

UNCLASSIFIED

~~SECRET~~



# Pantex Organization Responsibilities

- **Government owned facility**
- **DOE Amarillo Area Office (reports to AL)**
  - Administers operating contract
- **Mason & Hanger - Silas Mason Co., Inc.**
  - Management and operating (M&O) contractor
- **Battelle Memorial Institute**
  - Subcontractor for Environment, Safety, and Health (ES&H)
- **Sandia National Laboratories**
  - Operates Weapons Evaluation Test Laboratory (WETL)

~~SECRET~~

UNCLASSIFIED

~~SECRET~~  
UNCLASSIFIED

# Pantex Plant Statistics

- **\$190M operating budget**
- **2945 employees**
  - **2600 M&H**
  - **250 Battelle**
  - **78 AAO**
  - **17 Sandia**
- **16,000 acres**
- **2.5M sq. ft. buildings (425 units)**

~~SECRET~~

UNCLASSIFIED

UNCLASSIFIED

~~SECRET~~

# Size of Dismantlement

- Pantex capability approximately 2000 per year
- Backlog of weapons
- Retirements continue
- [REDACTED]
- Taper off to support retirements as they occur

~~SECRET~~

UNCLASSIFIED

~~SECRET~~

UNCLASSIFIED

# Stockpile (P&PD 93-2)

**SRD Viewgraph**

**Shows  
Stockpile, Reserves, and Retiring**

**(Not included herein)**

~~SECRET~~  
UNCLASSIFIED

UNCLASSIFIED  
~~SECRET~~

Department of Energy  
Executive Management Team for Dismantlement

- **Formed by DASMA**
- **Covers all aspects of retirement, return, disassembly, waste characterization, and disposal**
- **Develop integrated departmental positions and strategies for dismantlement**
  - **Internal to DOE**
  - **With DoD**
- **Membership with DoD**
  - **DOE/AL, DOE/HQ, LANL, SNL, LLNL**
  - **Reports to DASMA weapons panel**

~~SECRET~~

UNCLASSIFIED

~~SECRET~~  
UNCLASSIFIED

Department of Energy  
Executive Management for Dismantlement

**DOE/AL**

**Deborah Monette Chair**

**DOE/HQ**

**Karen Lombardo**

**Exec Sec**

**LANL**

**Mike Kelly**

**LLNL**

**Jerry Dow**

**SNL**

**Paul Longmire**

~~SECRET~~

UNCLASSIFIED

UNCLASSIFIED

~~SECRET~~

# Dismantlement Priorities

- **Weapons Shipment Planning**
  - Priority based on risk analysis
- **Material Destination - Disposal**
  - Identification
  - Characterization
  - Obey Laws
- **Storage of SNM**
  - Keep at Pantex until better solution found

~~SECRET~~

UNCLASSIFIED

UNCLASSIFIED

~~SECRET~~

# DISMANTLEMENT PRIORITIZATION PROCESS

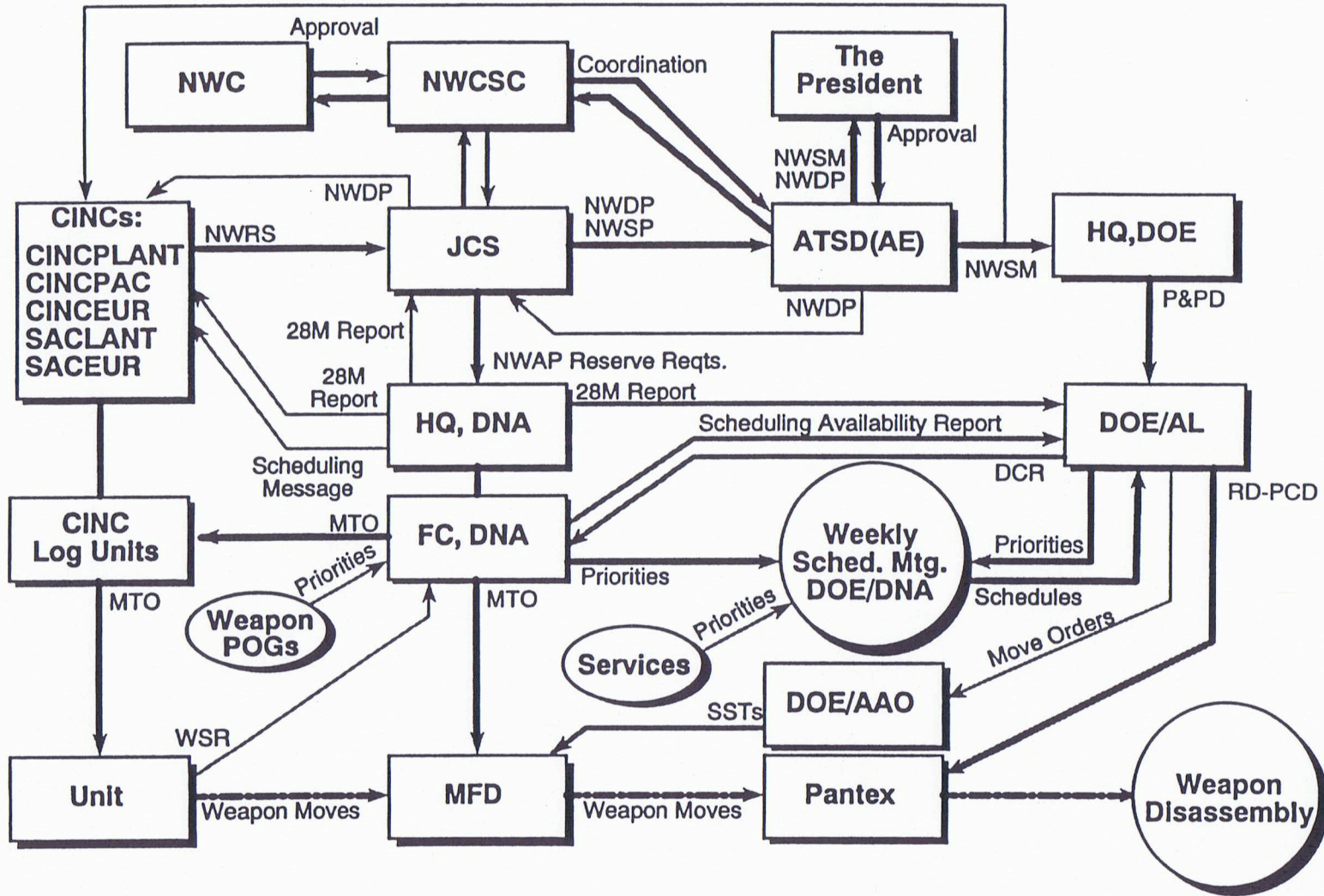

~~SECRET~~

UNCLASSIFIED

UNCLASSIFIED

~~SECRET~~



## Dismantlement Prioritization Working Group

- Joint DOE/DoD group chaired by Sandia
- Initial phase identified and ranked weapons based on weapon features
- Dismantlement process from initial retirements to disposal was defined
- Influences that determine priorities were identified
- DOE issues such as staging requirements and transportation assets were examined
- Software written to process data
- Group continues for information exchange and planning assistance

~~SECRET~~

UNCLASSIFIED

UNCLASSIFIED

~~SECRET~~

b (3)

~~SECRET~~ UNCLASSIFIED

~~SECRET~~ UNCLASSIFIED

# Information Systems

- **Developing database for material identification and characterization**
- **Compatible with each DOE design agency and production agency**
- **Allows Pantex to receive information electronically**
- **Allows each DA and PA to enter their desired data**
- **Replaces old scrapbook system at Pantex**

~~SECRET~~

UNCLASSIFIED

UNCLASSIFIED

~~SECRET~~

**DOE Dismantlement Policy**  
**Component Retention, Reuse, or Evaluation**

- **For each weapon in the dismantlement process, a laboratory study will be conducted to determine if any of the major assemblies, components, or their subcomponents should be:**
  - (1) Retained for reuse**
  - (2) Salvaged for their strategic or economic value**
  - (3) Retained for safety and use-control effectiveness evaluations**
  - (4) Evaluated to provide further statistical data regarding the quality and reliability of comparable hardware in the enduring stockpile**

~~SECRET~~

UNCLASSIFIED

UNCLASSIFIED

~~SECRET~~

## Non-Nuclear Hardware From Dismantled Weapons

- All hardware scheduled for disposal unless otherwise requested
- Sandia plans to request designated hardware to be returned for evaluation
- Possible storage of Sandia hardware for future use when a direct replacement in the enduring stockpile, e.g., mods of B61
- Los Alamos plans no storage of hardware except for Detonators
- LLNL plans no storage of hardware
- Evaluation units for LANL and LLNL will be requested as needed

~~SECRET~~

UNCLASSIFIED

UNCLASSIFIED

~~SECRET~~

## Component Commonality Matrix, A Few Examples

Dismantled Weapons	Enduring Stockpile			
	B61	W78	B83	W76,W80,W87,W80
B57	Solder Conn		Para chute	
W68	Trig Ckt	Trig Ckt	Trig Ckt	
W70	LAC	LAC N.G.	LAC	

W56, B61-0,  
W69,  
W71, W79

UNCLASSIFIED

~~SECRET~~

UNCLASSIFIED

~~SECRET~~

## DOE Dismantlement Policy

### Component Retention, Reuse, or Evaluation

- For each weapon in the dismantlement process, a laboratory study will be conducted to determine if any of the major assemblies, components, or their subcomponents should be:
  - (1) Retained for reuse
  - (2) Salvaged for their strategic or economic value
  - (3) Retained for safety and use-control effectiveness evaluations
  - (4) Evaluated to provide further statistical data regarding the quality and reliability of comparable hardware in the enduring stockpile

UNCLASSIFIED  
~~SECRET~~

~~SECRET~~  
UNCLASSIFIED

## DSD Manual

The Demilitarization and Sanitization for Disposition (DSD) Manual defines the process to be utilized in the nuclear weapons complex for applying the general guidelines to define and document a demilitarization, sanitization, and/or render-safe process. The process description covers the use of the Demilitarization/Sanitization Table, the Weapon Component Data Sheets, and the issue resolution process.

~~SECRET~~

UNCLASSIFIED

UNCLASSIFIED

~~SECRET~~



UNCLASSIFIED

~~SECRET~~

# MMSC Demilitarization/Sanitization

<i>Part Nomenclature</i>	<i>Demilitarization</i>	<i>Sanitization</i>	<i>Render Safe</i>	<i>Method</i>
Actuators/Squibs	Yes	No/Yes	Yes	Fire or explosive disposal (some use control items may require sanitization)
Connectors	No	No/Yes	No	None (unless rad hardening potting used, then sanitization required)
Detonators and Cable Assemblies	Yes	Yes	Yes	Fire - shred cable/crush header or explosive disposal (protect# info.)
Foams, cushions compression pads, desiccants, plastics, etc.	No	No/Yes	No	None (shred, melt, or burn if show classified contours or shock mitigation info.)
Mechanical Hardware (O-rings, brackets, bolts, cover plates, rings, etc.)	No	No	No	None (part identifier removed if association makes classified)
Neutron Generator, Electronic	Yes	Yes	Yes	Crush (remove rad tube?)
Neutron Generator, Explosive	Yes	Yes	Yes	Fire (mixed waste) or timer driver to explosive disposal/tube to rad waste
Reservoir	Yes	Yes	Yes	Bury (remove rad material if appropriate)
Thermal Battery	Yes	No	Yes	Fire
Timers	No	No	No/Yes	None (fire - remove explosives if appropriate)
Use Control, PAL, CD Hardware	Yes	Yes	Yes	Expend, crush, shred, bury as appropriate

~~SECRET~~ UNCLASSIFIED

# Nuclear Material Storage/Disposal

- All pits put in interim storage
- Yet to determine ultimate fate of plutonium
- **Secondaries under study**
  - Portion to be stored
  - Portion to be disassembled into basic materials

UNCLASSIFIED

~~SECRET~~

UNCLASSIFIED

~~SECRET~~

# SNM Storage Problem

- **Present Storage Magazines**
  - Containers stored vertically in planar array
  - At present rate magazines full in March 1994
- **Proposed Changes**
  - Containers stored horizontally in multi-layers
  - Activate additional magazines
  - Problem Created
    - High radiation levels
    - Worker could receive yearly allowable dose in approximately one day
- **Solution**
  - Use machines to load, retrieve, and inventory

~~SECRET~~

UNCLASSIFIED

UNCLASSIFIED

~~SECRET~~

# Project Stage Right Storage

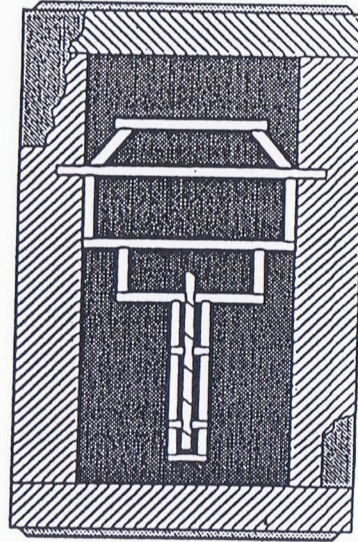
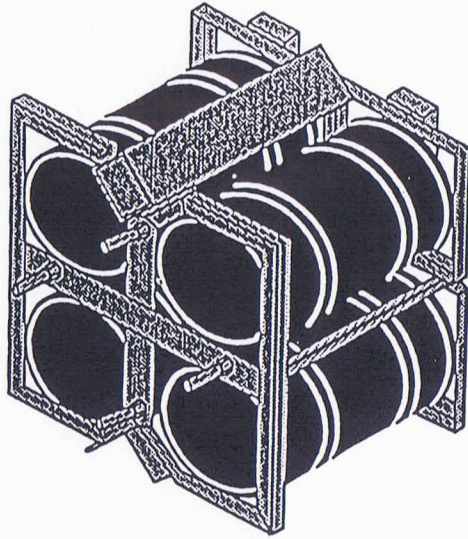

~~SECRET~~  
UNCLASSIFIED

~~SECRET~~  
UNCLASSIFIED

# External Oversight

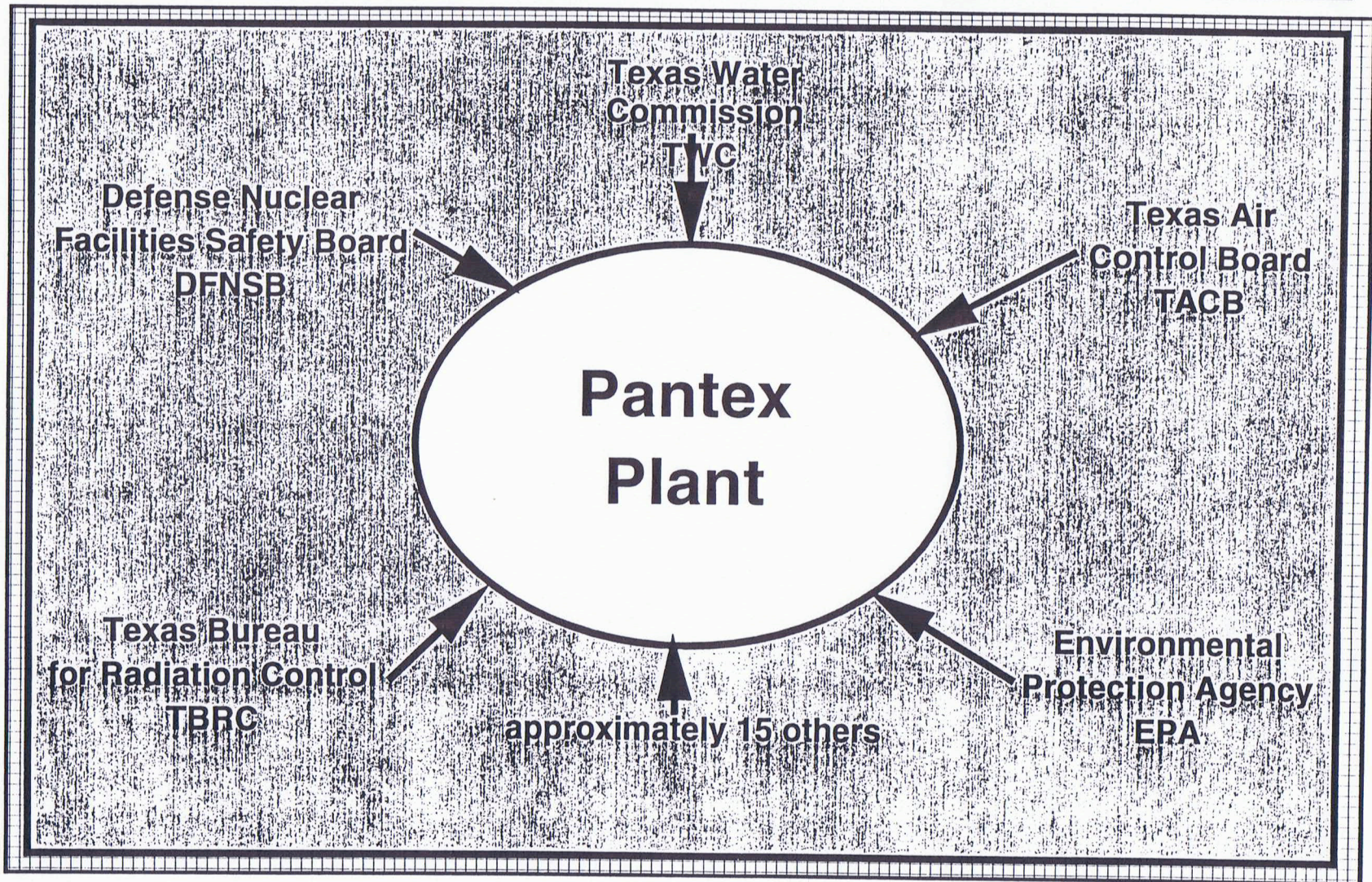

UNCLASSIFIED  
~~SECRET~~

UNCLASSIFIED  
~~SECRET~~

# Sandia/Pantex Robotics

- **Weighing and Leak Checking System (WALS)**
- **Disassembly**
- **System Studies**

~~SECRET~~

UNCLASSIFIED

UNCLASSIFIED

~~SECRET~~

## Quality Evaluation for Dismantlement (QED)

- **Concept originated in DOE Policy**
  - **Generated by EMTD and approved by DP-20**
- **Labs assess dismantlement process**
- **Level 1-Weapon receipt through disassembly**
- **Level 2-Subassembly and component preparation for disposal**
- **Joint Lab team effort to provide the best technical advice**
- **M&H-Battelle retains overall responsibility**
- **Defense Nuclear Facility Safety Board values to process**
  
- **Level 1 evaluations performed on W48, B57, W68, and W70**
- **Official Laboratory Quality Releases in December 1992**
- **Planning for Level 2 underway**

~~SECRET~~

UNCLASSIFIED

UNCLASSIFIED

~~SECRET~~

## Lead Lab Approach

- **Preserve technology at Laboratories**
- **Utilize limited resources supporting process and manufacturing development**
- **Maintain Laboratories' unique technical competence**
- **Enhance Laboratories' capability to provide limited backup**
- **Facilitate further enhancement of technology transfer**
- **Increases scope of Laboratories' functions and responsibilities**
- **Role and relationships of Labs and Production agencies will change**
- **Lead Lab responsible for maintaining technical excellence in production technology**
  - "Cradle to grave"

~~SECRET~~

UNCLASSIFIED

UNCLASSIFIED

~~SECRET~~



# Pantex Lead Lab Assignments

- **Weapon assembly/disassembly**
  - Sandia, Paul Longmire
  - Nuclear subassembly
    - Los Alamos, Luis Salazar
- **High Explosives**
  - LLNL, Dick Hatfield
- **Responsible for developing and certifying processes at plants for Complex 21**
- **Follow-on to Technology Assessment and Selection Panel (TASP)--currently in operation**

~~SECRET~~

UNCLASSIFIED

~~SECRET~~

UNCLASSIFIED

## Tri-Lab Project Office

- 10/92 letter from Bruce Twining, MGR DOE/AL

*"Laboratories play a stronger, more direct role, and well-defined role in nuclear operations, wherever they occur, with a first-step emphasis on Pantex operation"*

*"Establish a Joint Laboratory Technical Support Office"*

- Tri-Lab Project Office in operation
  - Ribbon cutting ceremony Sept. 29, 1993
  - Four offices for each Lab
  - Three on-site residents from LLNL--Two from LANL
  - One resident from SNL--one more in process
- Full office facilities, e.g., adm. support, repository

UNCLASSIFIED  
~~SECRET~~

UNCLASSIFIED

~~SECRET~~

## Coopertive Program between US and Russian Labs

- **Participants**
  - **US--Sandia, Los Alamos, and LLNL**
  - **Russia--Chelyabinsk and Arzamas-16**
- **Unclassified, non-sensitive information exchanges**
- **Four areas of activity**
  - **Risk assessment--Stan Spray**
  - **Transportation Surety--John Kane**
  - **Hazardous Materials--Paul Longmire**
  - **Communication and Translation--Patricia Newman**
  - **Hazardous materials includes handling, material ID, and waste management**

~~SECRET~~

UNCLASSIFIED

UNCLASSIFIED

~~SECRET~~

SECRET

UNCLASSIFIED

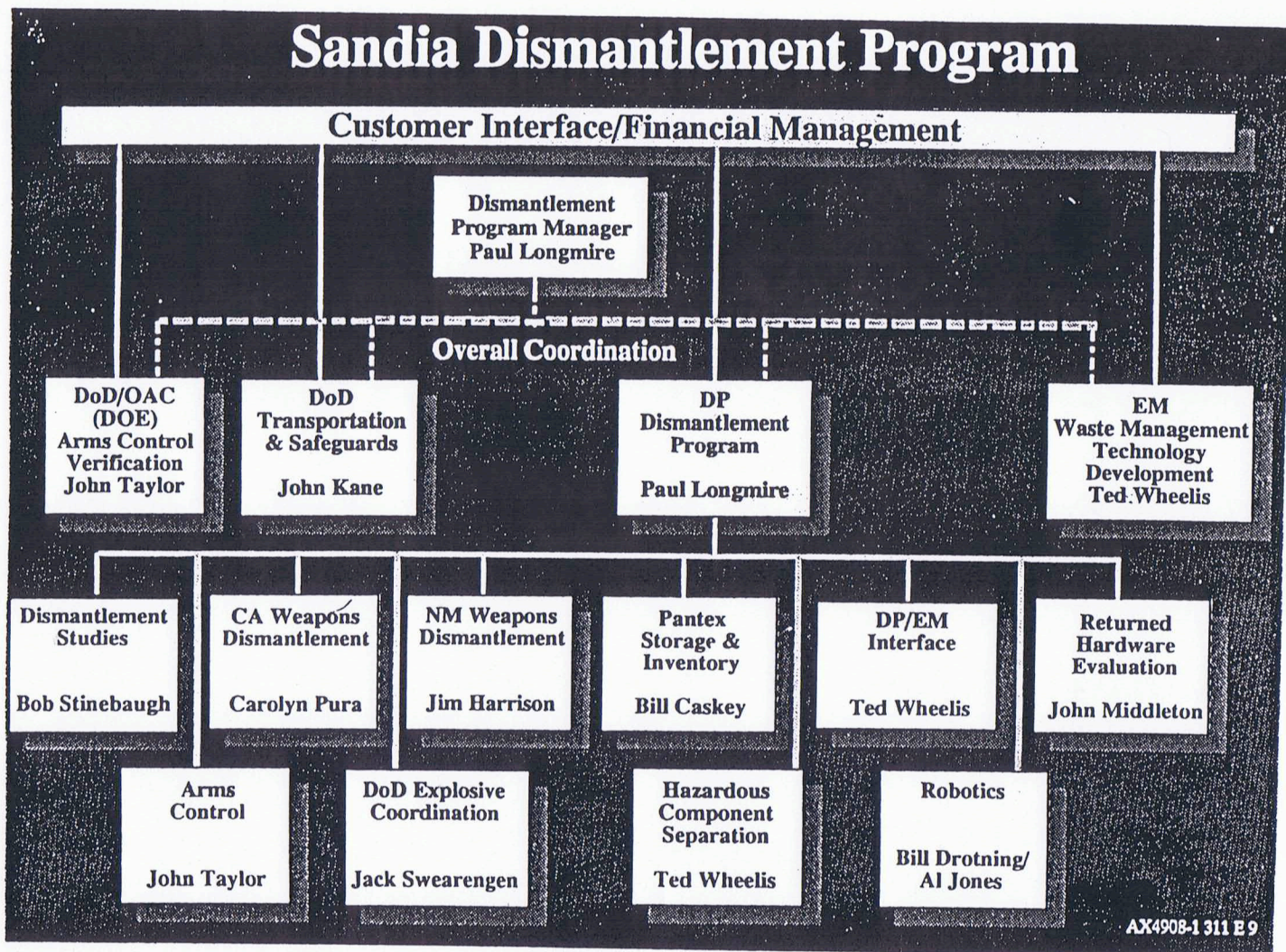

AX4908-1 311 E 9

UNCLASSIFIED

SECRET

# SURVEY OF WEAPONS DEVELOPMENT AND TECHNOLOGY

WR708

---

~~SECRET~~

UNCLASSIFIED

## SESSION XI

- DETONATORS
- FIRING SYSTEMS
- NEUTRONS INITIATION
- POWER SUPPLIES

UNCLASSIFIED

~~SECRET~~

## Topics to be discussed

---

- Review of implosion assembly (IA) operation
- Review of stockpile detonators
- Firing system components
- Operation of explosive firing sets
- Stockpile firing sets
- Nuclear safety
- Production
- Future systems

~~SECRET~~

UNCLASSIFIED

UNCLASSIFIED

~~SECRET~~

## Assumptions for briefing

---

- Students have an undergraduate background in engineering or science

~~SECRET~~

UNCLASSIFIED

UNCLASSIFIED

~~SECRET~~

# Basics of an Implosion Assembly (IA)

---

~~SECRET~~

UNCLASSIFIED

~~SECRET~~  
UNCLASSIFIED



# Typical hot wire detonator (Firing current ~ 5 amps)

---

RDX or PETN  
Density ~ 1.65 g/cc  
8300 M/sec

Lead Styphnate  
Density ~ 3.0 g/cc  
5200 M/sec

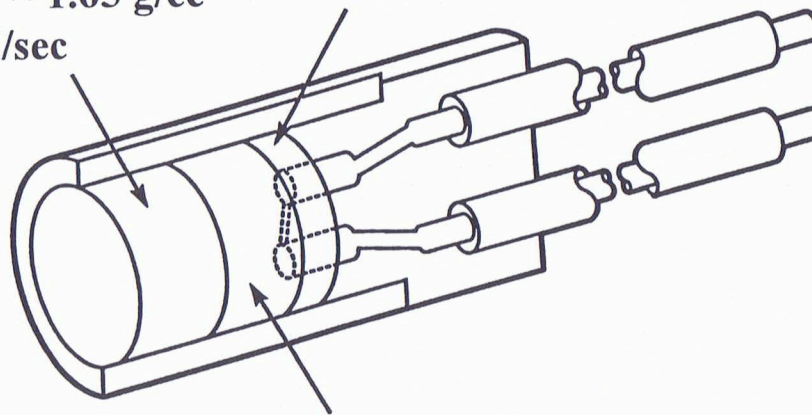

Lead Azide  
Density ~ 4.0 g/cc  
5100 M/sec

~~SECRET~~

UNCLASSIFIED

UNCLASSIFIED

~~SECRET~~

An exploding bridgewire (EBW) detonator  
(1.5 X 40 mil gold) initiation requires ~ 300  
amps

---

RDX or PETN  
Density ~ 1.65 g/cc  
8300 M/sec

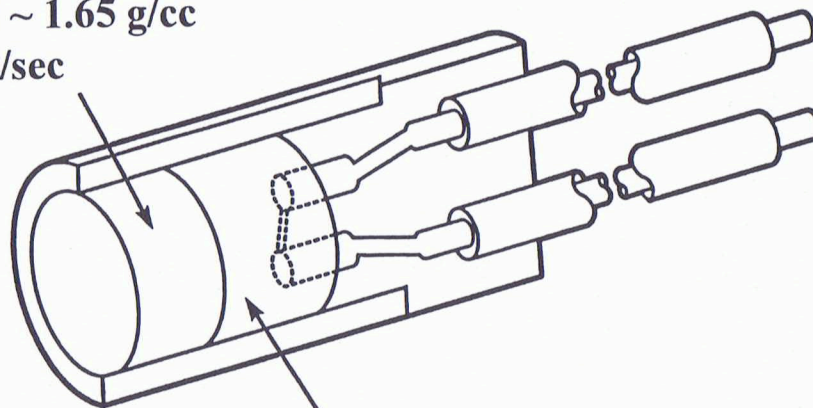

PETN  
Density ~ 0.85 g/cc  
5000 M/sec

~~SECRET~~

UNCLASSIFIED

UNCLASSIFIED

~~SECRET~~

# A basic exploding foil initiator (EFI), slapper detonator, consists of three components

---

**Secondary Explosive Pellet  
(Typically HNS IV)**

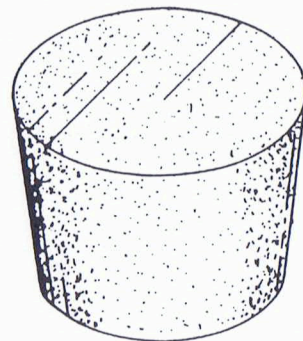

**Insulating disk with  
barrel (hole)**

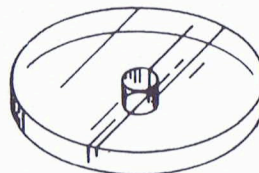

**Etched metal foil  
with insulated flyer**

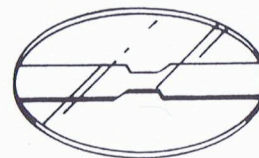

~~SECRET~~

UNCLASSIFIED

UNCLASSIFIED

~~SECRET~~

# The Mechanical Safe and Arm Device (MSAD) controls the detonator pellet in the W84 and W87

---

~~SECRET~~

UNCLASSIFIED

UNCLASSIFIED

~~SECRET~~

## EBW and EFI comparison for detonators which requires approximately the same initiation energy

---

	Exploding Bridge Wire	Exploding Foil Initiator
Energy	250 mJ	250 mJ
Current	1000 Amps	2,500 Amps
Function time	2.0 $\mu$ s	0.5 $\mu$ s
Energy coupled into explosive	~ 20 % of stored energy	~ 5 % of stored energy
Explosive	PETN (0.8 gm/cc)	HNS (1.6 gm/cc)
HE melting point	140° C (100° C degrades)	320° C (doesn't degrade)

\* EBWs need recovery; slappers don't.

\* Slappers are more environmentally rugged.

**SECRET**

UNCLASSIFIED

UNCLASSIFIED

**SECRET**

Firing set provides: 1) Low to high voltage/current conversion; 2) Fuze/Fire interface; & 3) Det/NG interface

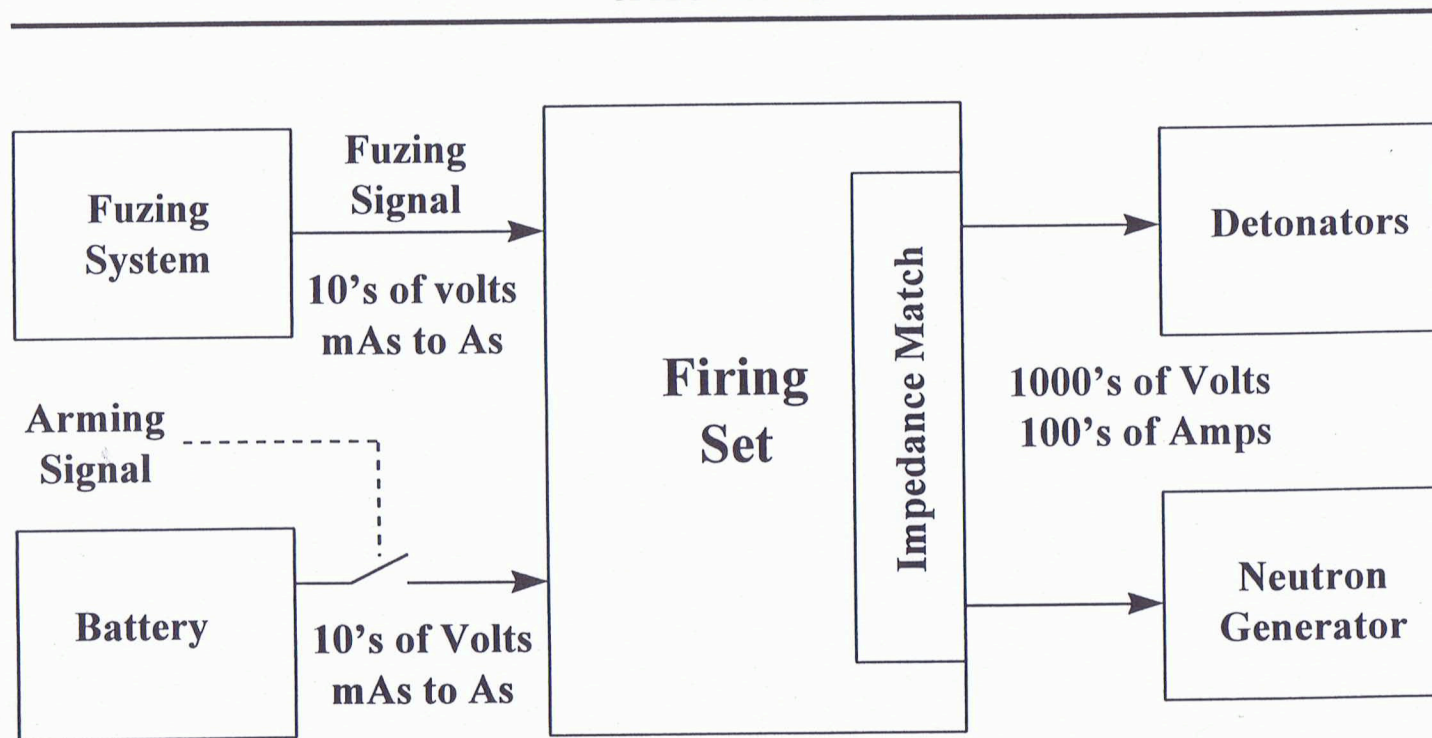

{Arming, Fuzing and Firing (AF&F)}

~~SECRET~~

UNCLASSIFIED

UNCLASSIFIED

~~SECRET~~

b(3)

## What is a capacitor? Basically two conductors seperated by a dielectric

---

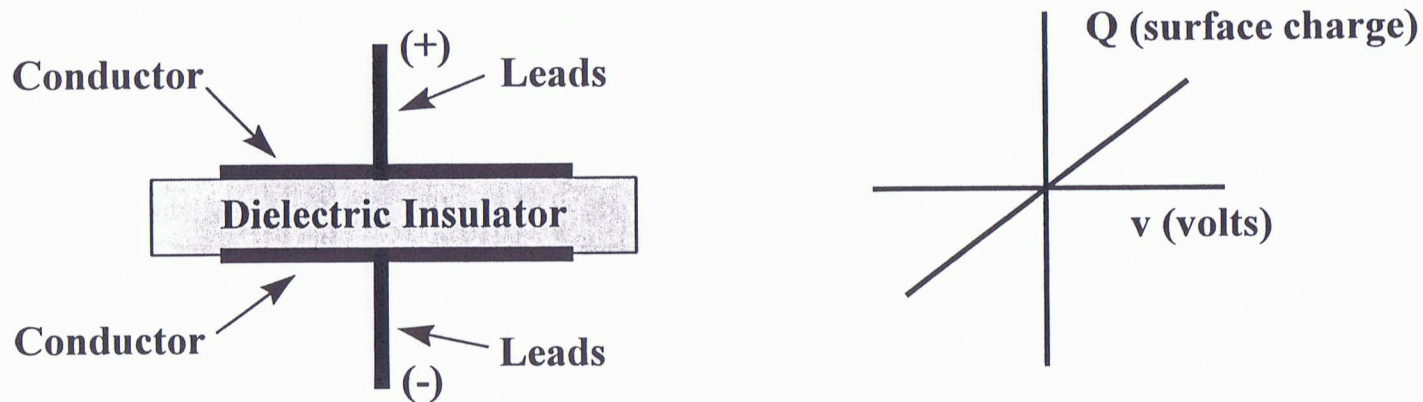

$$\text{Energy} = 1/2 CV^2 = 1/2 \frac{Q^2}{C}$$

- Q is the charge in coulombs
- C is the capacitance in farads
- V is the potential in volts

~~SECRET~~

UNCLASSIFIED

UNCLASSIFIED

~~SECRET~~



# High voltage firing set capacitor (High Energy Density (HED) capacitor )

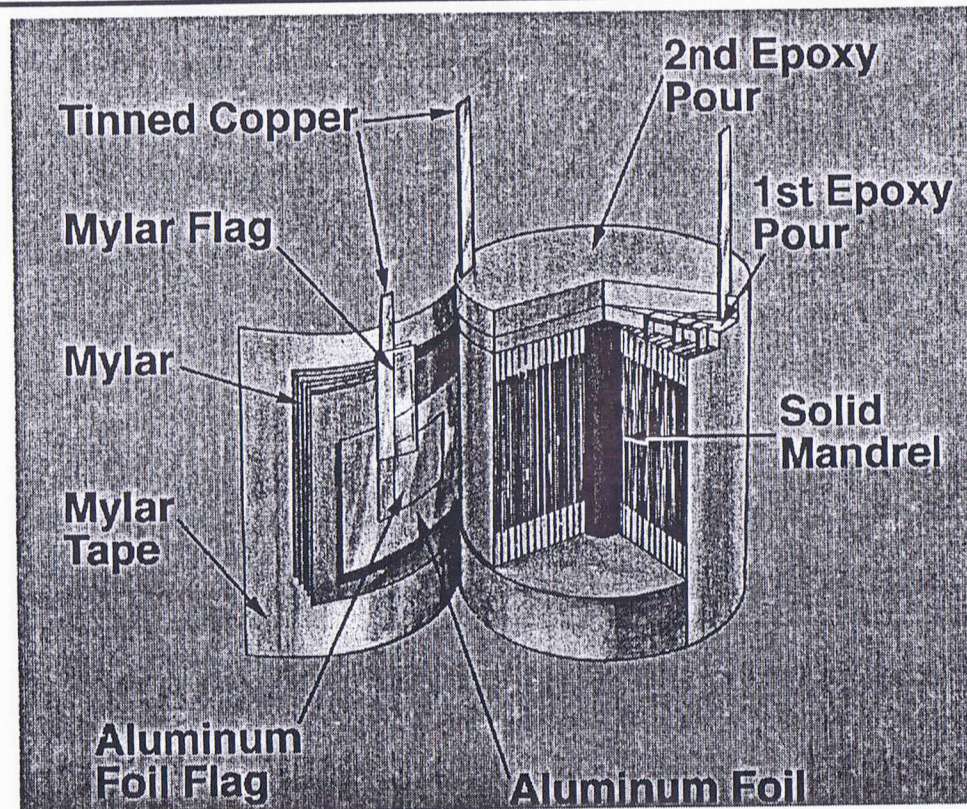

~~SECRET~~

UNCLASSIFIED

UNCLASSIFIED

~~SECRET~~

# Tradeoff of dielectric strength and dielectric constant - at field use condition

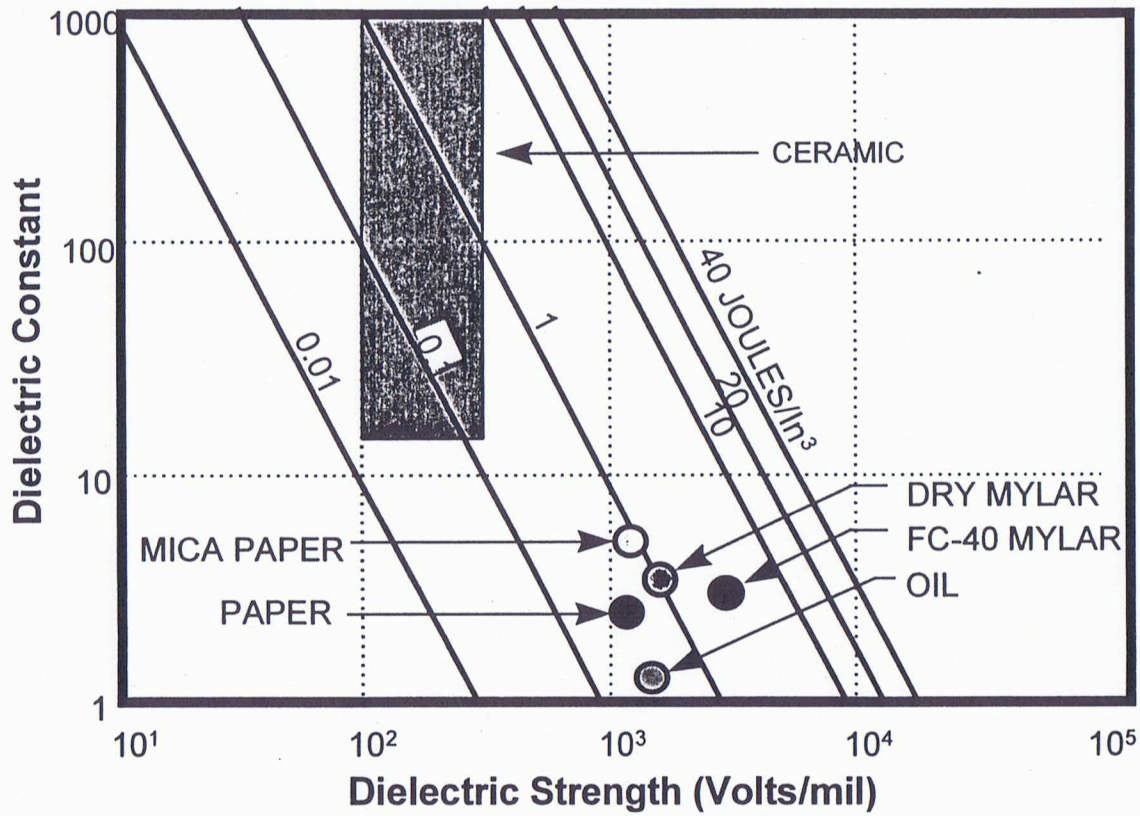

~~SECRET~~

UNCLASSIFIED

UNCLASSIFIED

~~SECRET~~

# Firing set capacitor bank for a large number of detonators

---

UNCLASSIFIED

~~SECRET~~

UNCLASSIFIED

~~SECRET~~

# Examples of high energy density capacitors

---

~~SECRET~~

UNCLASSIFIED

UNCLASSIFIED

~~SECRET~~

# Basic operation of a switch tube

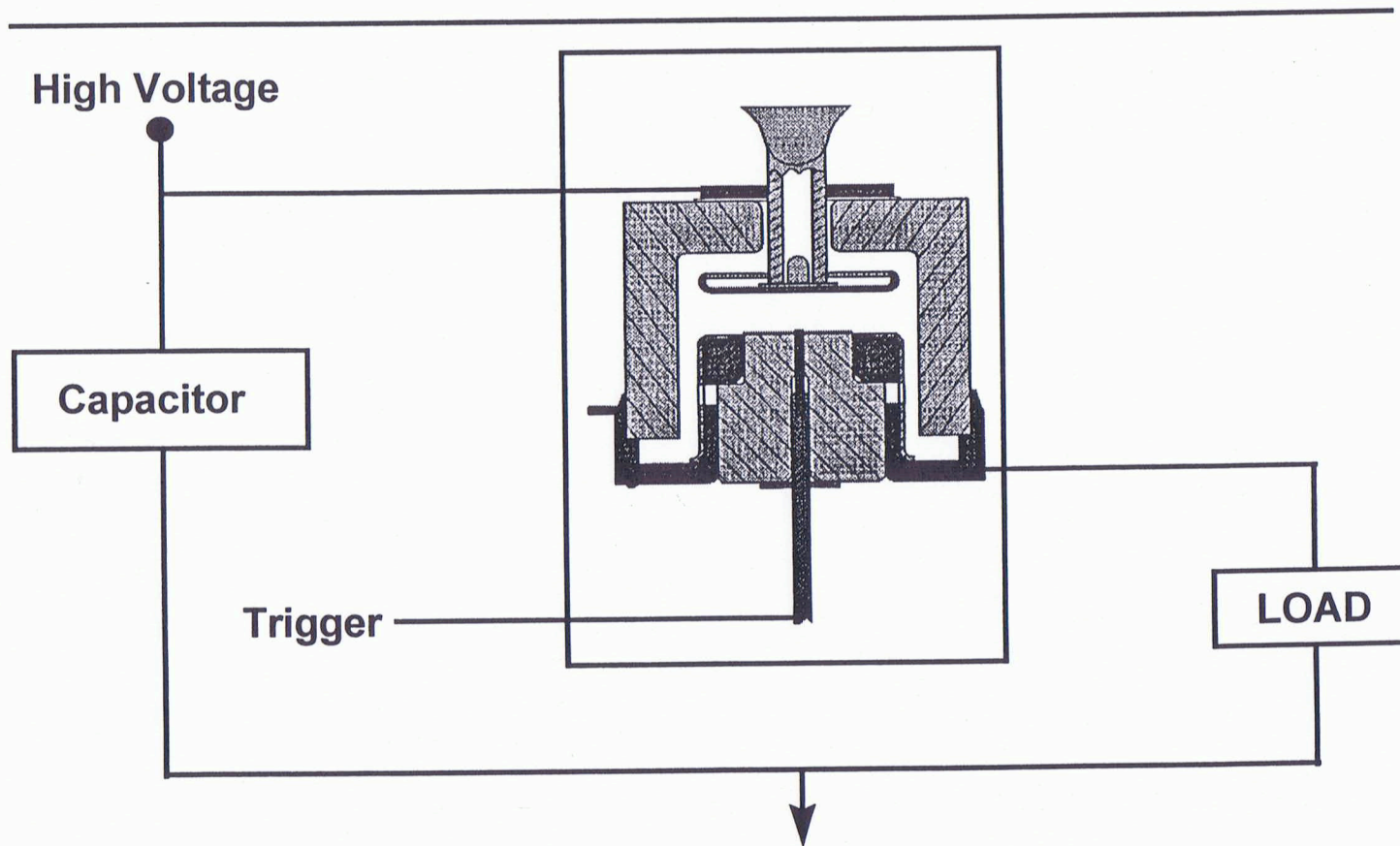

~~SECRET~~

UNCLASSIFIED

UNCLASSIFIED

~~SECRET~~

# Vacuum and gas switches

---

~~SECRET~~

UNCLASSIFIED

UNCLASSIFIED

~~SECRET~~

# Technology shift has led to reduced complexity and more repeatable processes

SECRET

UNCLASSIFIED

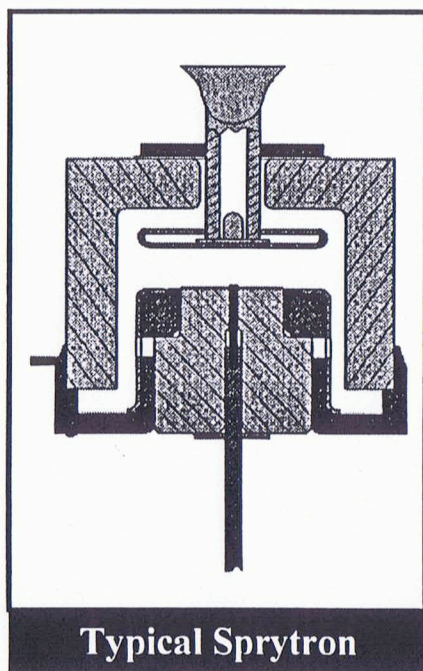

- 1 Fab/Test Cycle Time ~ 2-4 months
- 2 Unit Cost ~ \$2-3K
- 3 Facility Space ~ 65,000 sq. ft.
- 4 Facility Cost ~ \$5M
- 5 Multiple operations to closure

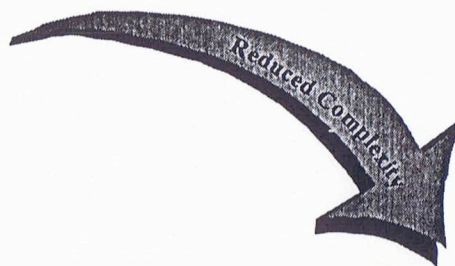

- 1 Fab/Test Cycle Time ~ 2-4 weeks
- 2 Unit Cost ~ \$200-400
- 3 Facility Space ~ 5,000 sq. ft.
- 4 Facility Cost ~ \$1M
- 5 Single Step closure

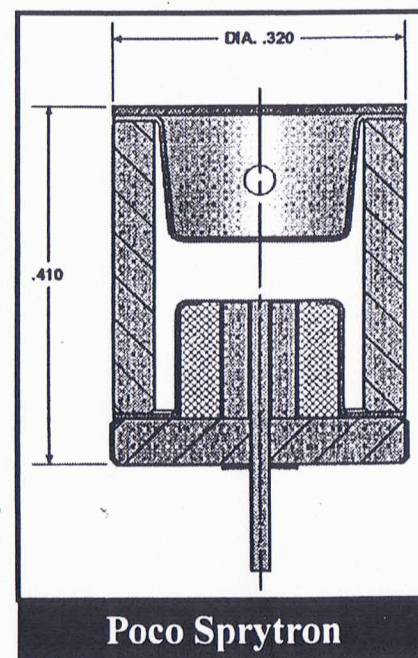

UNCLASSIFIED

SECRET

# Explosive tack switch system - (Solid dielectric switch (SDS), Explosively driven switch)

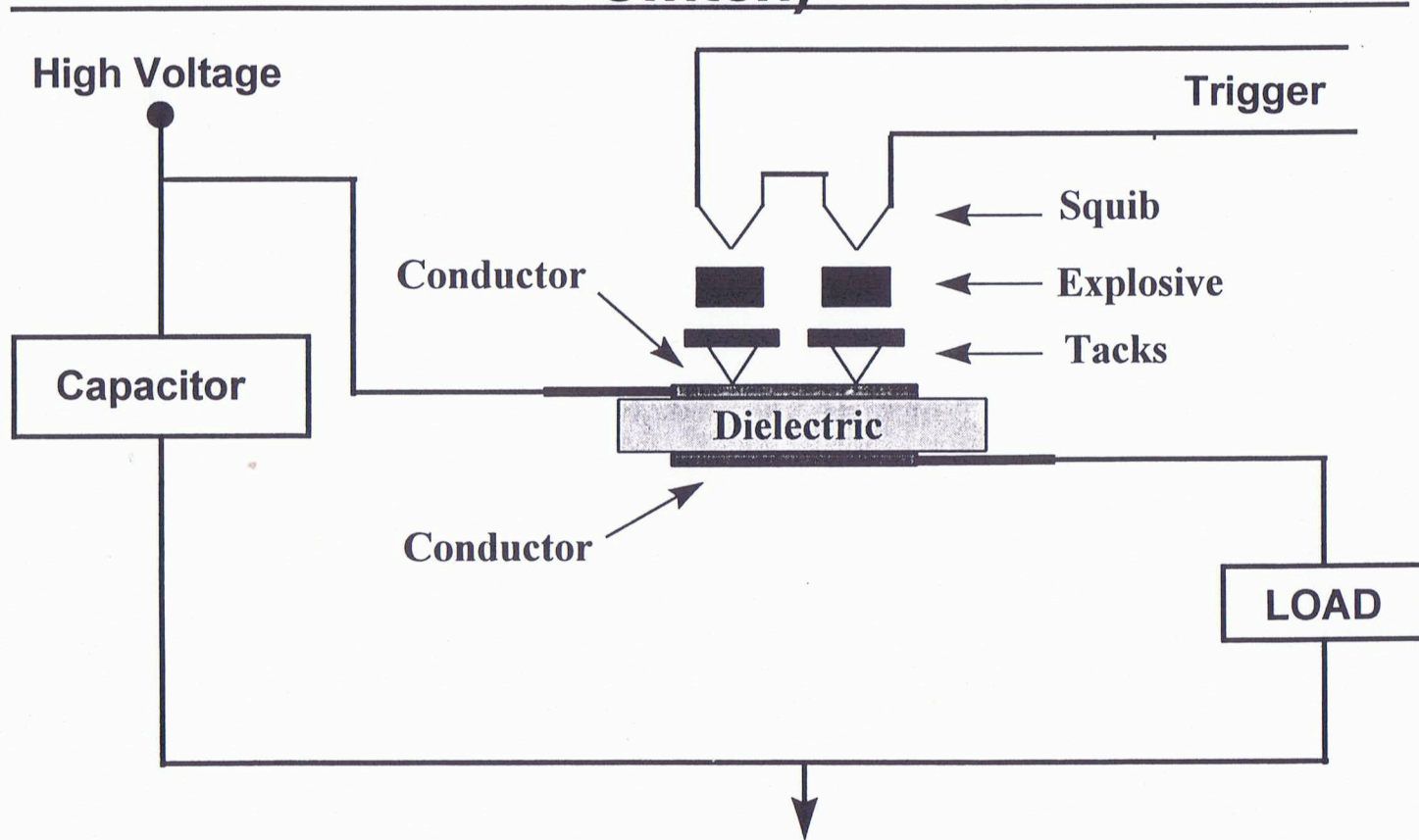

~~SECRET~~

UNCLASSIFIED

UNCLASSIFIED

~~SECRET~~



~~SECRET~~

UNCLASSIFIED

## There are two technology areas that have been employed in the stockpile

---

- **Capacitor Discharge Unit (CDU) Firing Set**
  - Typically all electric
  - Re-testable when it is all electric
- **Explosive-to-Electric Transducers (EETs)**
  - Chemical energy from explosives are used in the production of electrical energy
  - Single pulse or one shot device

UNCLASSIFIED

~~SECRET~~

**Ferroelectric (FE) material retains a bound charge like a capacitor retains a surface charge**

---

CDU

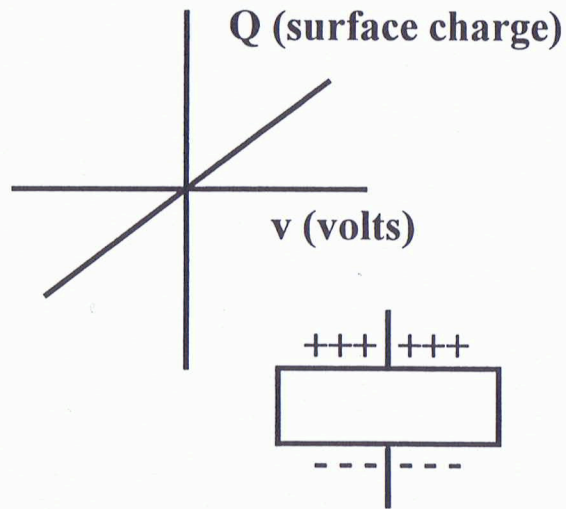

FE

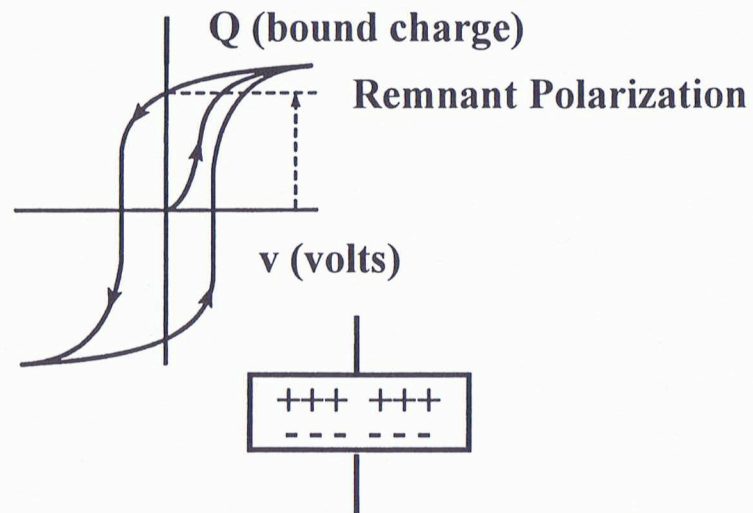

$$\text{Energy} = 1/2 CV^2 = 1/2 \frac{Q^2}{C}$$

~~SECRET~~

UNCLASSIFIED

UNCLASSIFIED

~~SECRET~~

# Bound charges are formed in a ferroelectric (FE) material during poling process

---

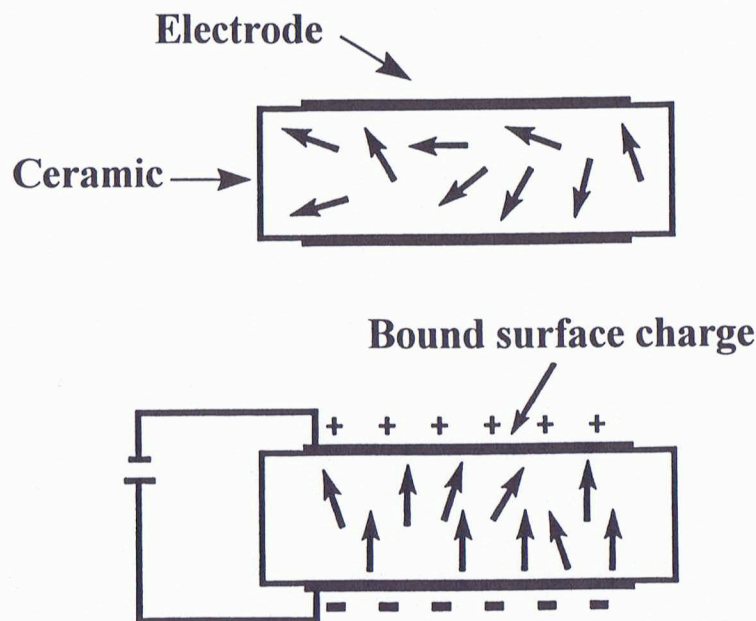

Unpoled Ceramic  
Polycrystalline multidomain  
ferroelectric ceramic

Polling Process  
Domains aligned by impressing  
external electric field

~~SECRET~~

UNCLASSIFIED

UNCLASSIFIED

~~SECRET~~

## A shock wave of the correct magnitude releases bound charges in ferroelectric (FE) material

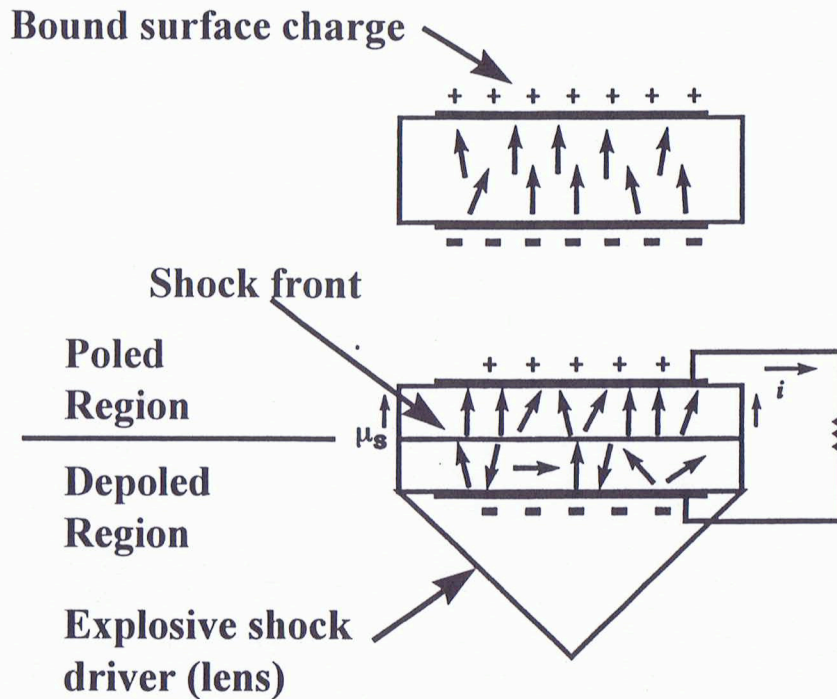

Poled Ceramic  
Bound surface charge remains due to internal electric field

Shock Depoling Process  
Shock wave randomizes dipoles eliminating internal field, thus freeing bound charge to external circuit.

~~SECRET~~

UNCLASSIFIED

UNCLASSIFIED

~~SECRET~~

# Ferroelectric firing set

---

B54 and/or Isolator

Define isolator and where it is used  
and why it is used

~~SECRET~~

UNCLASSIFIED

UNCLASSIFIED

~~SECRET~~

## Slim Loop Ferroelectric (SFE) material reduces remnant polarization to fraction of a micro coulomb

---

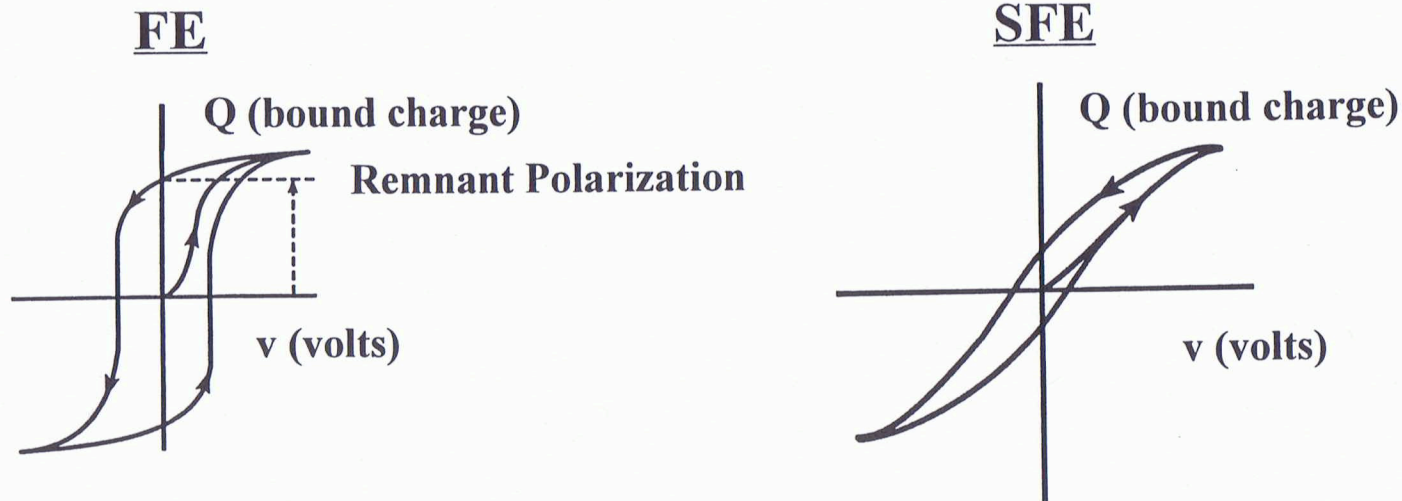

$$\text{Energy} = 1/2 CV^2 = 1/2 \frac{Q^2}{C}$$

~~SECRET~~

UNCLASSIFIED

UNCLASSIFIED

~~SECRET~~

# MC3028 Firing set

---

~~SECRET~~

UNCLASSIFIED

~~SECRET~~

## Firing set technology comparisons

<u>Firing Set Technology</u>	<u>Typical Application</u>	<u>Relative Advantages</u>	<u>Relative Disadvantages</u>
CDU	Bombs & Cruise missiles	Retestable no HE	Special effort to Harden
FE	Isolators	Power source not required, small, inherently rad hard	HE required Stored energy
SFE	Missiles (RBs, RVs)	Small, inherently rad hard	HE required Requires trigger
FM	Artillery shells (AFAPs)	Fastest arm/disarm Small, rad hard	HE required
CMF	Under ground testing (UGT)	Large output current & energy, rad hard	Long function time, HE required, requires timed trigger

~~SECRET~~

UNCLASSIFIED

UNCLASSIFIED

~~SECRET~~



## **Firing sets have many complex requirements beyond that of initiating detonators**

---

- **Firing set complexity may be driven by**
  - **Nuclear safety**
  - **Radiation**
  - **Use control**
  - **Housing/mounting for other components**
  - **Testability**
  - **Manufacturability**
  - **Cost**
- **There may not be syngerism between requirements**

~~SECRET~~

UNCLASSIFIED

UNCLASSIFIED

~~SECRET~~

## Nuclear safety requirements require the implementation of several complex features

<u>Principles</u>	<u>Implementation</u>
<b>Isolation</b>	<b>Barriers, Strong links</b>
<b>Inoperability</b>	<b>Weak links, Colocation</b>
<b>Incompatibility</b>	<b>Unique signal operated devices</b>
<b>Independence</b>	<b>Multiple independent safety subsystems</b>

~~SECRET~~

UNCLASSIFIED

UNCLASSIFIED

~~SECRET~~

# Firing system with enhanced nuclear detonation system (ENDS) features

---

~~SECRET~~

UNCLASSIFIED

~~SECRET~~

# Capacitor technology - tradeoff of thermal weak link properties and radiation properties

---

~~SECRET~~

UNCLASSIFIED

~~SECRET~~

**Packaging of the printed wiring assembly  
(PWA) in the B83 firing set before “sylgard  
184 GMB”**

---

~~SECRET~~

UNCLASSIFIED

UNCLASSIFIED

~~SECRET~~

**Packaging of the printed wiring assembly  
(PWA) in the B83 firing set after “sylvard 184  
GMB”**

---

~~SECRET~~

UNCLASSIFIED

UNCLASSIFIED

~~SECRET~~

# Simple nuclear weapon firing set

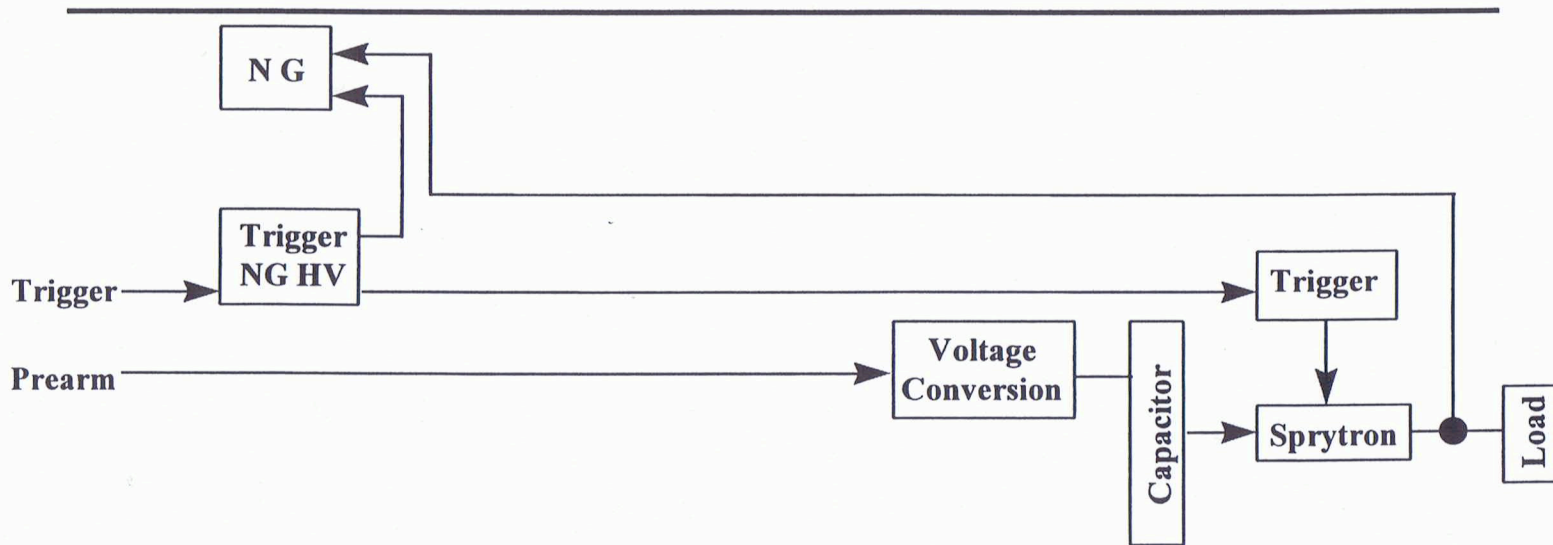

UNCLASSIFIED

~~SECRET~~

~~SECRET~~

UNCLASSIFIED

UNCLASSIFIED

~~SECRET~~

b (3)

~~SECRET~~

UNCLASSIFIED



# Firing systems in the active stockpile

---

~~SECRET~~

UNCLASSIFIED

UNCLASSIFIED

~~SECRET~~

# Firing sets and detonators in the active stockpile

---

~~SECRET~~

UNCLASSIFIED

UNCLASSIFIED

~~SECRET~~

**Firing set production is ongoing at a low level**

---

<u>Weapon</u>	<u>MC Number</u>	<u>Technology</u>	<u>Quantity</u>
<b>B83</b>	<b>MC3971A</b>	<b>CDU</b>	<b>~ 10/month ongoing</b>
<b>W87</b>	<b>MC3719</b>	<b>CDU</b>	<b>~ 3-4/month starting 1998</b>

UNCLASSIFIED

~~SECRET~~

UNCLASSIFIED

~~SECRET~~

# Roadmap for Advanced Firing/Detonation Systems (AF/DS) supports future stockpile needs

~~SECRET~~

UNCLASSIFIED

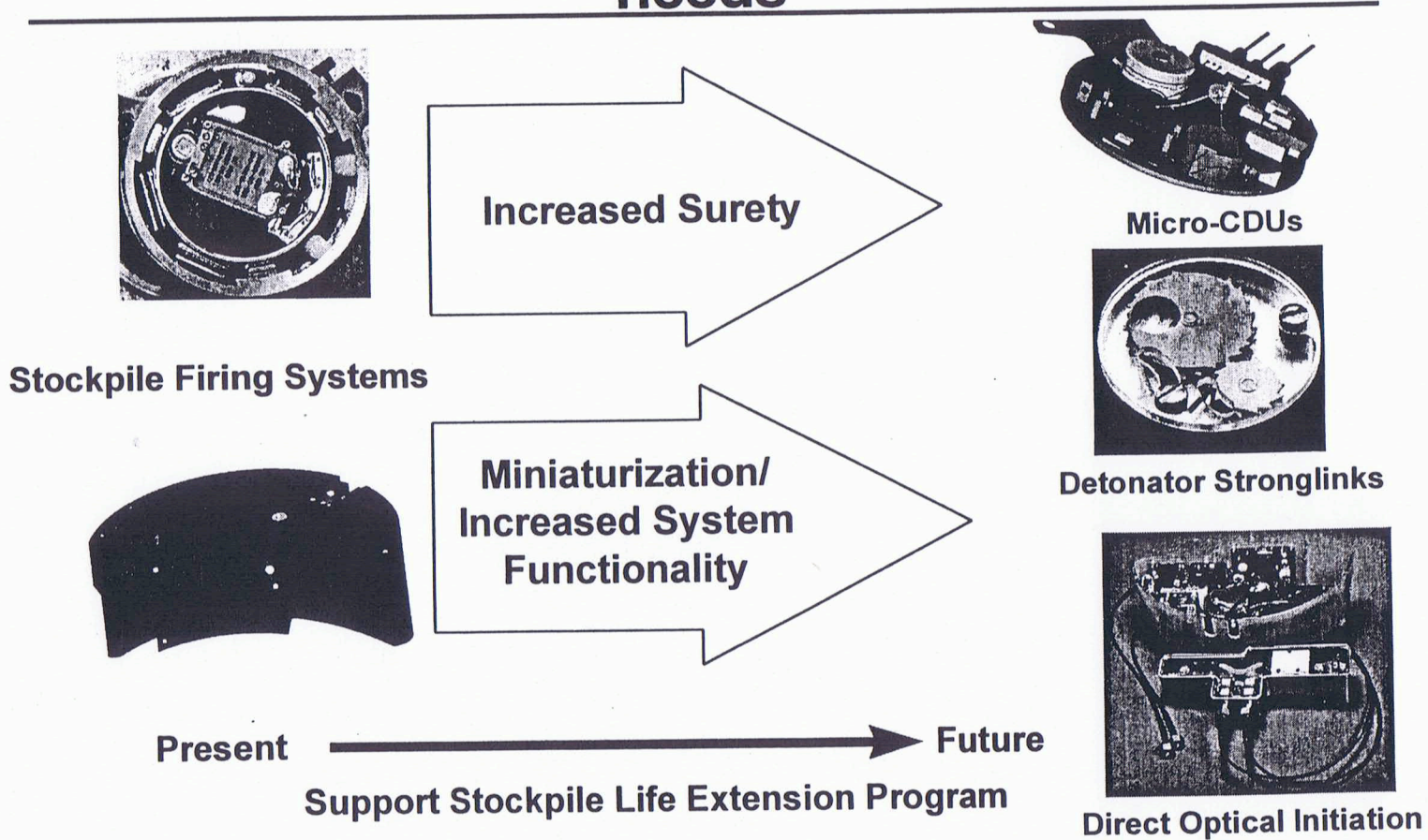

UNCLASSIFIED

~~SECRET~~

# Micro firing set

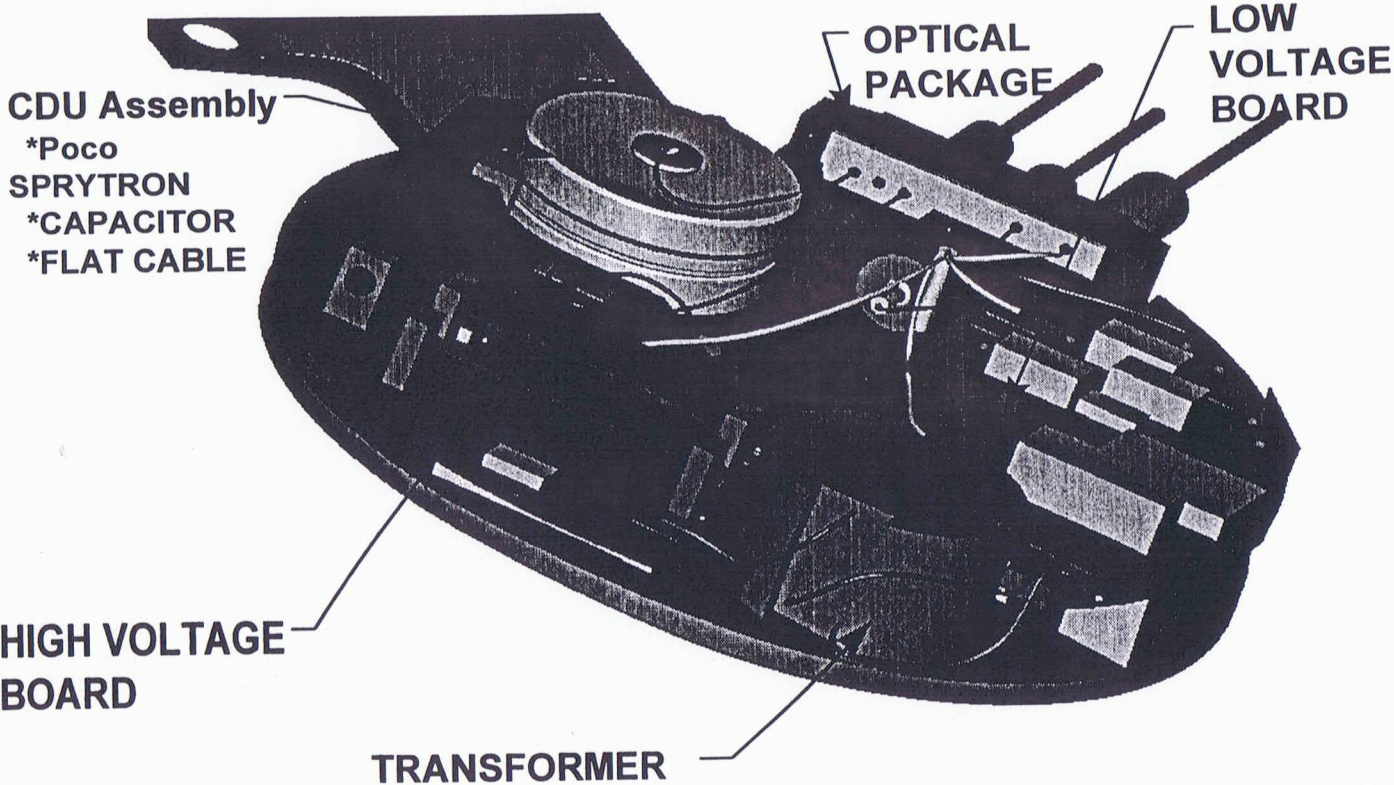

~~SECRET~~

UNCLASSIFIED

UNCLASSIFIED

~~SECRET~~

# Micro CDU firing set working prototype

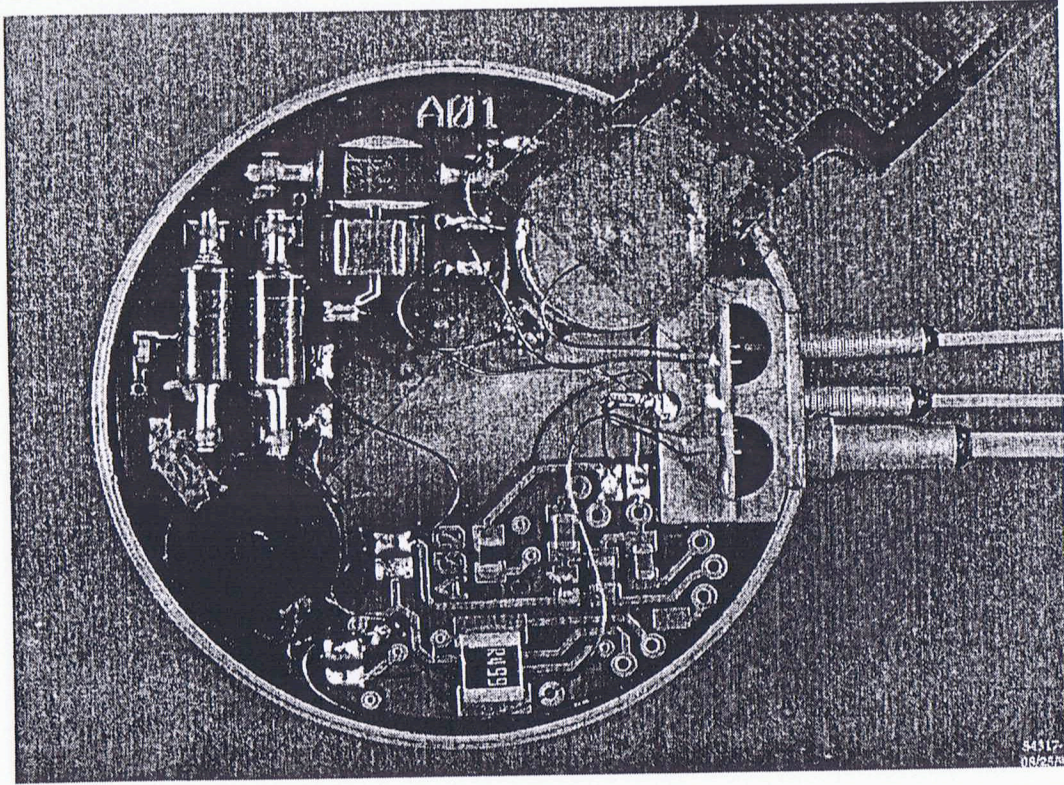

~~SECRET~~

UNCLASSIFIED

UNCLASSIFIED

~~SECRET~~

# Micro CDU - 0.23 in<sup>3</sup> - Working prototype

---

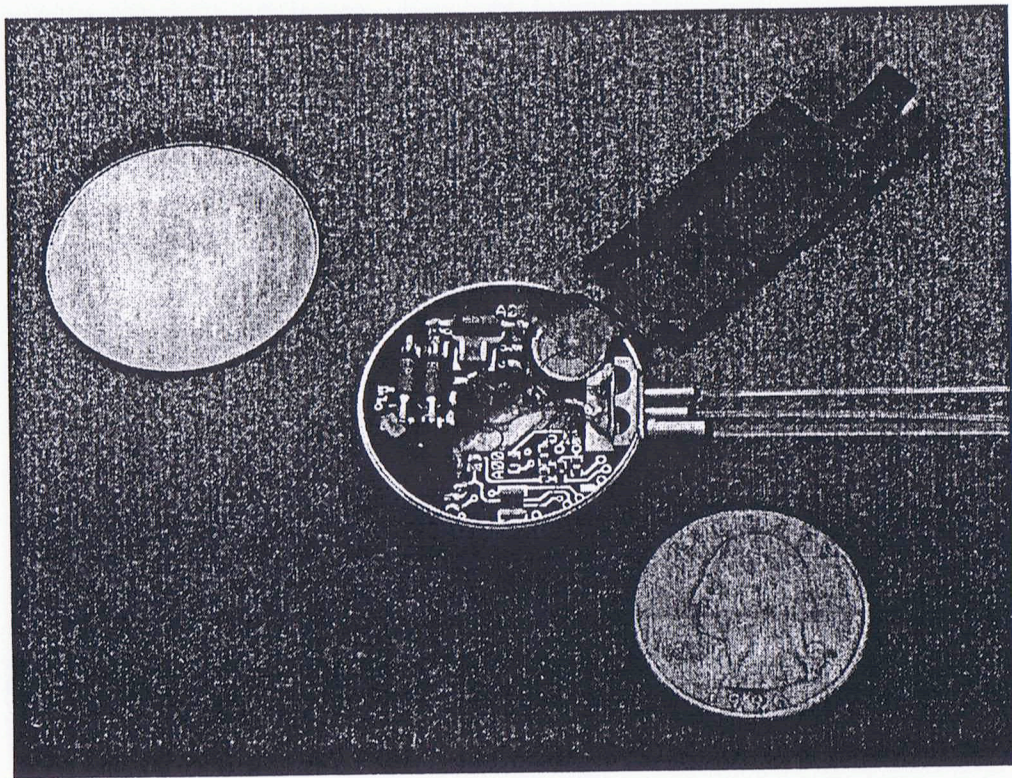

**SECRET**

UNCLASSIFIED

UNCLASSIFIED

**SECRET**

# Neutron Initiators

## Topics to be discussed

---

- Internal initiators
- External initiators
- Movie - An overview of neutron source technology
- Technology involved
- Evolution of neutron generator development
- Production
- Future systems

~~SECRET~~

UNCLASSIFIED

UNCLASSIFIED

~~SECRET~~



# Basics of an Implosion Assembly (IA)

---

~~SECRET~~

UNCLASSIFIED

UNCLASSIFIED

~~SECRET~~

# Neutron yield is dependent on ion source material and ion energy

---

~~SECRET~~

UNCLASSIFIED

UNCLASSIFIED

~~SECRET~~

# Neutron multiplication rate

---

~~SECRET~~

UNCLASSIFIED

UNCLASSIFIED

~~SECRET~~

## There are two fundamental reasons neutron sources are used in weapons

---

- Jump start the weapon
- Stabilizes the output

~~SECRET~~

UNCLASSIFIED

UNCLASSIFIED

~~SECRET~~

# Alpha curve

---

~~SECRET~~

UNCLASSIFIED

UNCLASSIFIED

~~SECRET~~

# Show Movie

---

~~SECRET~~

UNCLASSIFIED

UNCLASSIFIED

~~SECRET~~

# Basics of how a neutron tube work

---

Picture of a neutron tube

~~SECRET~~

UNCLASSIFIED

UNCLASSIFIED

~~SECRET~~

# Neutron generator using an explosive to electric (EET) power supply

---

~~SECRET~~

UNCLASSIFIED

~~SECRET~~

UNCLASSIFIED



# Neutron generator using an electronic power supply

---

~~SECRET~~

UNCLASSIFIED

UNCLASSIFIED

~~SECRET~~

# Implosion Assembly (IA) timing requirements

---

~~SECRET~~

UNCLASSIFIED

UNCLASSIFIED

~~SECRET~~

# Neutron generations requirements over time

---

~~SECRET~~

UNCLASSIFIED

UNCLASSIFIED

~~SECRET~~

## Neutron generator timing is affected by several factors

---

- System center time shift with temperature
- Neutron generator center time shift with temperature
- Neutron generator jitter
- Firing set jitter
- Weapon detonator jitter
- Neutron generator detonator jitter (explosive NG)
- Shift in electronic components (electronic NG)

~~SECRET~~

UNCLASSIFIED

UNCLASSIFIED

~~SECRET~~

# Neutron generator "family" picture

---

~~SECRET~~

UNCLASSIFIED

UNCLASSIFIED

~~SECRET~~

## SNL is now the production agency for neutron generators

---

- The targets will be loaded at LANL
- The first production requirement is for the W76 (2000)
  - MC4277 Neutron Tube
  - MC4380 Neutron Generator
- Future need for a small tube/generator for W80
  - FY2008? (P&PD 96-0)
  - Requires the small neutron tube, MC4300
  - MC4600 neutron generator

~~SECRET~~

UNCLASSIFIED

UNCLASSIFIED

~~SECRET~~

# MC4380 Neutron generator

---

~~SECRET~~

UNCLASSIFIED

UNCLASSIFIED

~~SECRET~~

# MC4300 Neutron Tube

---

~~SECRET~~

UNCLASSIFIED

~~SECRET~~

UNCLASSIFIED



**Design evolution from the MC4300 neutron tube (W76) to the MC4600 neutron tube (future applications)**

---

~~SECRET~~

UNCLASSIFIED

UNCLASSIFIED

~~SECRET~~

## Power Systems

---

- Basic battery types
- Examples of non thermal batteries
- Thermal battery applications
- Thermal battery operation
- Examples of thermal batteries
- Power supply design influences
- Battery performance
- Evolution of Battery Development
- Production
- Future Technology

~~SECRET~~

UNCLASSIFIED

UNCLASSIFIED

~~SECRET~~

## Basic battery types

---

- **Primary: not rechargeable**
  - **Active: power immediately available**
  - **Reserve: must be activated**
- **Secondary: rechargeable**
- **Nearly all nuclear weapon batteries are primary batteries**
- **Most weapon batteries are reserve batteries**

~~SECRET~~

UNCLASSIFIED

~~SECRET~~

UNCLASSIFIED

## Types of power sources in nuclear weapons

---

- Thermally activated
- Rechargeable - Ni/Cd
- Reserve - Zn/AgO
- Active - Li/SO<sub>2</sub>
- Active and reserve - Li/SOCL<sub>2</sub>
- RTG (fissionable heat source)
  - Radio isotropic Thermal electric Generator (RTG)
- Double-layer capacitor

~~SECRET~~

UNCLASSIFIED

UNCLASSIFIED

~~SECRET~~

# Non thermal battery applications

---

- SA2039

~~SECRET~~

UNCLASSIFIED

UNCLASSIFIED

~~SECRET~~

# Picture of a generic thermal battery

---

~~SECRET~~

UNCLASSIFIED

UNCLASSIFIED

~~SECRET~~

## Picture of thermal battery cell

---

- Current
- Voltage
- Anode, cathode, electrolyte
- Thermal vs current handling requirements

~~SECRET~~

UNCLASSIFIED

UNCLASSIFIED

~~SECRET~~

## Thermal batteries are used in many nuclear weapon applications

---

- RADARs
- Programmers
- Timer
- Firing sets
- Spin rocked motors
- Parachute deployment
- Telemetry
- Command disable
- Command enable
- Fin activation

~~SECRET~~

UNCLASSIFIED

UNCLASSIFIED

~~SECRET~~



## What is a thermal battery?

---

- Thermal batteries are primary reserve batteries that employ inorganic salt electrolytes, which are nonconductive solids at ambient temperatures, and integral pyrotechnic materials scaled to supply sufficient thermal energy to melt the electrolyte.

~~SECRET~~

UNCLASSIFIED

~~SECRET~~

UNCLASSIFIED

# Movie

---

- Thermal Battery Ignition

~~SECRET~~

UNCLASSIFIED

UNCLASSIFIED

~~SECRET~~

**Thermal battery performance- voltage -  
with constant load**

---

~~SECRET~~

UNCLASSIFIED

UNCLASSIFIED

~~SECRET~~

# Thermal battery performance- current - with constant load

---

~~SECRET~~

UNCLASSIFIED

UNCLASSIFIED

~~SECRET~~

# Calcium chromate performance

---

~~SECRET~~

UNCLASSIFIED

UNCLASSIFIED

~~SECRET~~

# Lithium battery performance

---

~~SECRET~~

UNCLASSIFIED

UNCLASSIFIED

~~SECRET~~

~~SECRET~~

UNCLASSIFIED

b(3)

~~SECRET~~  
UNCLASSIFIED

## Power supply design influences

---

- Reliability (0.995 - 0.997)
- Shelf life - Thermal battery > 25 years
- Ruggedness - W82 AFAP application
- Operating temperature
- Current density
- Pulse capability
- Voltage - determined by cell chemistry

~~SECRET~~

UNCLASSIFIED

~~SECRET~~  
UNCLASSIFIED



## **Thermal batteries are mechanically and environmentally robust**

---

- **Example of the W82 AFAP MC3714 environmental requirements**
  - **Spin: 18,000 rpm**
  - **Setback acceleration : 17,000 g's, 10 ms**
  - **Angular acceleration: 40,000 rad/sec<sup>2</sup>**
  - **Ramming shock: 440 g, 1.83 ms, haversine**
  - **Rebound acceleration: 4000 g's 0.3 ms**

~~SECRET~~

UNCLASSIFIED

UNCLASSIFIED

~~SECRET~~

The three dimensional design space for batteries is volume, performance, and life

---

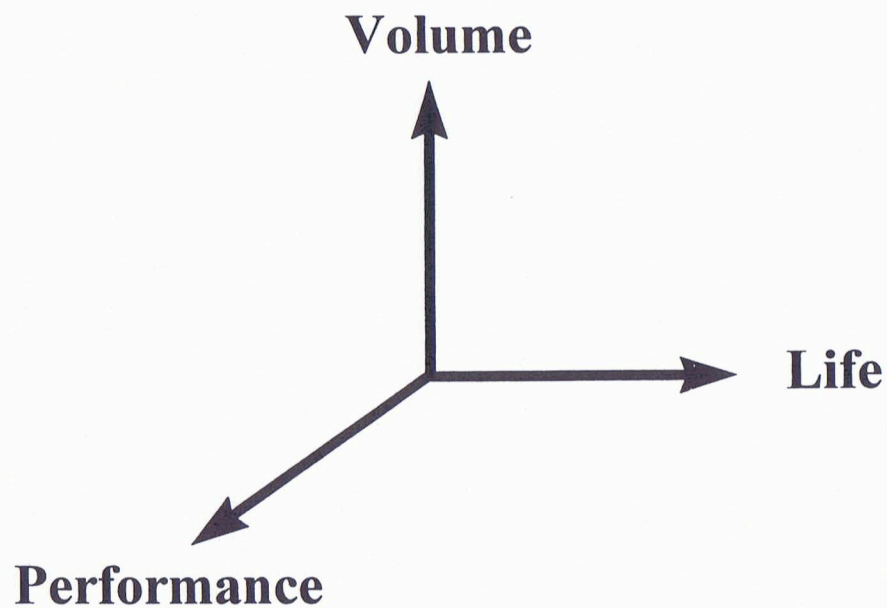

~~SECRET~~

UNCLASSIFIED

UNCLASSIFIED

~~SECRET~~

# Picture showing thermal battery performance versus size

---

~~SECRET~~

UNCLASSIFIED

UNCLASSIFIED

~~SECRET~~

## Typical thermal battery performance Values based on Li(Si)/FeS<sub>2</sub> system

<u>Battery Type</u>	<u>Active Life</u> (sec)	<u>Min Volts</u> (v)	<u>Current Density</u> (mA/cm <sup>2</sup> )	<u>Specific Power</u> (W/Kg)	<u>Volume</u> (cc)
Pulse	0.050	17.5	7500	8000	10
Pulse	5	26	1000	1700	10
Power	200	12	1800	740	1640
Power	60	25	300	260	137
Power	120	26	120	80	360
Power	1200	26	100	80	320
Long Life	4500	13	55	18	320

~~SECRET~~

UNCLASSIFIED

~~SECRET~~

UNCLASSIFIED

## Examples of batteries used in the US nuclear weapons program

<u>Weapon</u>	<u>Technology</u>	<u>Cell Voltage</u>	<u>Approx. Date</u>
Little Boy	Lead Acid	2.0 volts	1945
Fat Man	Lead Acid	2.0 volts	1945
MK4,5,6,7	Nickel-Cadium	1.2 volts	1953
MK15	Thermal CA-CaCrO <sub>4</sub>	2.5 volts	1955
W62	Silver-Zinc	1.8 volts	1970
W70	Thermal Li/FeS <sub>2</sub>	1.9 volts	1973
B83	Thermal Li/CoS <sub>2</sub>	1.8 volts	1980's

~~SECRET~~

UNCLASSIFIED

UNCLASSIFIED

~~SECRET~~

# W76 thermal battery

---

~~SECRET~~

UNCLASSIFIED

UNCLASSIFIED

~~SECRET~~

# MC2936 thermal battery

---

~~SECRET~~

UNCLASSIFIED

UNCLASSIFIED

~~SECRET~~

## **Battery production is currently taking place at three production agencies (PAs)**

---

- **Eagle Pitcher**
  - The primary PA which resulted from the nonnuclear reconfiguration study
- **SNL**
  - The backup site for production which resulted from the nonnuclear reconfiguration study
- **Enser Corporation - Private Corporation**
  - Recently formed out of Martin Marietta Specialty Components, Inc. (GEND, Pinellas Plant)

~~SECRET~~

UNCLASSIFIED

UNCLASSIFIED

~~SECRET~~



## Battery production is at a low level

<u>Company</u>	<u>Nomenclature</u>	<u>Type</u>	<u>Application</u>	<u>Quantity</u>
Eagle Pitcher	SA3562	Zn/AgO	JTA	~ 2 Dozen
	MC3471A	Thermal	B61	300-400
	MC2736A	Thermal	JTA	~ 2 Dozen
Enser	MC3323A	Thermal	W80 JTA	~ 2 Dozen
SNL	MC4152	Thermal	B61 Common JTA	~ 2 Dozen

~~SECRET~~

UNCLASSIFIED

~~SECRET~~

UNCLASSIFIED

## Aerogel and a heater may increase battery output without increasing volume

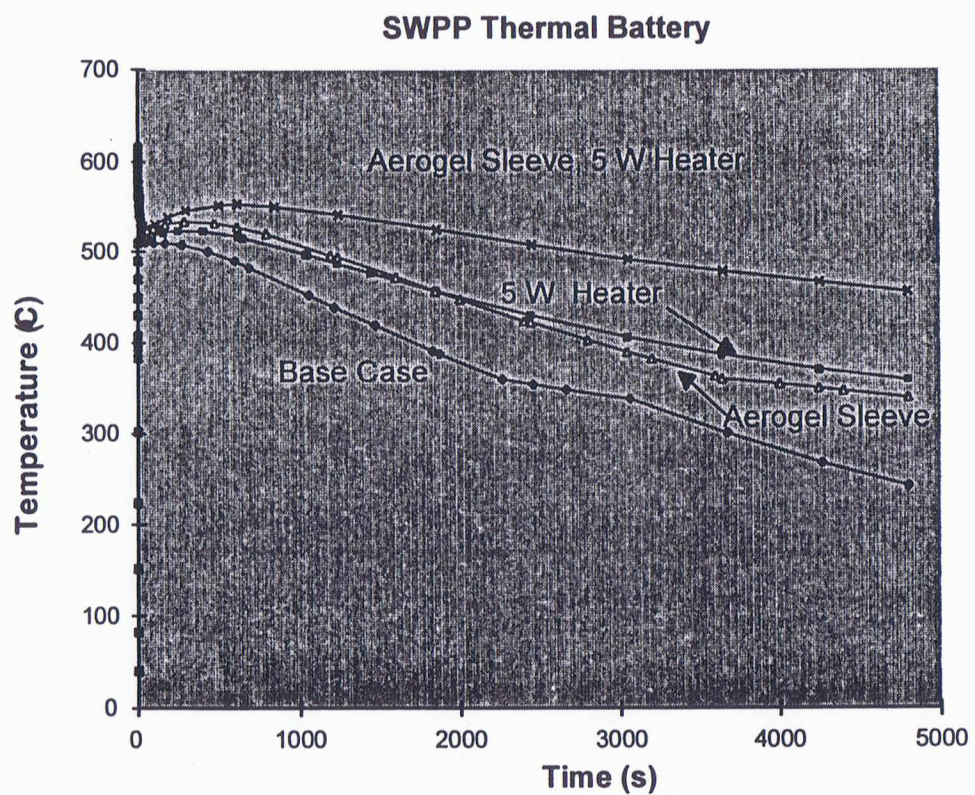

~~SECRET~~

UNCLASSIFIED

UNCLASSIFIED

~~SECRET~~

# SURVEY OF WEAPONS DEVELOPMENT AND TECHNOLOGY

WR708

SESSION XII

•NUCLEAR TESTING

*SECRET*  
UNCLASSIFIED

UNCLASSIFIED

**PHYSICS PACKAGE DEVELOPMENT TOOLS**

- **THEORY**
- **NON-NUCLEAR TESTING**
- **NUCLEAR TESTING**

~~SECRET~~

UNCLASSIFIED

~~SECRET~~

UNCLASSIFIED

## NON-NUCLEAR IMPLOSION DIAGNOSTICS

- PHERMEX (RADIOGRAPHY)
- PIN DOME
- HIGH SPEED PHOTOGRAPHY

~~SECRET~~  
UNCLASSIFIED

~~SECRET~~  
UNCLASSIFIED

**NUCLEAR TESTING**

- WEAPON DEVELOPMENT
- EFFECTS
- VULNERABILITY AND HARDENING
- STOCKPILE RELIABILITY
- PEACEFUL NUCLEAR EXPLOSIVES

~~SECRET~~

UNCLASSIFIED

~~SECRET~~

UNCLASSIFIED

~~SECRET~~

UNCLASSIFIED

(3)

~~SECRET~~

UNCLASSIFIED

DIAGNOSTICS

- YIELD
- “ALPHA”
- CHANNEL TEMPERATURES
- INTERSTAGE TIME
- OTHER

~~SECRET~~  
UNCLASSIFIED

~~SECRET~~  
UNCLASSIFIED



REFERENCES

•LA2000 1947 SRD  
•WT900 DEC 1953 SRD

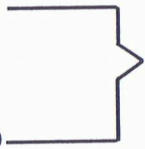

FIREBALL YIELD

•SAND 77-0402 - "SHOCK PROPAGATION..." SLIPHER

•DNA-119M REPORT

•DASA 1211 - 1220 REPORTS

•LLNL RESEARCH MONTHLY 3141-83-1033 (DIAGNOSTICS)

•DNA 170M REPORTS

•LASL-LLL SPECIFIC TEST REPORTS

~~SECRET~~  
UNCLASSIFIED

~~SECRET~~  
UNCLASSIFIED

THIS PAGE LEFT BLANK INTENTIONALLY

~~SECRET~~  
UNCLASSIFIED

~~SECRET~~  
UNCLASSIFIED

# SURVEY OF WEAPONS DEVELOPMENT AND TECHNOLOGY WR708

## SESSION XIII

### •TRANSFER SYSTEMS

~~SECRET~~

UNCLASSIFIED

~~SECRET~~  
UNCLASSIFIED

# GAS TRANSFER SYSTEM TECHNOLOGY

STEVEN ROBINSON, 8412

COMPONENT DEVELOPMENT DEPARTMENT

~~SECRET~~  
UNCLASSIFIED

~~SECRET~~  
UNCLASSIFIED

# SANDIA GAS TRANSFER SYSTEMS

- Classification
- Introduction
- Examples
  - Systems
  - Reservoirs
  - Valves
- Concerns

~~SECRET~~

UNCLASSIFIED

~~SECRET~~

UNCLASSIFIED

(3)

~~SECRET~~  
UNCLASSIFIED

UNCLASSIFIED

~~SECRET~~

~~SECRET~~ UNCLASSIFIED

b (3)

UNCLASSIFIED

~~SECRET~~

## BOOSTING

DEUTERIUM AND TRITIUM ARE USED TO MAKE PLUTONIUM BURN MORE EFFICIENTLY (I.E., TO "BOOST" THE FISSION YIELD).

HIGH EXPLOSIVE



"SLOW" FISSION BURN



IGNITION OF D/T



FLOOD OF HIGH ENERGY NEUTRONS



"FAST," EFFICIENT FISSION BURN

~~SECRET~~

UNCLASSIFIED

~~SECRET~~  
UNCLASSIFIED



# Tritium

---

~~SECRET~~  
UNCLASSIFIED

~~SECRET~~  
UNCLASSIFIED

b (3)

b (3)

~~SECRET~~

UNCLASSIFIED

~~SECRET~~

UNCLASSIFIED

~~SECRET~~ UNCLASSIFIED

b (3)

UNCLASSIFIED

~~SECRET~~

WEAPON BOOSTING REQUIRES THE  
ABILITY TO STORE MIXTURES OF  
HYDROGEN ISOTOPES AND TO DELIVER  
THE APPROPRIATE MIXTURE ON DEMAND

THIS REQUIRES

- Containment reservoirs
- Flow Systems
- Explosive Valves

~~SECRET~~

UNCLASSIFIED

~~SECRET~~

UNCLASSIFIED

~~SECRET~~

(3)

UNCLASSIFIED

UNCLASSIFIED

~~SECRET~~

(3)

~~SECRET~~

UNCLASSIFIED

UNCLASSIFIED

~~SECRET~~

(3)

~~SECRET~~  
UNCLASSIFIED

UNCLASSIFIED

~~SECRET~~

b(3)

~~SECRET~~

UNCLASSIFIED

~~SECRET~~  
UNCLASSIFIED



b(3)

DOE

~~SECRET~~

UNCLASSIFIED

~~SECRET~~  
UNCLASSIFIED

---

## CHALLENGES WITH GAS TRANSFER SYSTEMS

---

- Long Term Degradation
- Constancy of Delivery
- Complex Plumbing
- Minimization of Weight and Volume
- Cost

~~SECRET~~  
UNCLASSIFIED

~~SECRET~~  
UNCLASSIFIED

~~SECRET~~  
UNCLASSIFIED

b (3)

UNCLASSIFIED

~~SECRET~~

~~SECRET~~

UNCLASSIFIED

b (3)

~~SECRET~~  
UNCLASSIFIED

STOCKPILE LIFE, YEARS

~~SECRET~~ UNCLASSIFIED

(3)

UNCLASSIFIED

~~SECRET~~

b(3)

~~SECRET~~

UNCLASSIFIED

~~SECRET~~

UNCLASSIFIED

~~SECRET~~

UNCLASSIFIED

b(3)

UNCLASSIFIED

~~SECRET~~

b (3)



**ATDRIUM**

UNCLASSIFIED

~~SECRET~~  
UNCLASSIFIED



**SECRET**

UNCLASSIFIED

b (3)

UNCLASSIFIED

**SECRET**

b (3)

Doc

~~SECRET~~

UNCLASSIFIED

UNCLASSIFIED

~~SECRET~~

~~SECRET~~

UNCLASSIFIED

b (3)

UNCLASSIFIED

~~SECRET~~

b(3)

~~SECRET~~

UNCLASSIFIED

UNCLASSIFIED

~~SECRET~~

~~SECRET~~ UNCLASSIFIED

✓  
b (3)

UNCLASSIFIED

~~SECRET~~

b (3)

~~SECRET~~  
UNCLASSIFIED

UNCLASSIFIED

~~SECRET~~

b(3)

~~SECRET~~  
UNCLASSIFIED

UNCLASSIFIED  
~~SECRET~~

b (3)

DOE  
10

~~SECRET~~

UNCLASSIFIED

~~SECRET~~  
UNCLASSIFIED



DOE  
b(3)

~~SECRET~~

UNCLASSIFIED

b (3 /

UNCLASSIFIED

~~SECRET~~

b(3)

138

~~SECRET~~

UNCLASSIFIED

UNCLASSIFIED

~~SECRET~~

~~SECRET~~  
UNCLASSIFIED

b (3)

UNCLASSIFIED

~~SECRET~~

b(3)

~~SECRET~~  
UNCLASSIFIED

UNCLASSIFIED

~~SECRET~~

~~SECRET~~ UNCLASSIFIED

b (3)

UNCLASSIFIED

~~SECRET~~

b(3)

~~SECRET~~

UNCLASSIFIED

UNCLASSIFIED

~~SECRET~~

~~SECRET~~

UNCLASSIFIED

UNCLASSIFIED

~~SECRET~~

UNCLASSIFIED  
SECRET

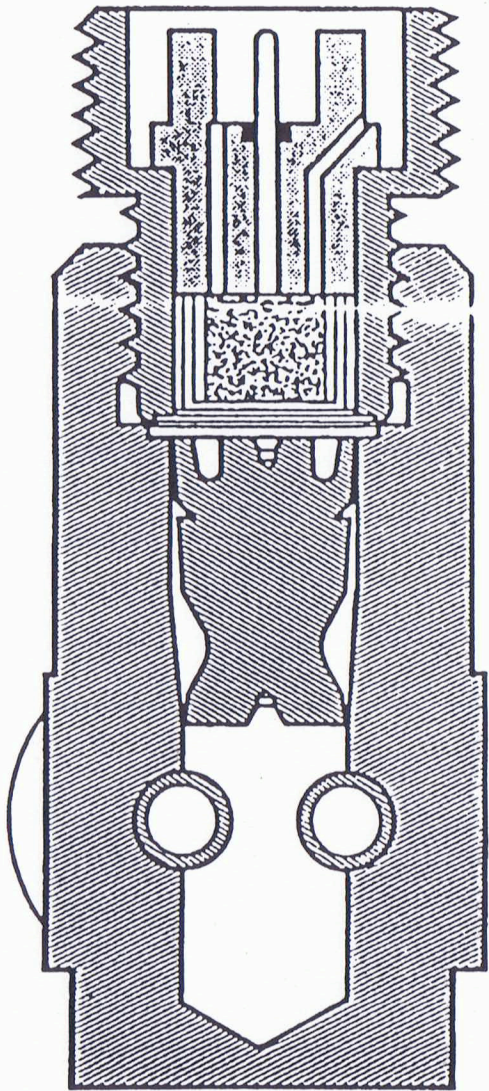

BEFORE

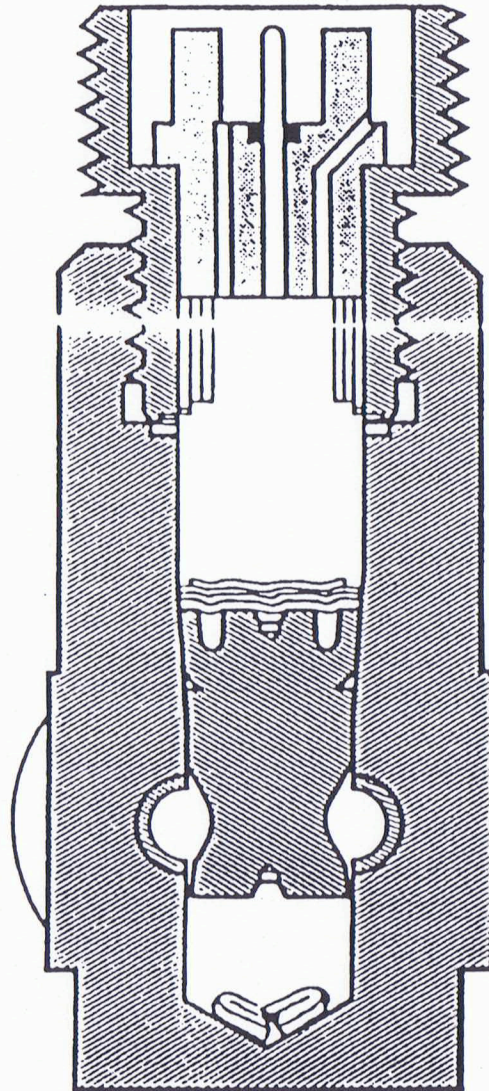

AFTER

EXPLOSIVE VALVE OPERATIONAL SEQUENCE

SECRET UNCLASSIFIED



K 69632  
CLOSURE  
VALVE

BEFORE ACTUATION

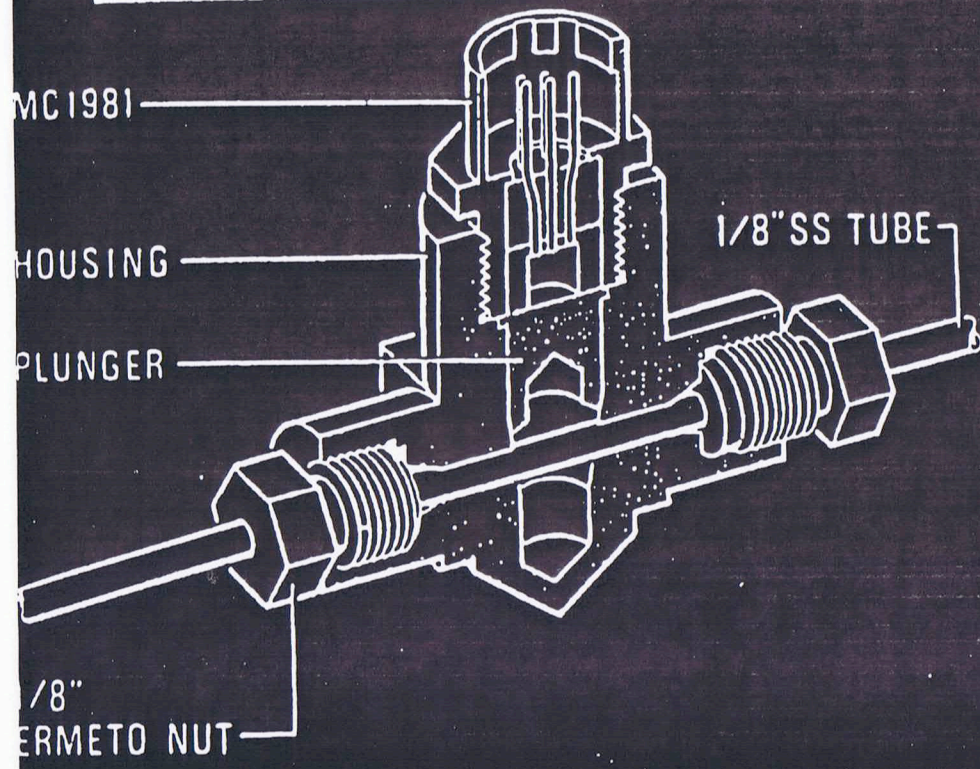

AFTER ACTUATION

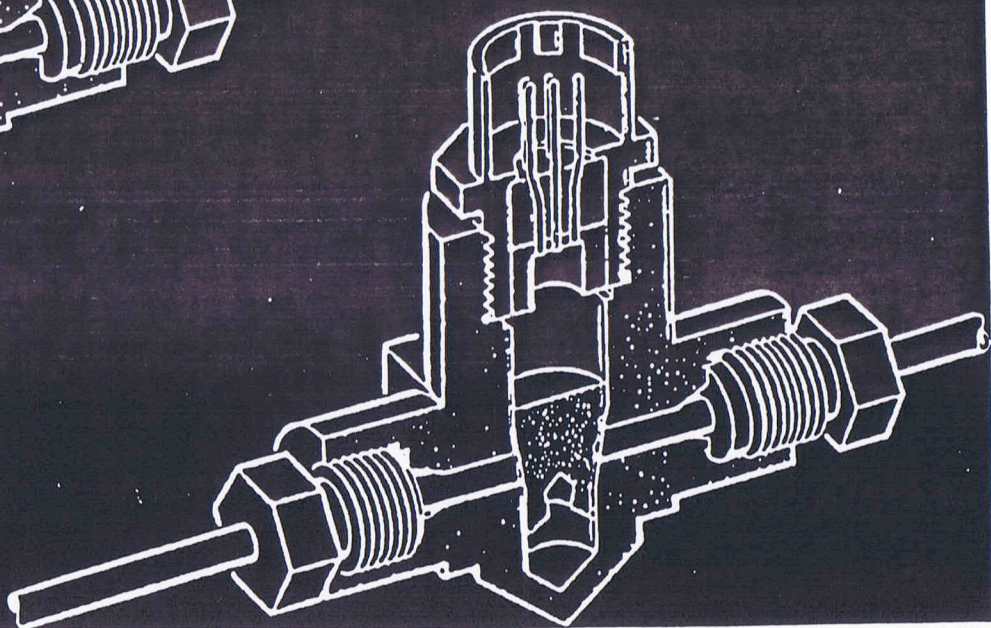

UNCLASSIFIED

UNCLASSIFIED

~~SECRET~~

UNCLASSIFIED

DOE  
b(3)

~~SECRET~~ UNCLASSIFIED

~~SECRET~~ UNCLASSIFIED

DOE  
b(3)

~~SECRET~~ UNCLASSIFIED

b (c)

~~SECRET~~ UNCLASSIFIED

UNCLASSIFIED

~~SECRET~~

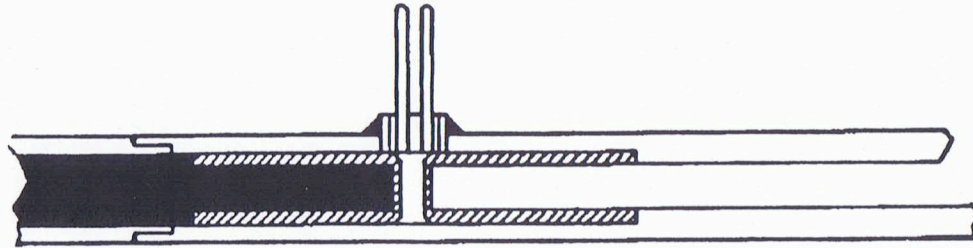

BEFORE

# EXPLODING DISK VALVE OPERATIONAL SEQUENCE

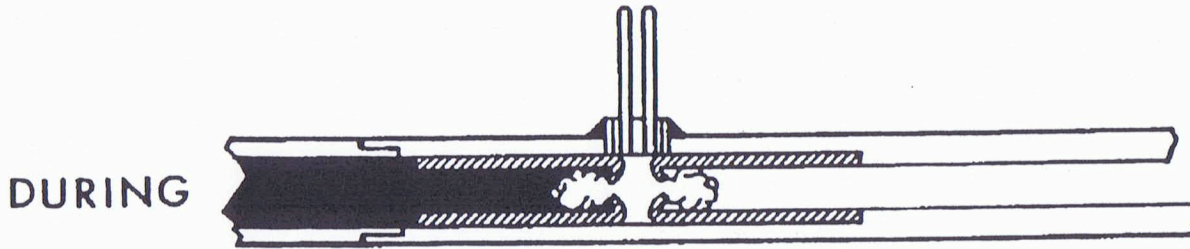

DURING

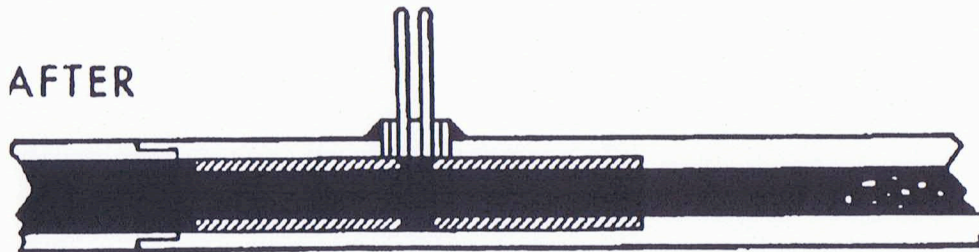

AFTER

~~SECRET~~

UNCLASSIFIED

~~SECRET~~

UNCLASSIFIED

# UNIQUE DESIGN PROBLEMS IN TRITIUM RESERVOIRS (U)

- *System*

- Must Deliver In Specified Time
- Must Be Consistent
- Satisfy Weight And Space Requirements
- Fire And Accident Considerations

- *Long Term Degradation*

- Subject To Hydrogen Embrittlement
- Subject To Helium Embrittlement
- Withstand Pressure Increase With Time
- Subject to Radiation Induced Effects  
(Loss of Permeability, Stoichiometry)

- *Safety*

- Must Be Super Safe Against  
Burst  
Permeation (Walls, Welds, Stringers)

UNCLASSIFIED

UNCLASSIFIED

## Consequences of a stockpile tritium release:

- a. Weapon reliability
- b. Personnel safety
- c. Political/environmental ramifications

~~SECRET~~  
UNCLASSIFIED

~~SECRET~~  
UNCLASSIFIED

~~SECRET~~ UNCLASSIFIED

SECRET

UNCLASSIFIED

*MM*



~~SECRET~~  
UNCLASSIFIED

DOE b(3)

UNCLASSIFIED

~~SECRET~~

# Helium from tritium decay produces cumulative, irreversible damage in stockpile materials

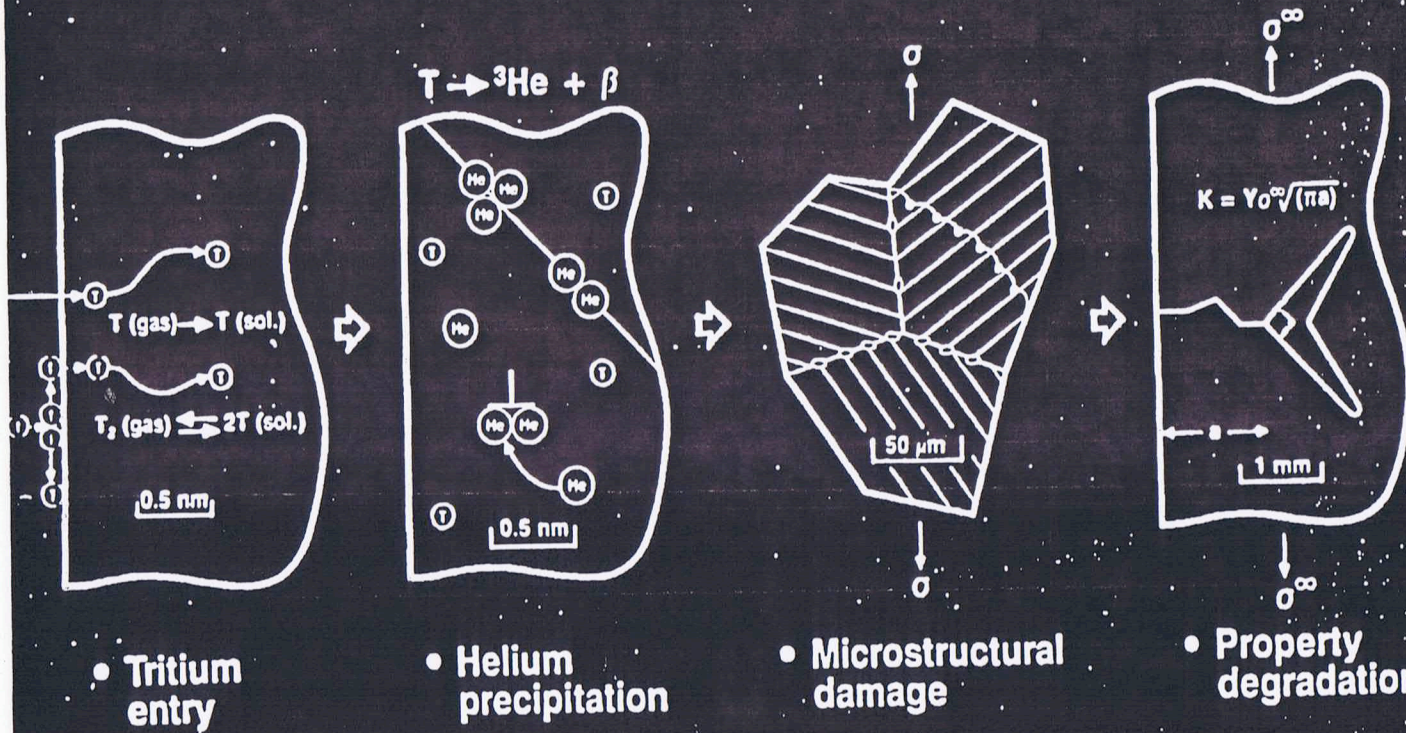

UNCLASSIFIED  
 Atomic

UNCLASSIFIED  
 Atomic

---

## Specifications

- Narrow chemistry——promotes weldability
- Grain size——less than ASTM 5
- Vacuum—arc—remelt (VAR) material
  - Inclusions——ultraclean
  - Ferrete distribution—— < 3% minimize stringers

## Acceptance

- Chemistry
- Metallography
  - Grain size
  - Ferrite distribution
  - Inclusion
- Ultrasonics——porosity

---

For tritium reservoirs, it is necessary to improve the material properties

AWRUC UNCLASSIFIED

AWRUC UNCLASSIFIED

DOE  
b(3)

~~SECRET~~ UNCLASSIFIED

UNCLASSIFIED

~~SECRET~~

~~SECRET~~

DOE  
b(3)

UNCLASSIFIED

UNCLASSIFIED

~~SECRET~~

DOE  
b(3)

~~SECRET~~

UNCLASSIFIED

~~SECRET~~  
UNCLASSIFIED

~~SECRET~~

Doc  
b(3)

UNCLASSIFIED

UNCLASSIFIED

~~SECRET~~

3 (3)

~~SECRET~~  
UNCLASSIFIED

~~SECRET~~  
UNCLASSIFIED



It is most important to clean all surfaces of undesirables

---

## CLEANING

### Why

- To remove residues and oxides which could interface with welding, plating, or heat treating processes
- To remove any metallic materials imbedded into the surfaces permitting the formation of a continuous protective oxide film
- To prevent sources of rusting and corrosion on the surfaces
- To remove contaminants which could react with tritium

### How

- Detergent solutions agitated ultrasonically
- Nitric acid solutions for dissolving imbedded copper and iron particles
- Nitric—hydrofluoric acid solutions for dissolving oxide films and imbedded particulate matter, and to etch certain stainless steel alloys
- Freon and alcohol rinsing for removing organic contaminants
- High purity water for rinsing
- High temperature vacuum bake

---

We take extreme care to verify cleanliness

---

### CLEANLINESS VERIFICATION

- Monitor the resistivity of the rinse water to verify the absence of ionizable material
- Use analytical rinses to check for organic and inorganic contaminants with infrared spectrophotometer and ion chromatography
- Perform particulate analysis on each reservoir
- Check for imbedded iron particles with a copper sulfate test
- Borescopic examination where applicable
- Visual examination for discoloration, staining, or superficial corrosive attack

---

Both piece parts and assemblies are cleaned prior to inspection

~~SECRET~~  
UNCLASSIFIED

~~SECRET~~  
UNCLASSIFIED

Inspection and gaging costs approximate one-third of the piece part costs

---

## INSPECTION AND GAGING

To assure:

- Interchangeability of piece parts
- Fit with next assembly
- Conformation with engineering drawings

We inspect and gage using:

- In process monitoring—feedback
- Open—set up inspection
- Dedicated gages
- Contour gages
- Air gages—non-contact
- Statistical sampling
- Control of numerical machine tapes
- Coordinate measuring machines

---

To minimize scrap and rework costs, we inspect early in the process

ADP/PA UNCLASSIFIED

ADP/PA UNCLASSIFIED

Mechanical joints are not used for storage of tritium

---

ASSEMBLY AND JOINING

Joining:

Weldments

Gas-tungsten arc—autogenous and wire feed

Electron beam—autogenous and wire feed

Laser

Friction

Inertia

Resistance forge weld

Brazes

Copper

Copper-silver-tin

Inspection and Control:

Process monitor

Radiographic

Ultrasonic

Dye Penetrant

---

All pressure rated components are pressure tested

UNCLASSIFIED

UNCLASSIFIED

~~SECRET~~

UNCLASSIFIED

DOE b(3)

UNCLASSIFIED

~~SECRET~~

DOE b(3)

~~SECRET~~

UNCLASSIFIED

UNCLASSIFIED

~~SECRET~~

# PINCH WELDING

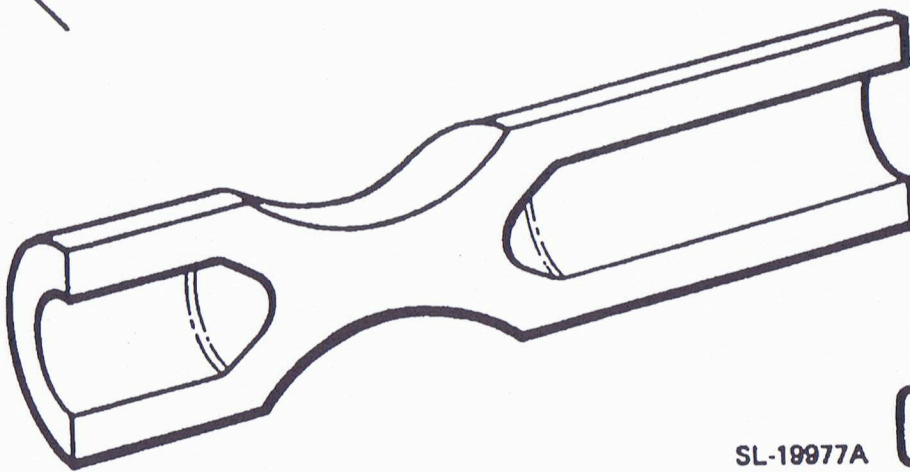
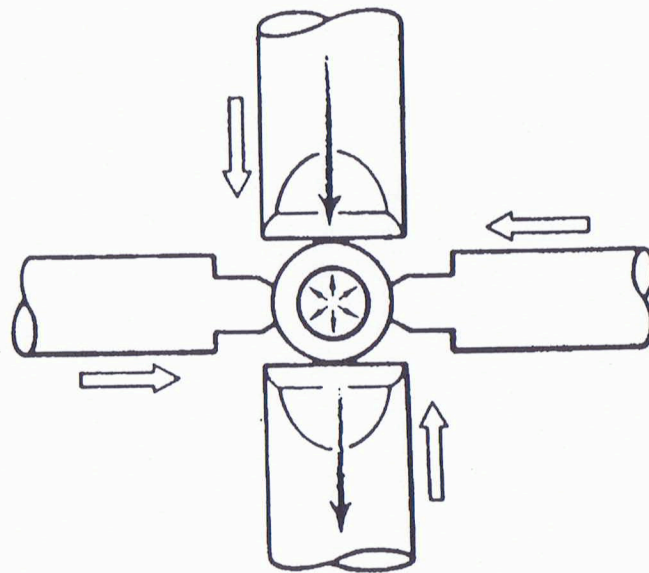
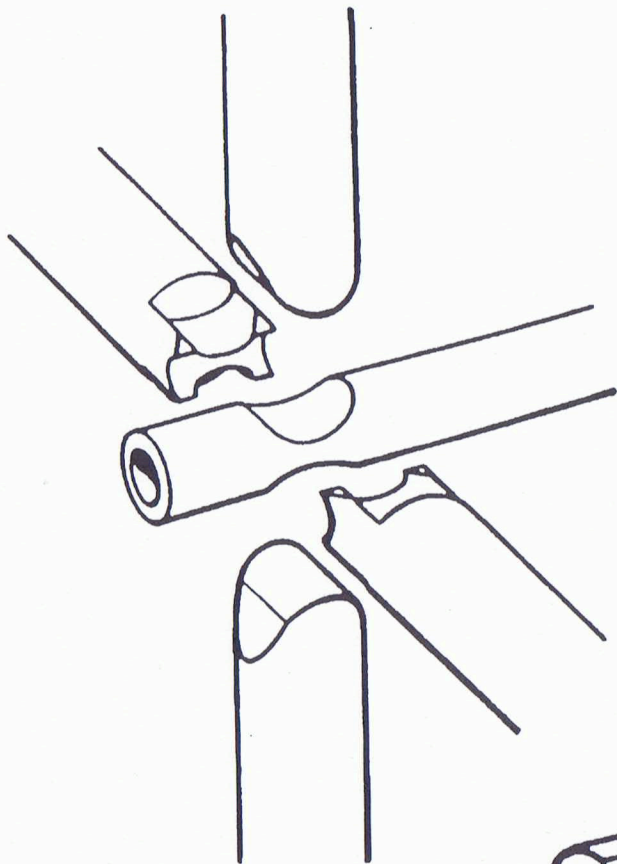

SL-19977A



~~SECRET~~ UNCLASSIFIED

~~SECRET~~ UNCLASSIFIED

b(3)

~~SECRET~~  
UNCLASSIFIED

~~SECRET~~  
UNCLASSIFIED



Crack growth experiments show tritium ( and helium ) to be much more deleterious than hydrogen or deuterium.

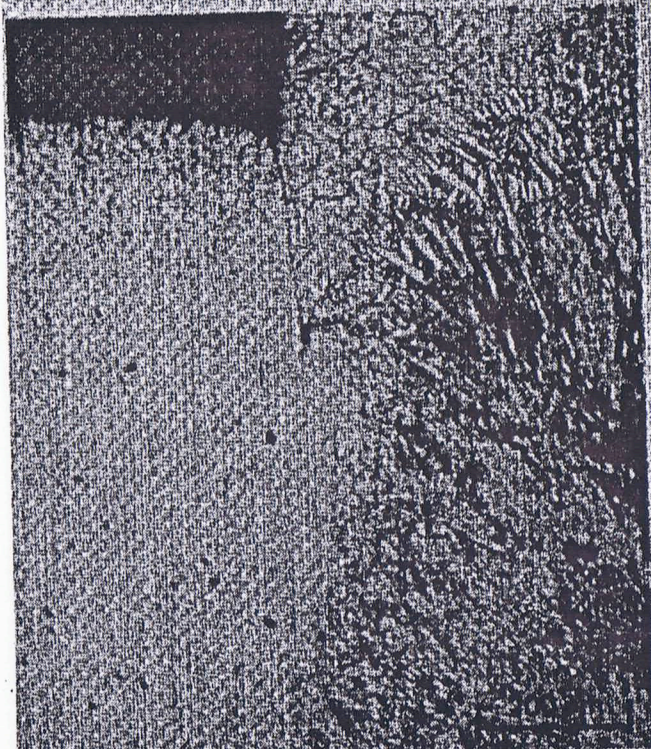

No crack growth is seen in

HYDROGEN

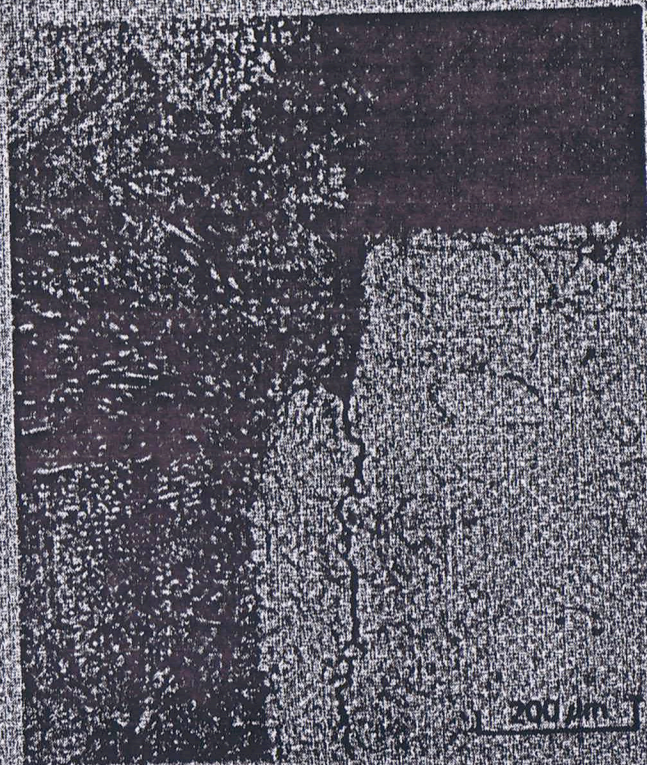

Crack growth is seen in

TRITIUM

ADCPEN UNCLASSIFIED

ADCPEN UNCLASSIFIED

b (3)

~~SECRET~~

UNCLASSIFIED

~~SECRET~~ UNCLASSIFIED

## PRODUCT DEVELOPMENT (U)

### AT SANDIA - R&D

- MATERIALS SELECTION AND TESTING  
SPECIMEN AND STRUCTURAL ANALYSIS
- COMPONENT DESIGN  
DRAWING AND SPECIFICATIONS
- PROTOTYPE DEVELOPMENT  
FABRICATION AND JOINING
- COMPONENT EVALUATION  
STORAGE AND STRUCTURAL TESTING
- SYSTEMS TESTING  
LABORATORY AND FLIGHT TESTS
- PRODUCT DEFINITION

~~SECRET~~  
UNCLASSIFIED

~~SECRET~~  
UNCLASSIFIED

PRODUCT DEVELOPMENT (U)

b (3)

~~SECRET~~

UNCLASSIFIED

~~SECRET~~

UNCLASSIFIED

~~SECRET~~

UNCLASSIFIED

b(3)

UNCLASSIFIED

~~SECRET~~

---

**WE HAVE NO REASON TO ASSUME WE FOUND  
ALL THE TRITIUM SURPRISES**

**It is not possible to extrapolate with  
adequate confidence, tritium effects on components**

---

~~SECRET~~  
UNCLASIFIED

~~SECRET~~  
UNCLASIFIED

# SURVEY OF WEAPONS DEVELOPMENT AND TECHNOLOGY

WR708

## SESSION XIV

- RADAR FUZING TECHNOLOGY
- OTHER FUZING MODES
- ADVANCED FUZING CONCEPTS

ED

~~SECRET~~  
UNCLASSIFIED

~~SECRET~~  
UNCLASSIFIED

## Nuclear Weapon Fuzing Technology

- Introduction to Fuzing Components & Systems
- Radar Fuzing
- Contact Fuzing
- Inertial, Barometric, and Timer Fuzes
- Fuzing Systems
- **Future** Fuzing Systems
  - SLBM Warhead Protection Program

~~SECRET~~  
UNCLASSIFIED

~~SECRET~~  
UNCLASSIFIED



## What is a Fuze ?

- Mechanism(s) within a weapon responsible for optimizing the location of weapon detonation
- Initiates the final, irreversible phase of weapon detonation
  - Follows “arming” functions, which are
    - reversible
    - time-uncritical
  - Precedes “firing”

~~SECRET~~  
UNCLASSIFIED

~~SECRET~~  
UNCLASSIFIED

SECRET UNCLASSIFIED

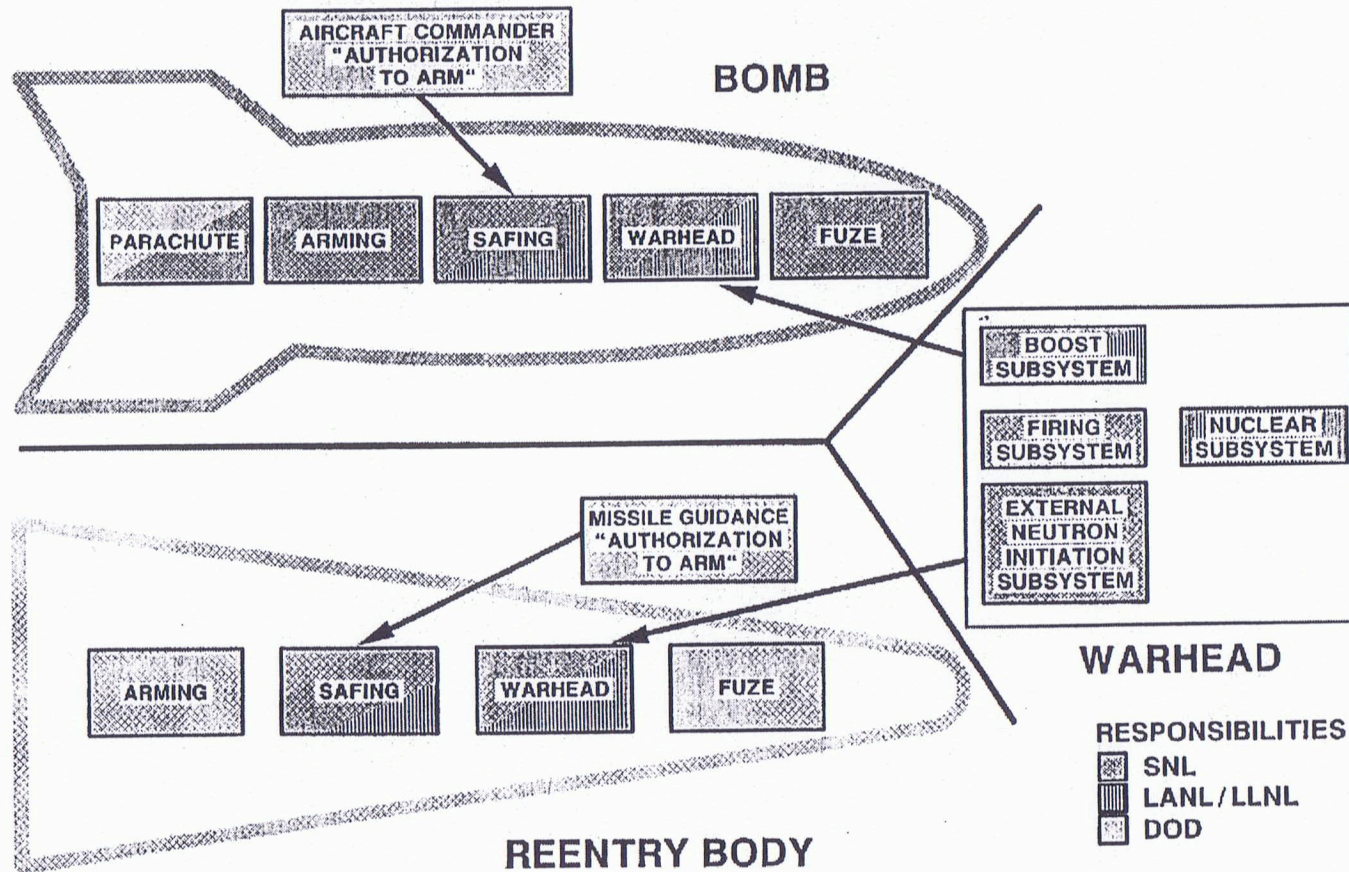

TA400.56

SECRET UNCLASSIFIED

# Fuzing System Hierarchy

---

## Components:

Radars  
(Antennas)

Clocks

G-switches

Pressure sensors  
(Baro/hydro)

Accelerometers

Programmiers

Crush sensors

~~SECRET~~

UNCLASSIFIED

~~SECRET~~

UNCLASSIFIED

## Fuzing System Hierarchy

---

### Components:

Radars  
(Antennas)

Clocks

G-switches

Pressure sensors  
(Baro/hydro)

Accelerometers

Programmiers

Crush sensors

### Sub-Systems:

Airburst radars

Proximity radars  
(prox time-down)

Timers

G-started timers

Pressure-started  
timers

G-started integrating  
accelerometers (FBIAs)

Path length

Radar-Updated Path  
Length (RUPL)

Impact fuzes

~~SECRET~~  
UNCLASSIFIED

~~SECRET~~  
UNCLASSIFIED

# Fuzing System Hierarchy

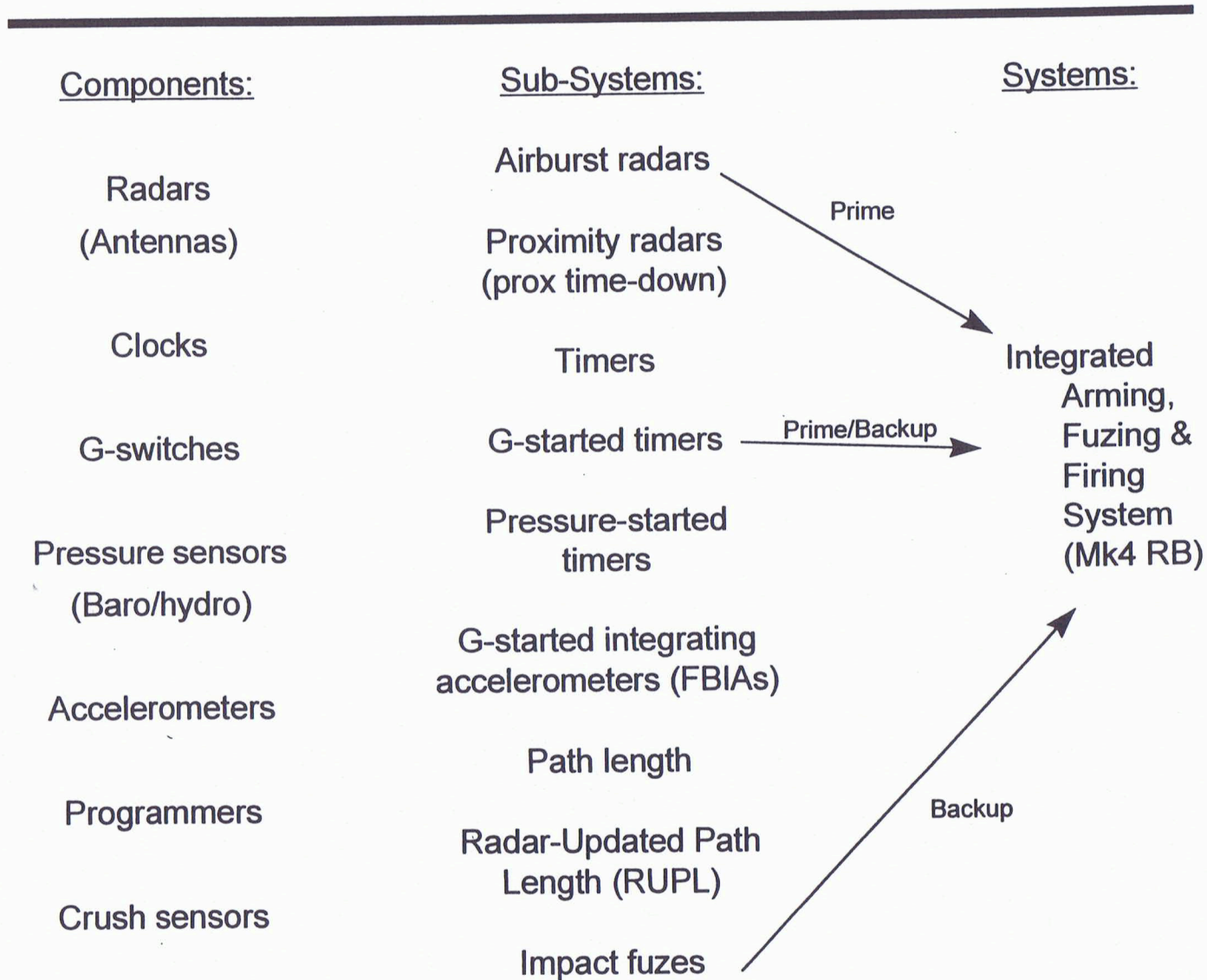

REF ID: A66666 UNCLASSIFIED

REF ID: A66666 UNCLASSIFIED

# Fuzing System Hierarchy

Components:

- Radars  
(Antennas)
- Clocks
- G-switches
- Pressure sensors  
(Baro/hydro)
- Accelerometers
- Programmings
- Crush sensors

Sub-Systems:

- Airburst radars
- Proximity radars  
(prox time-down)
- Timers
- G-started timers
- Pressure-started  
timers
- G-started integrating  
accelerometers
- Path length
- Radar-Updated Path  
Length (RUPL)
- Impact fuzes

Systems:

Integrated  
Arming,  
Fuzing &  
Firing  
System  
(Mk5 RB)

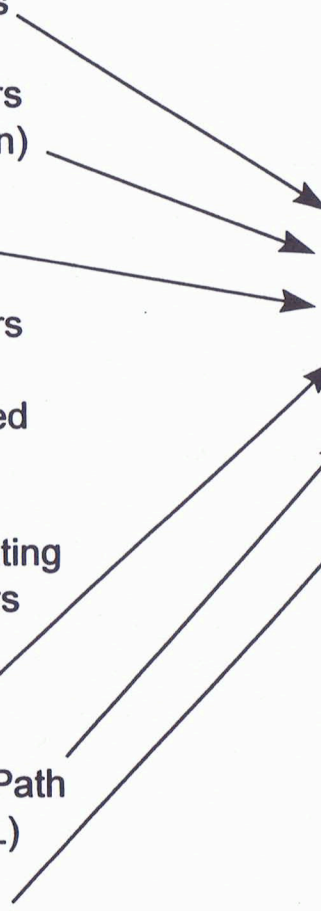

UNCLASSIFIED

UNCLASSIFIED

# How is a Fuze selected?

---

Traditional fuzing system priorities:

- Reliable
- Light weight (reentry body)
- Accurate
- Small (reentry body)
- Flexible
- Testable
- Producing
- Inexpensive

~~SECRET~~  
UNCLASSIFIED

~~SECRET~~  
UNCLASSIFIED

## How is a Fuze selected?

---

*Future* fuzing systems must be:

- Inexpensive
- Producible
- Reliable
- Accurate
- Certifiable (test & analysis)
- Flexible
- Small (reentry body)
- Light weight (reentry body)

~~SECRET~~  
UNCLASSIFIED

~~SECRET~~  
UNCLASSIFIED



# Radar Fuzing

---

- Role of radar fuzing
- Basic radar fuze operation
- Radar design issues
- Current technology

~~SECRET~~  
UNCLASSIFIED

~~SECRET~~  
UNCLASSIFIED

## Why use a radar ?

---

- Height of burst precision to maximize extent of low overpressure levels
  - setability
  - accuracy
- Height of burst control to minimize fallout
- Dependable surface fuzing
  - Ensure detonation prior to collision
- Accurate altitude reference for improving inertial fuze accuracy (radar-updated path length fuze)

~~SECRET~~

UNCLASSIFIED

~~SECRET~~

UNCLASSIFIED

# PEAK OVERPRESSURES ON THE GROUND FOR A 1-KILOTON BURST

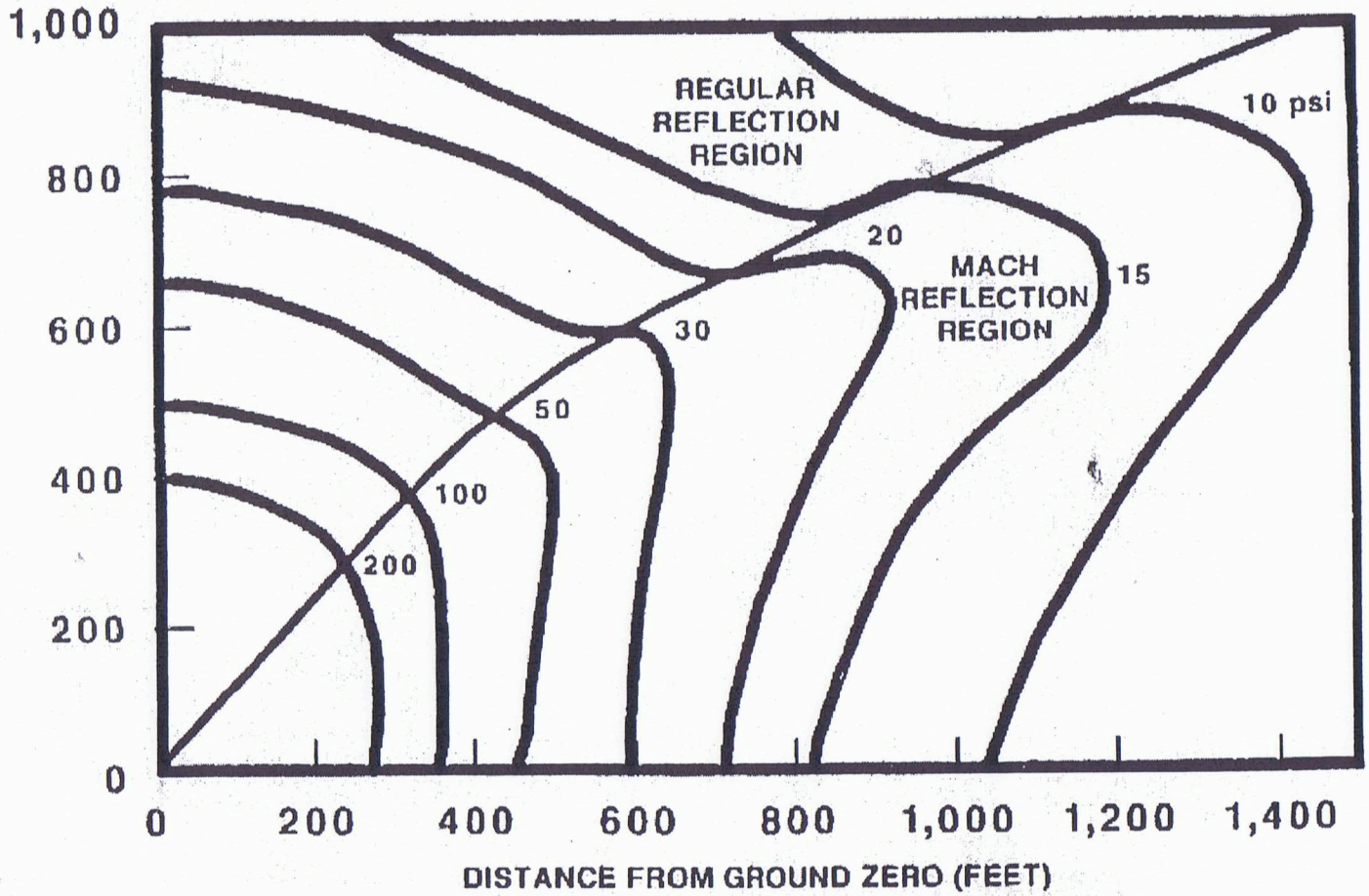

REFERENCE: GLASSTONE AND DOLAN, THE EFFECTS  
OF NUCLEAR WEAPONS, 3RD EDITION US DOD AND DOE, 1977

UNCLASSIFIED

UNCLASSIFIED

# Basic Radar Operation

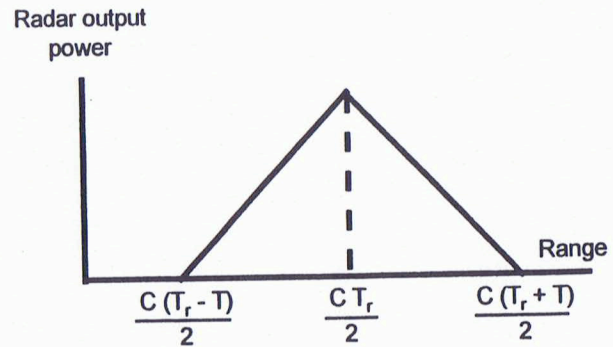
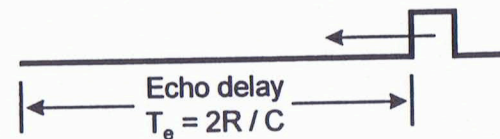
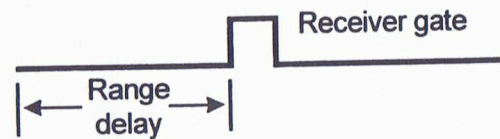
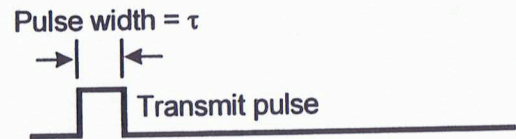
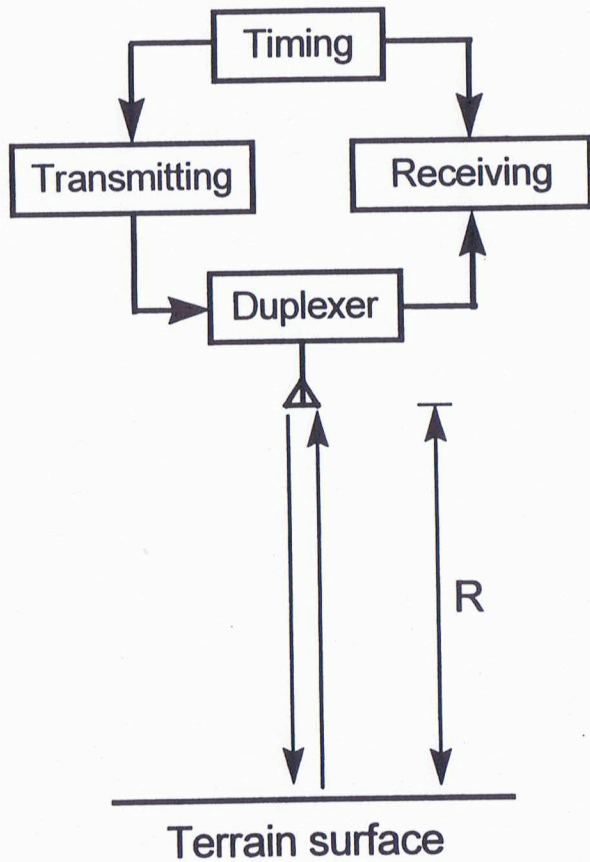

UNCLASSIFIED

UNCLASSIFIED

# Radar design considerations

---

- Immunity to electronic countermeasures
  - prevent premature detection of “radar-like” signals (“spoofing”)
  - ensure detection of radar return in presence of RF energy saturation (“dudding”)
- Plasma loss (space shuttle “black-out”)
  - affects both transmit *and* receive
  - varies with: velocity  
altitude  
nosetip and heat shield materials

~~SECRET~~

UNCLASSIFIED

~~SECRET~~

UNCLASSIFIED

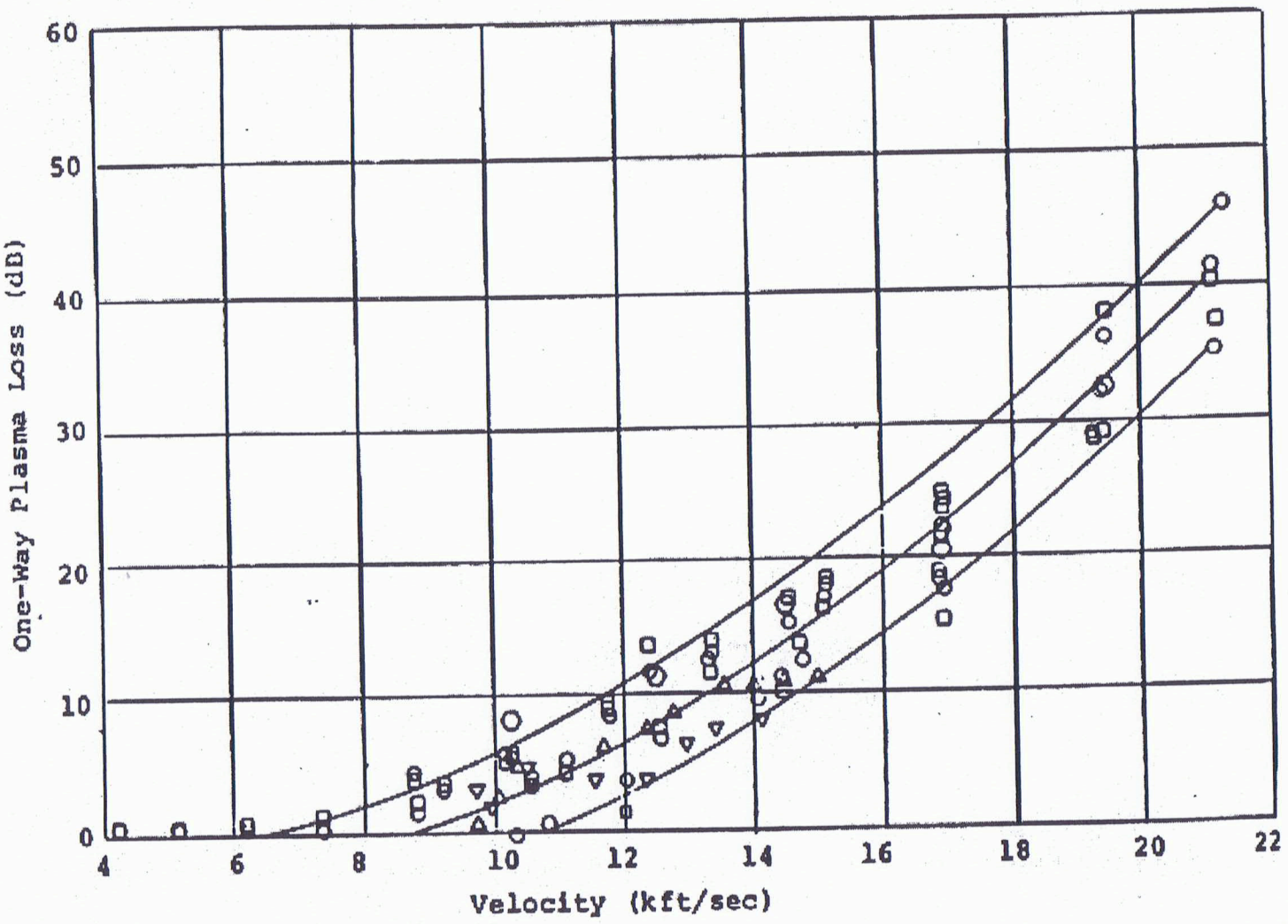

~~SECRET~~

UNCLASSIFIED

~~SECRET~~  
UNCLASSIFIED

# One-way plasma loss vs. frequency for ABRV-3 trajectory

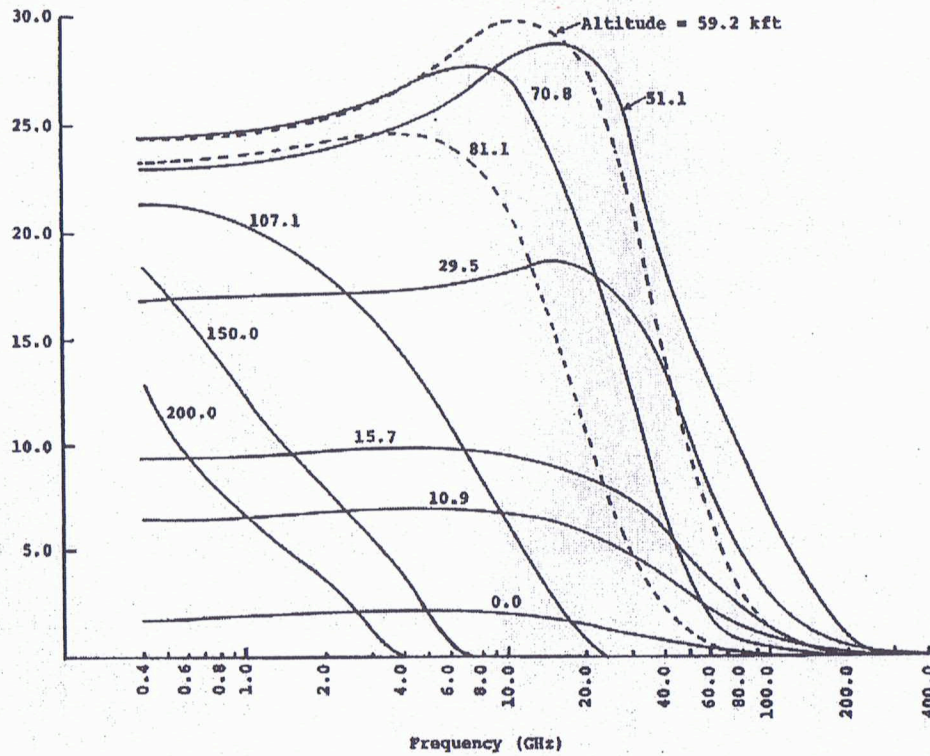

SECRET

UNCLASSIFIED

SECRET

UNCLASSIFIED

## Radar design considerations, cont'd

---

- Antenna gain patterns
  - affects both transmit *and* receive
  - must accommodate all flight path angles and roll orientations
- Target reflectivities
  - peak reflectivity & angular attenuation
- Frequency
  - Higher frequencies required for proximity fuze narrow pulse width
  - Higher frequencies require less "real estate" for antenna windows
    - Smaller antennas thought to have less impact on reentry body flight
  - Lower frequencies have lower "path loss" requiring less receiver loop sensitivity

~~SECRET~~

UNCLASSIFIED

~~SECRET~~

UNCLASSIFIED



~~SECRET~~

UNCLASSIFIED

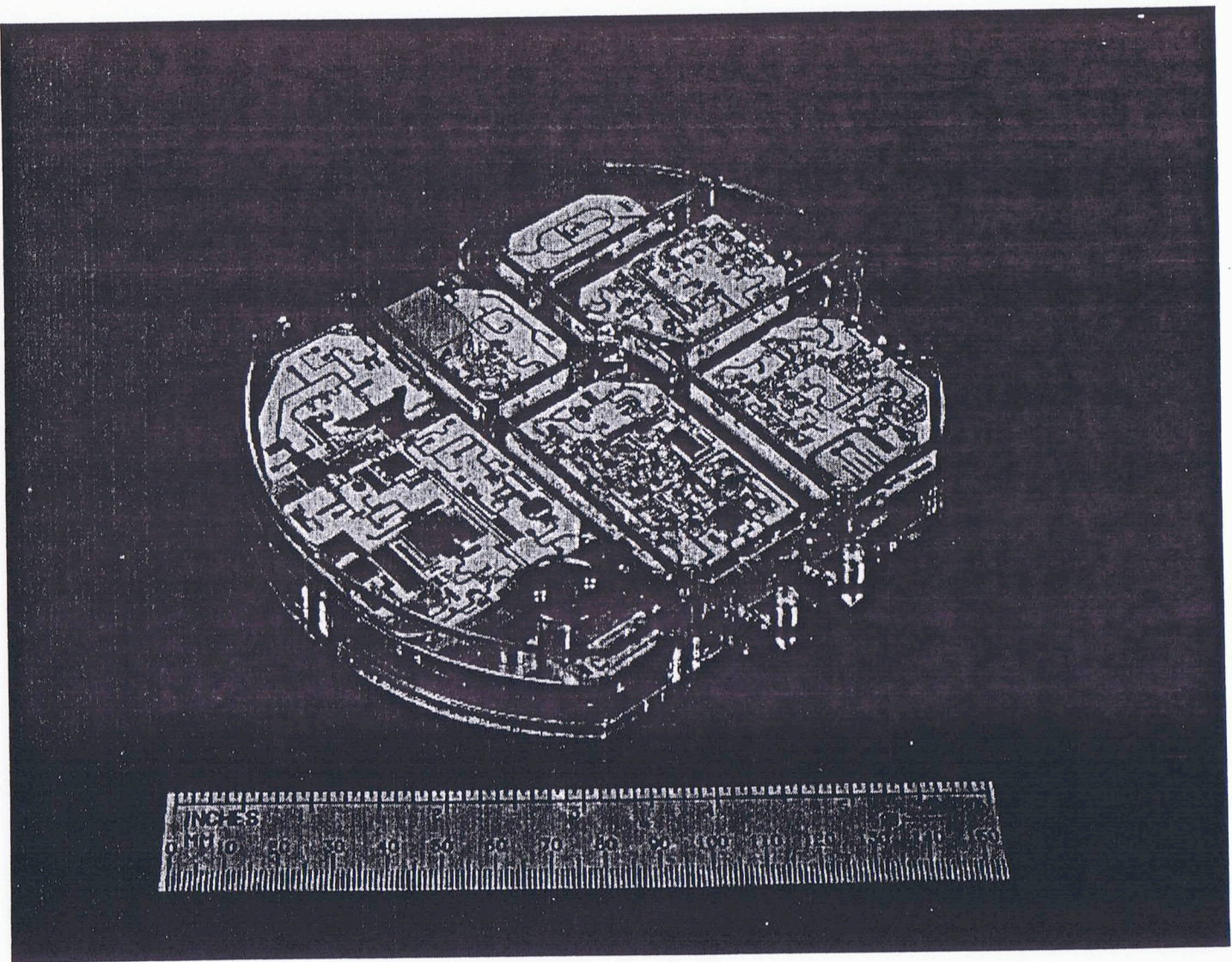

UNCLASIFIED

~~SECRET~~

~~SECRET~~

UNCLASSIFIED

~~SECRET~~

UNCLASSIFIED

~~SECRET~~ UNCLASSIFIED

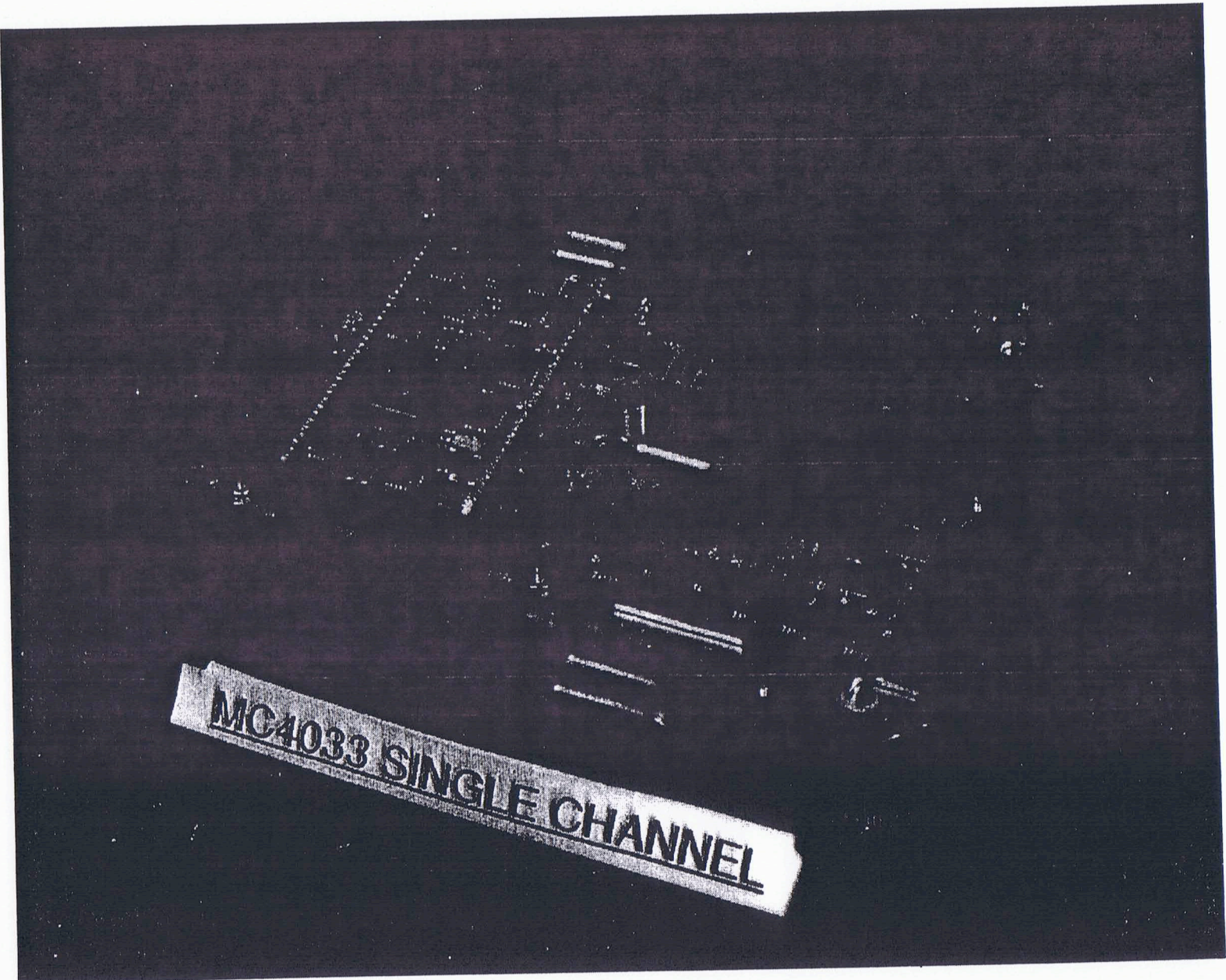

~~SECRET~~ UNCLASSIFIED

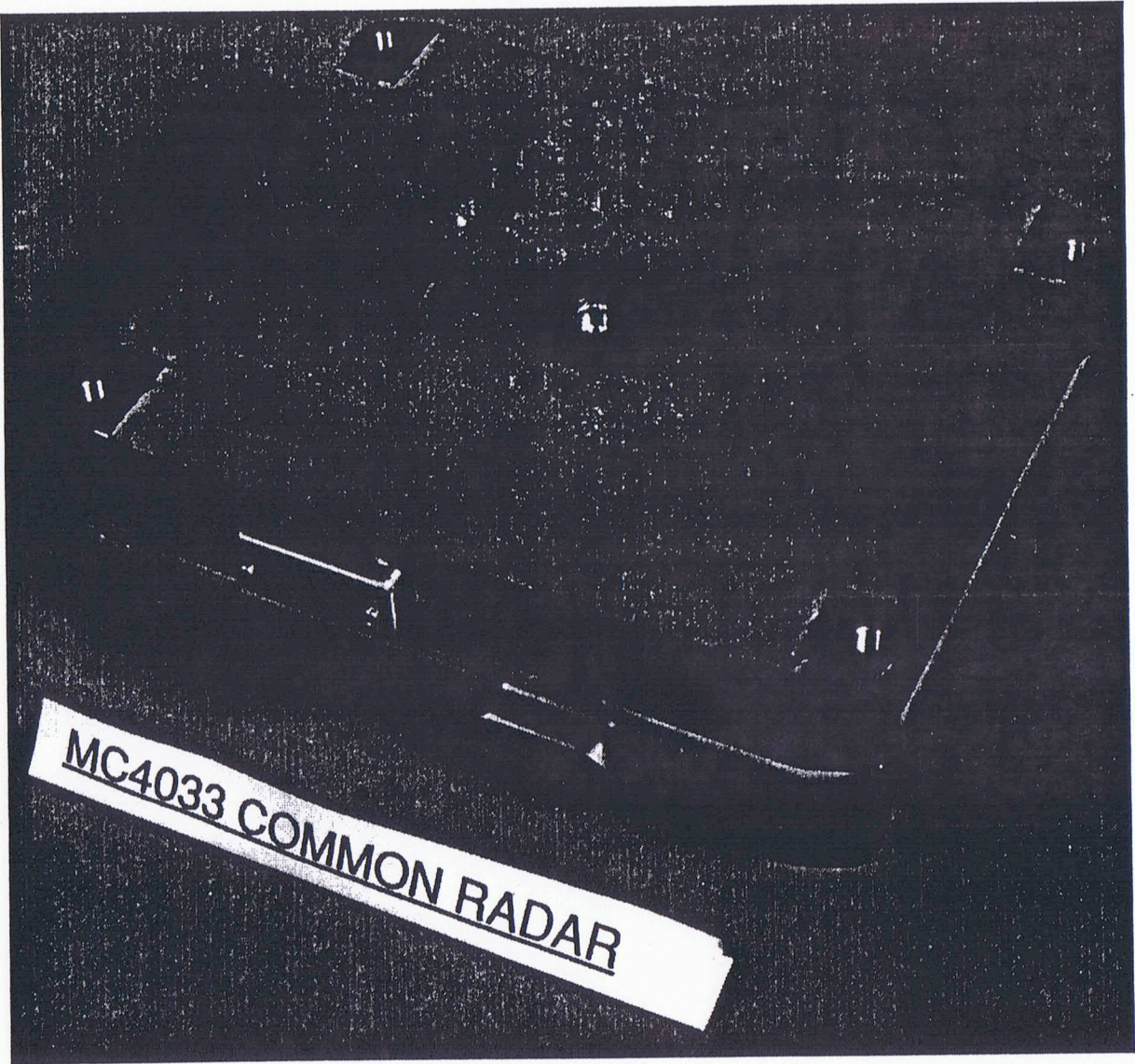

~~SECRET~~ UNCLASSIFIED

~~SECRET~~ UNCLASSIFIED

~~ARMY~~ UNCLASSIFIED

b(3)

~~ARMY~~ UNCLASSIFIED

b (3)

ONE  
BY

~~SECRET~~  
UNCLASSIFIED

UNCLASSIFIED

~~SECRET~~

# Sandia Fuze Development & Production (1965 - 2010)

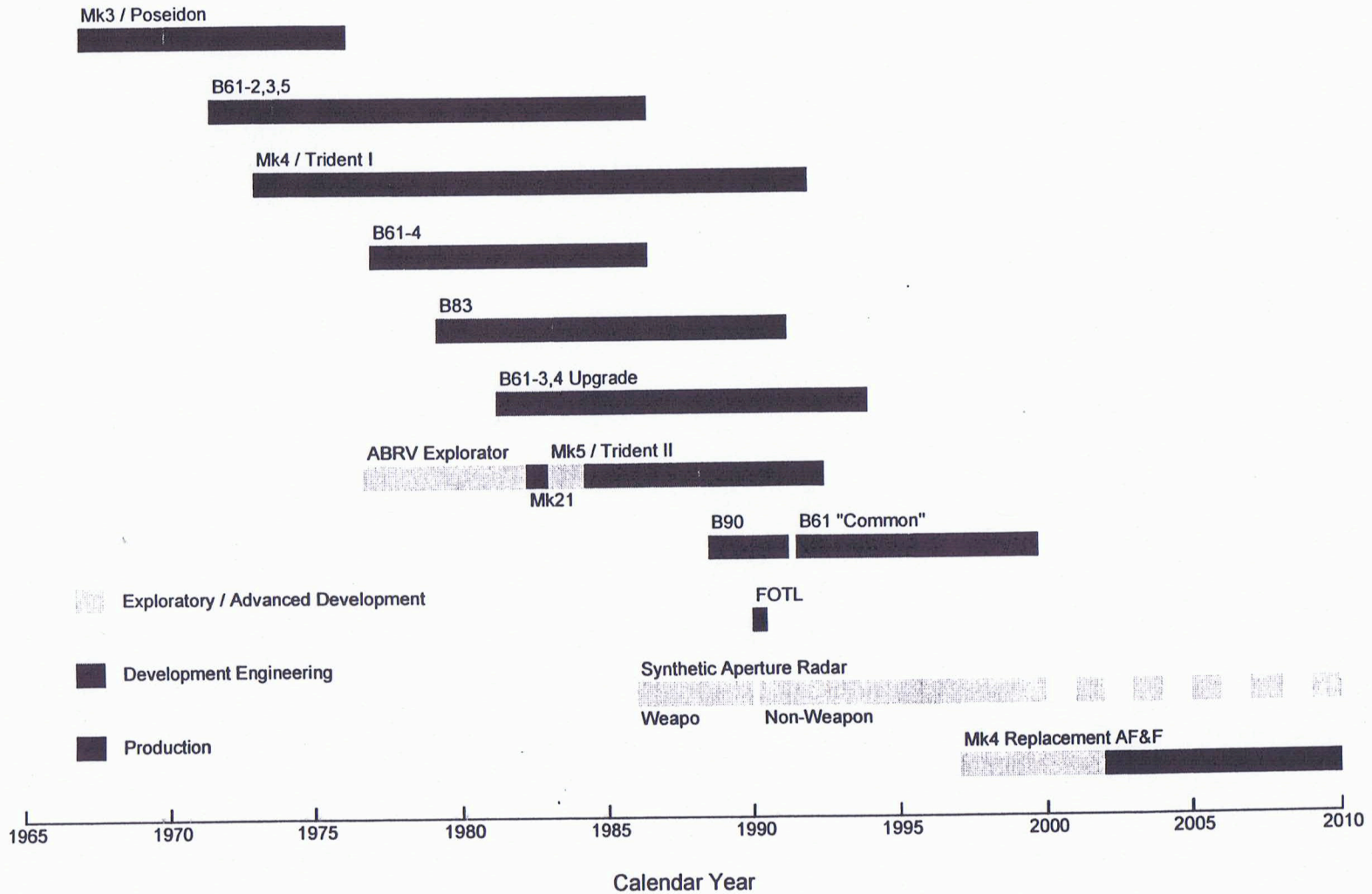

UNCLASSIFIED

UNCLASSIFIED

# Contact Fuzing

~~SECRET~~  
UNCLASSIFIED

~~SECRET~~  
UNCLASSIFIED



## Contact fuze characteristics

---

- Output directly triggers firing set for fast operation

OR

initiates delay mechanism for weapon designed for impact survivability

- Piezoelectric materials release charge (voltage) when shocked
  - generally not requiring external “poling” or charging
- Use pervasively throughout the stockpile for both selectable and backup fuzing

~~SECRET~~

UNCLASSIFIED

~~SECRET~~

UNCLASSIFIED

# MC3549 IMPACT SENSOR

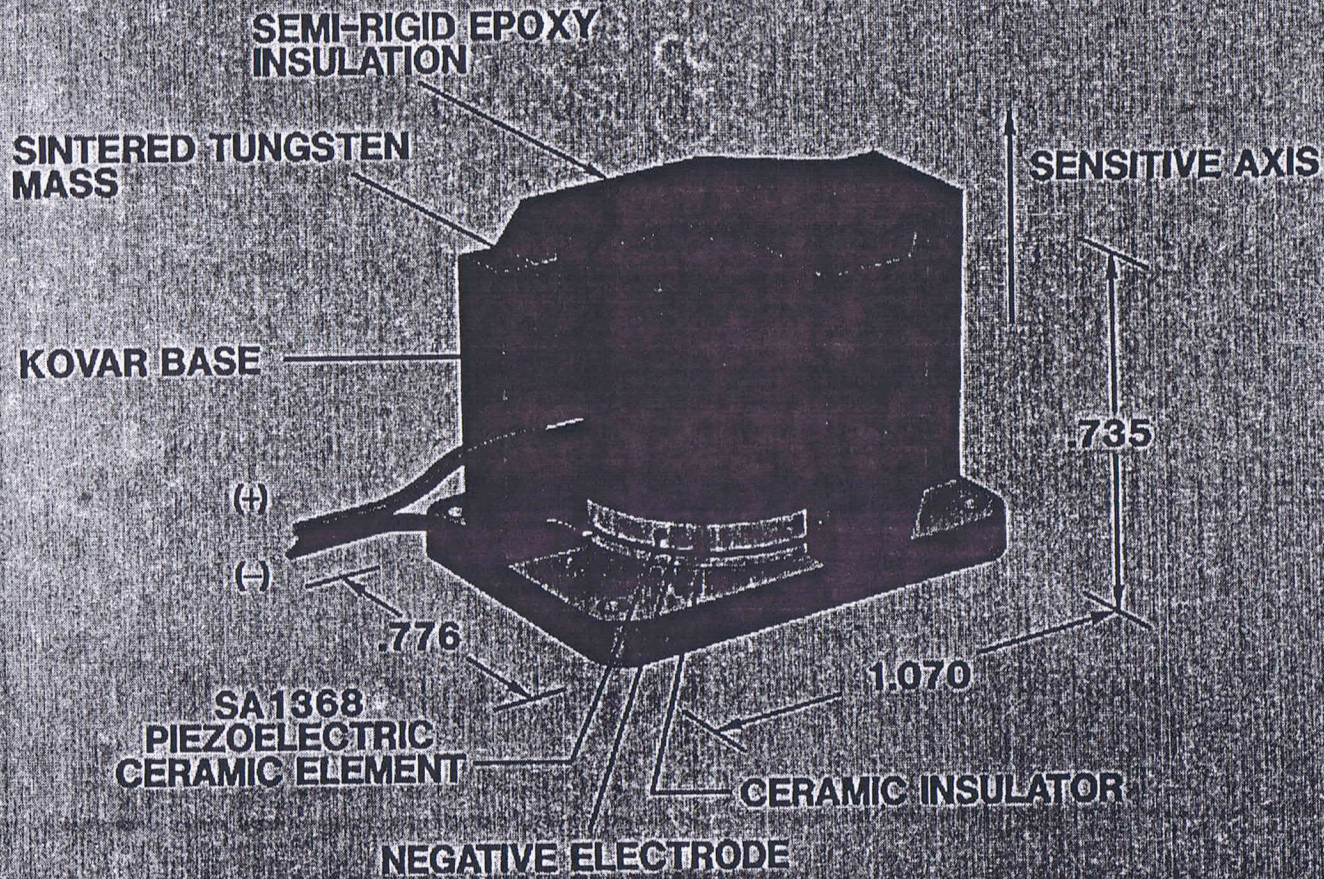

UNCLASSIFIED

UNCLASSIFIED

~~SECRET~~

UNCLASSIFIED

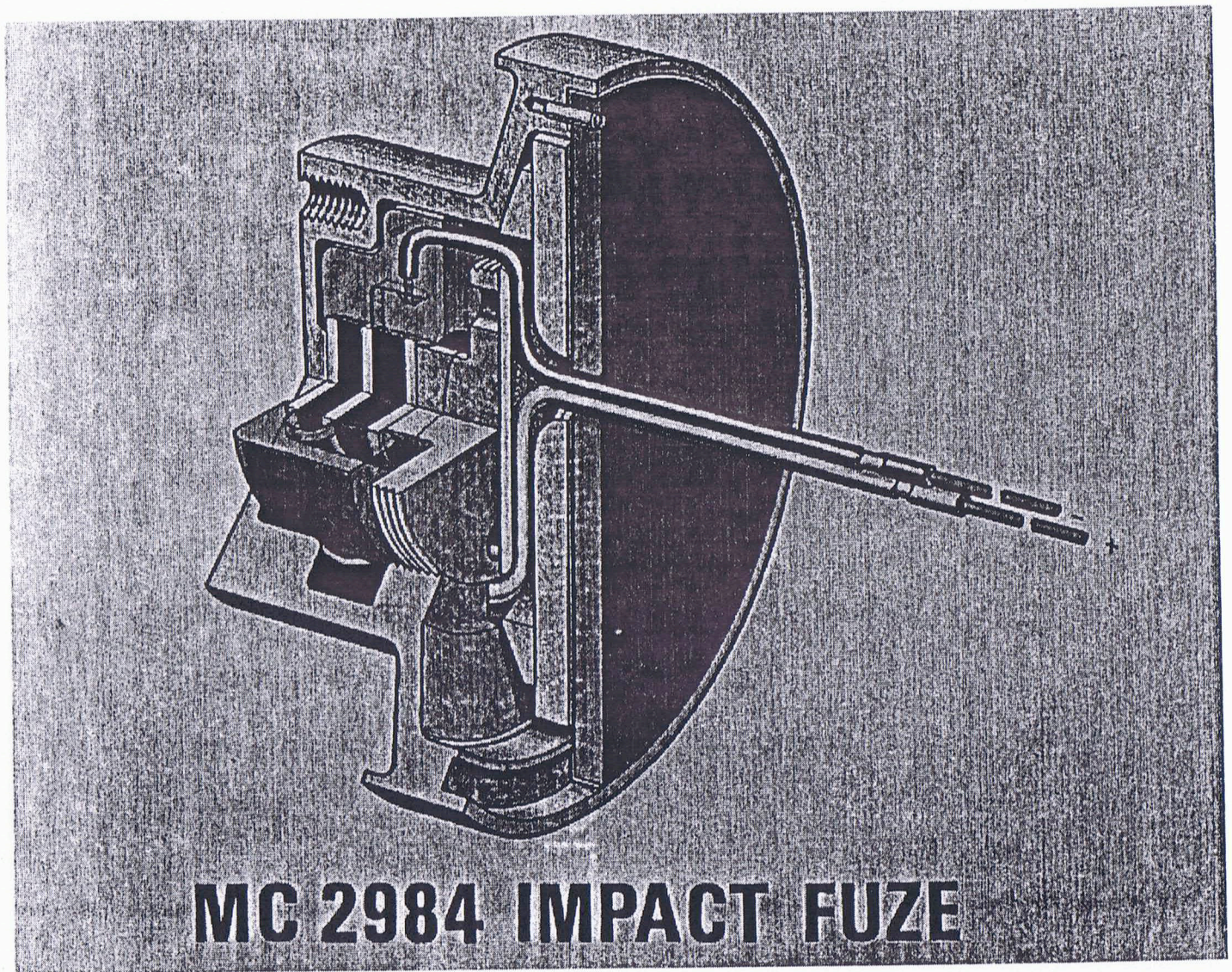

**MC 2984 IMPACT FUZE**

UNCLASSIFIED

~~SECRET~~

## Contact Fuze Characteristics

---

- Advantages
  - Very little penalty in weight, cost or volume
  - Desirable as backup to air burst fuzing
  - Radiation hardened and immune to jamming
  - Very reliable as a component
  - Maximizes crater volume and ground motion in comparison to other air burst options
- Disadvantages
  - Reduced "effects radius" for air burst targets
  - Range offset associated with backup role
  - Qualification / testing has been costly
  - Dependability concerns (system reliability)

~~SECRET~~

UNCLASSIFIED

~~SECRET~~

UNCLASSIFIED

## Contact fuzing degree of difficulty

---

	Component	System
Design	Easy	Easy
Validate	Fairly easy	Very difficult

~~SECRET~~

UNCLASSIFIED

~~SECRET~~

UNCLASSIFIED

# Contact vs. Proximity - Ground shock environments

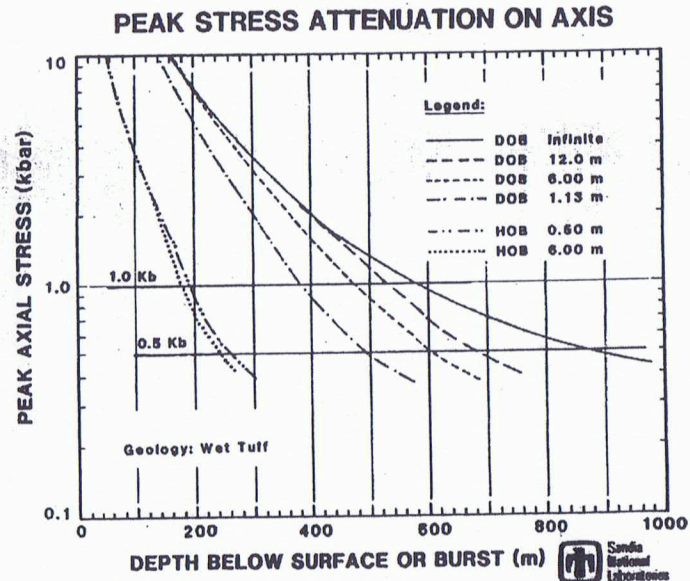
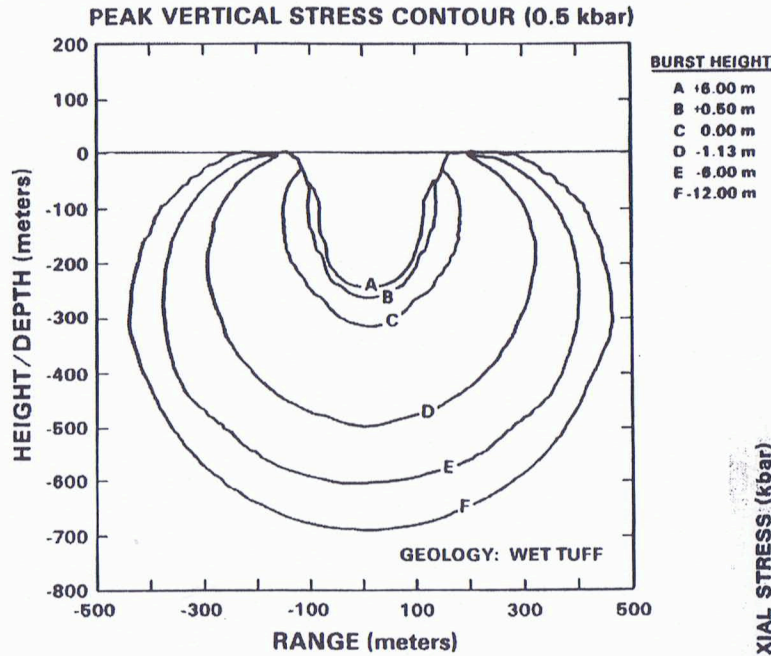

Proximity fuzing consistently results in minimal degradation in ground shock environments when compared to contact

SECRET

UNCLASSIFIED

SECRET UNCLASSIFIED

b(3)

ONE  
10

~~SECRET~~

UNCLASSIFIED

~~SECRET~~

UNCLASSIFIED

~~SECRET~~ UNCLASSIFIED

UNCLASSIFIED

~~SECRET~~



~~SECRET~~ UNCLASSIFIED

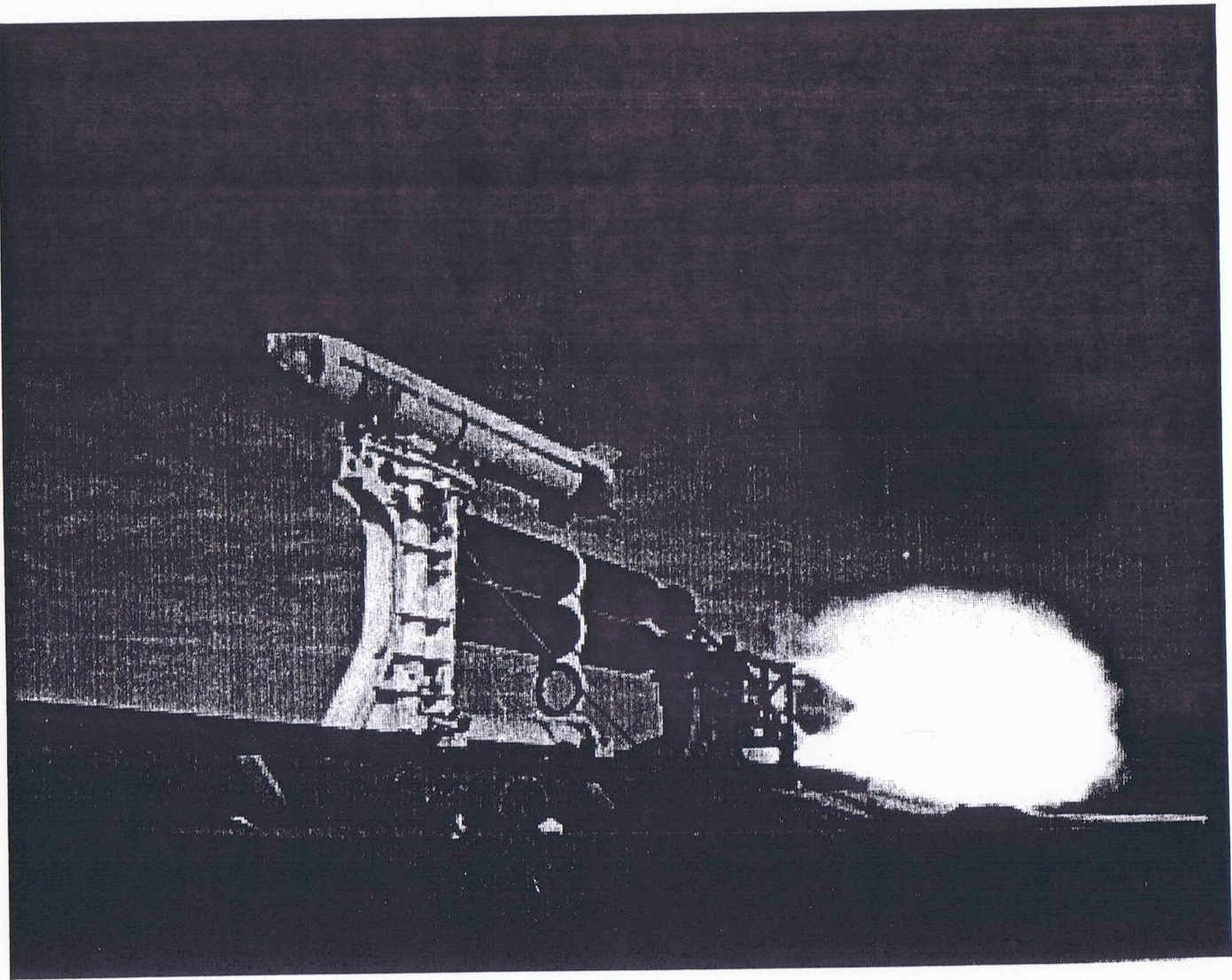

UNCLASSIFIED

~~SECRET~~

Figure 29

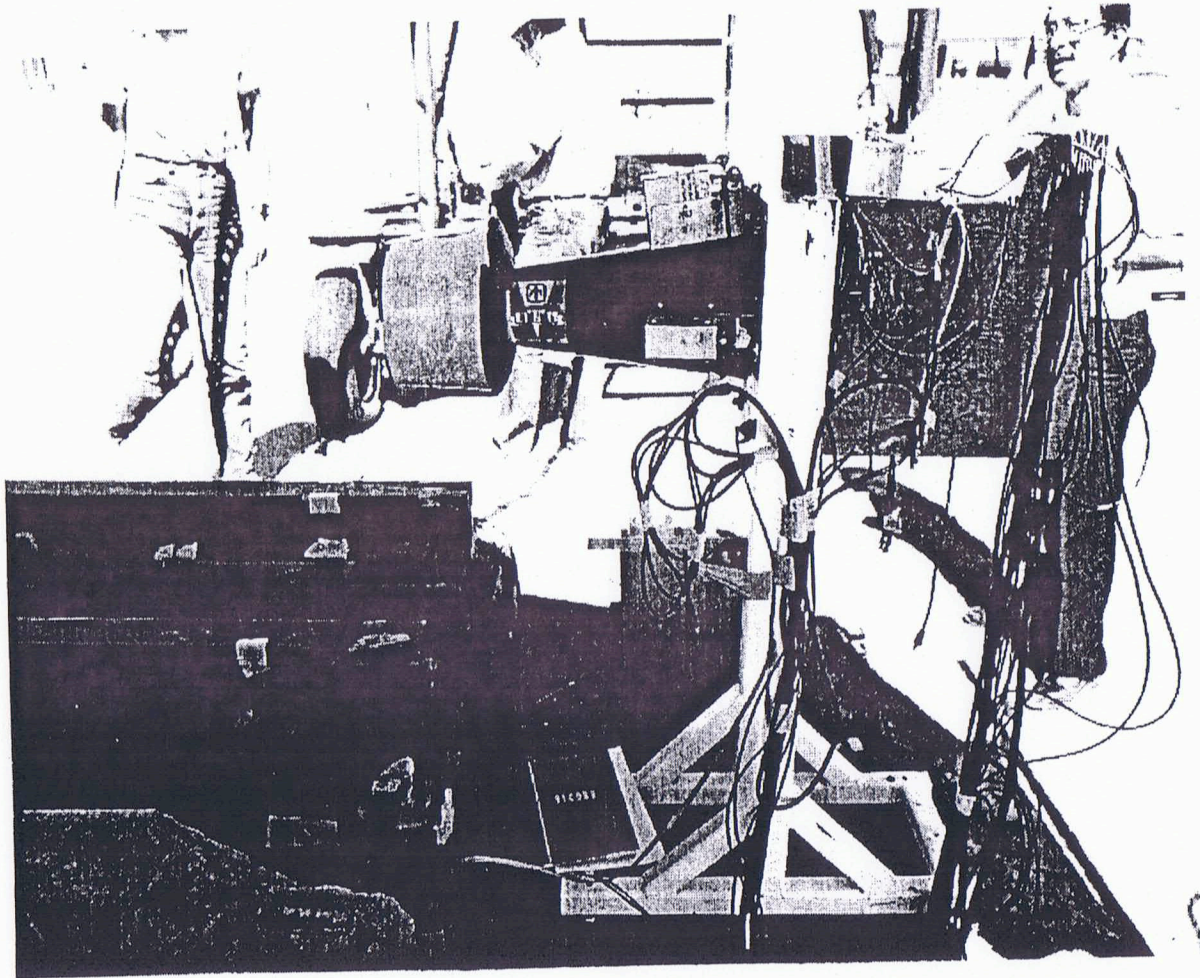

~~SECRET~~  
UNCLASSIFIED

~~SECRET~~  
UNCLASSIFIED

~~SECRET~~ UNCLASSIFIED

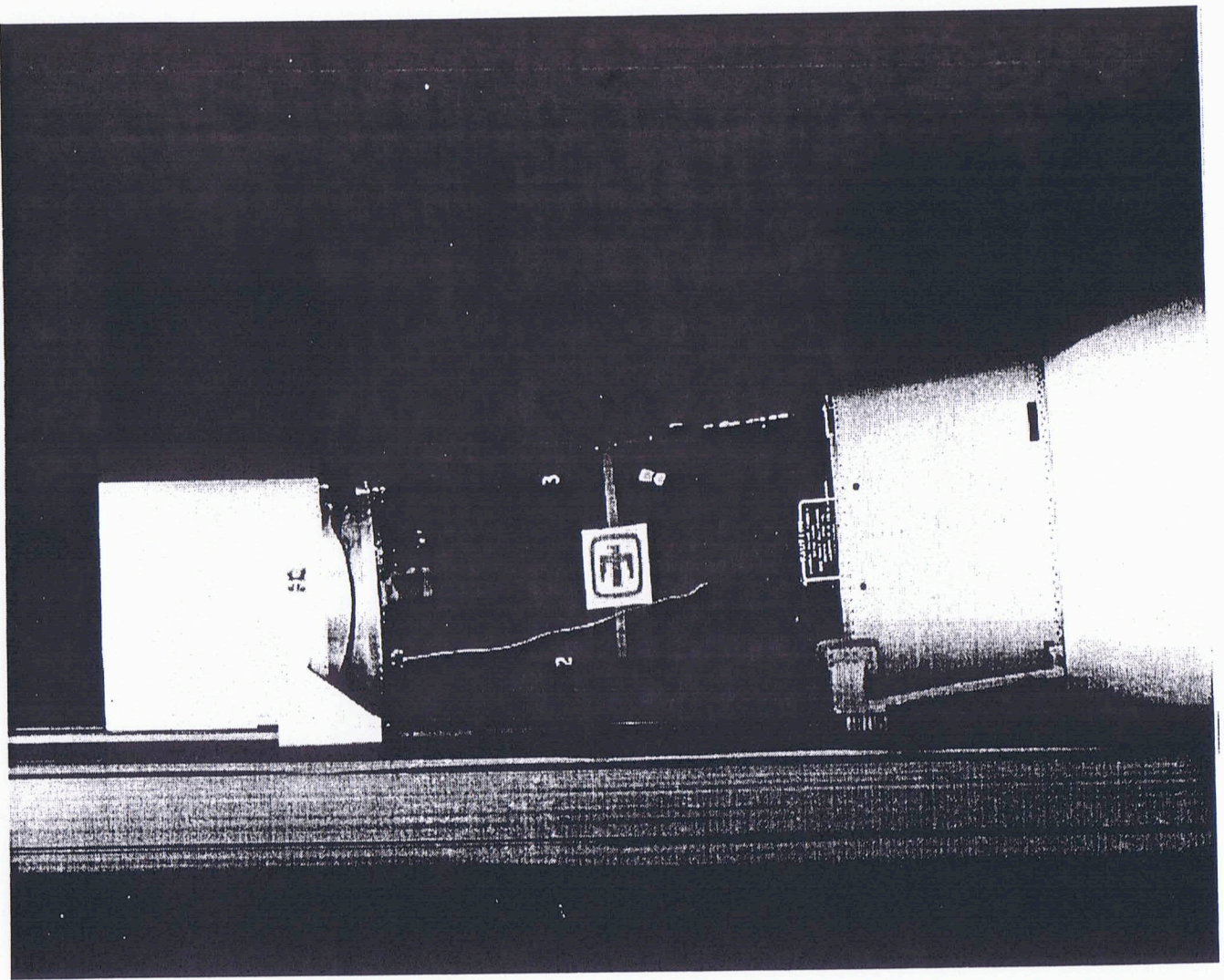

UNCLASSIFIED

~~SECRET~~

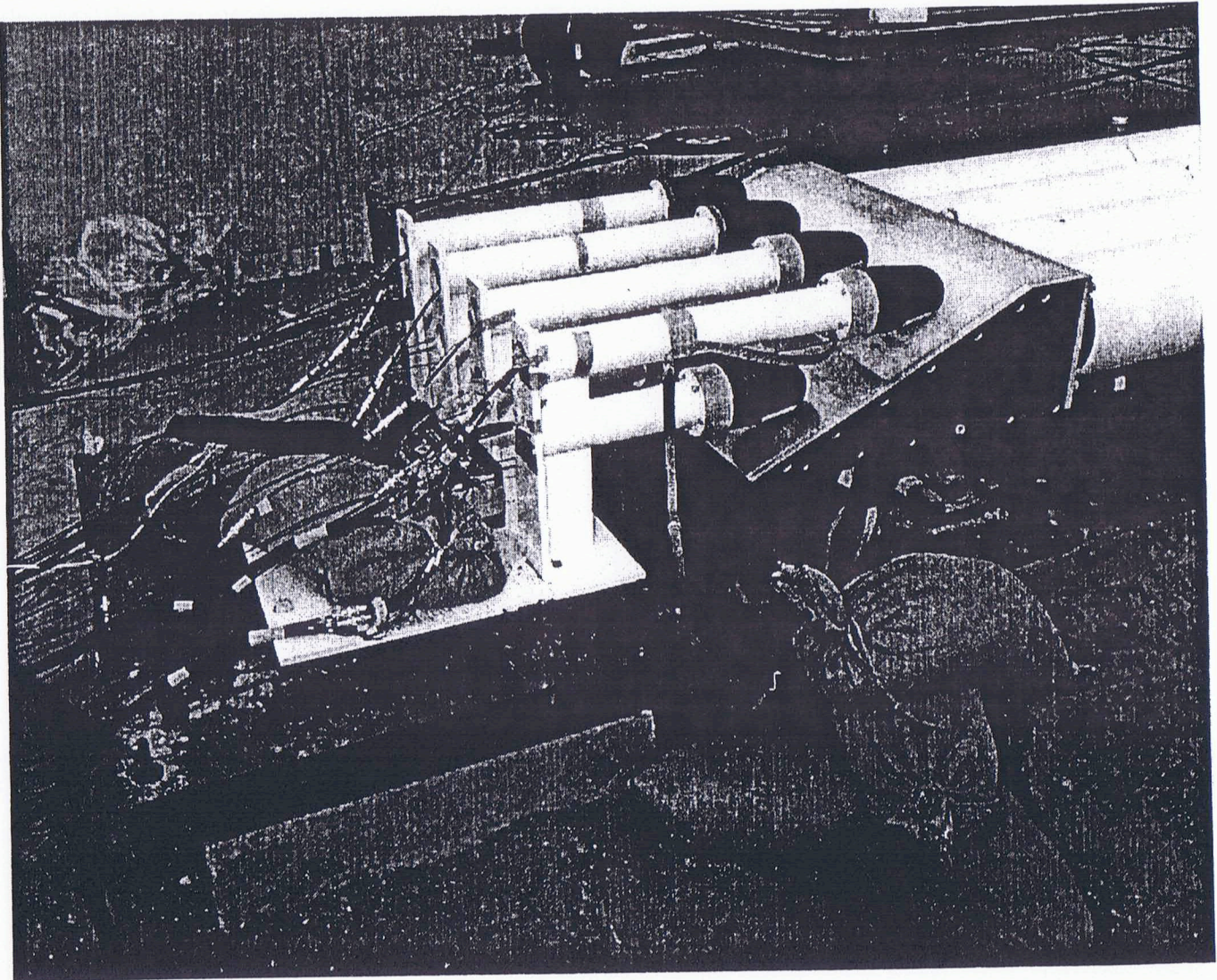

~~SECRET~~ UNCLASSIFIED

~~SECRET~~ UNCLASSIFIED

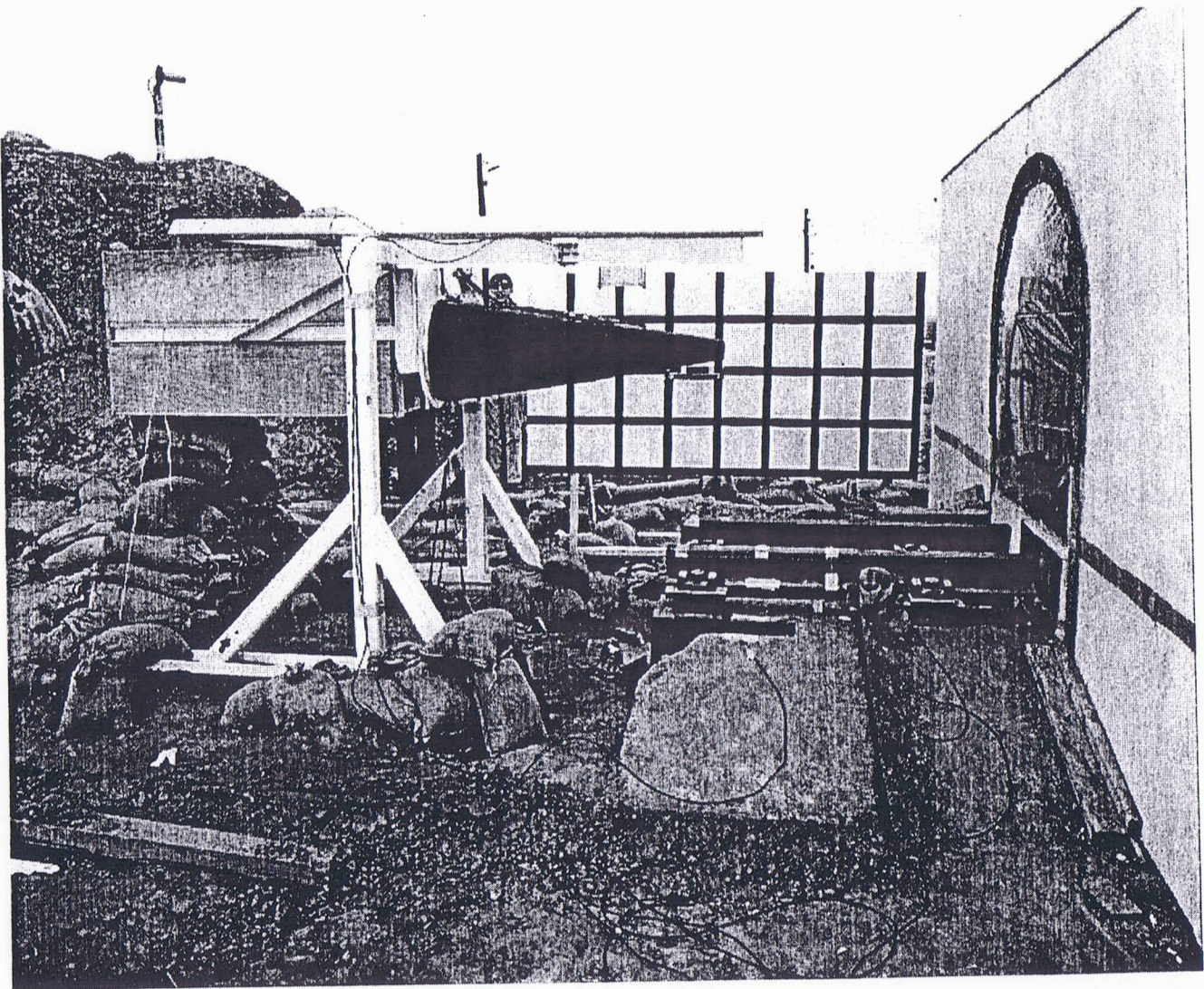

**ALPHA** UNCLASSIFIED

UNCLASSIFIED

**ALPHA**

~~SECRET~~ UNCLASSIFIED

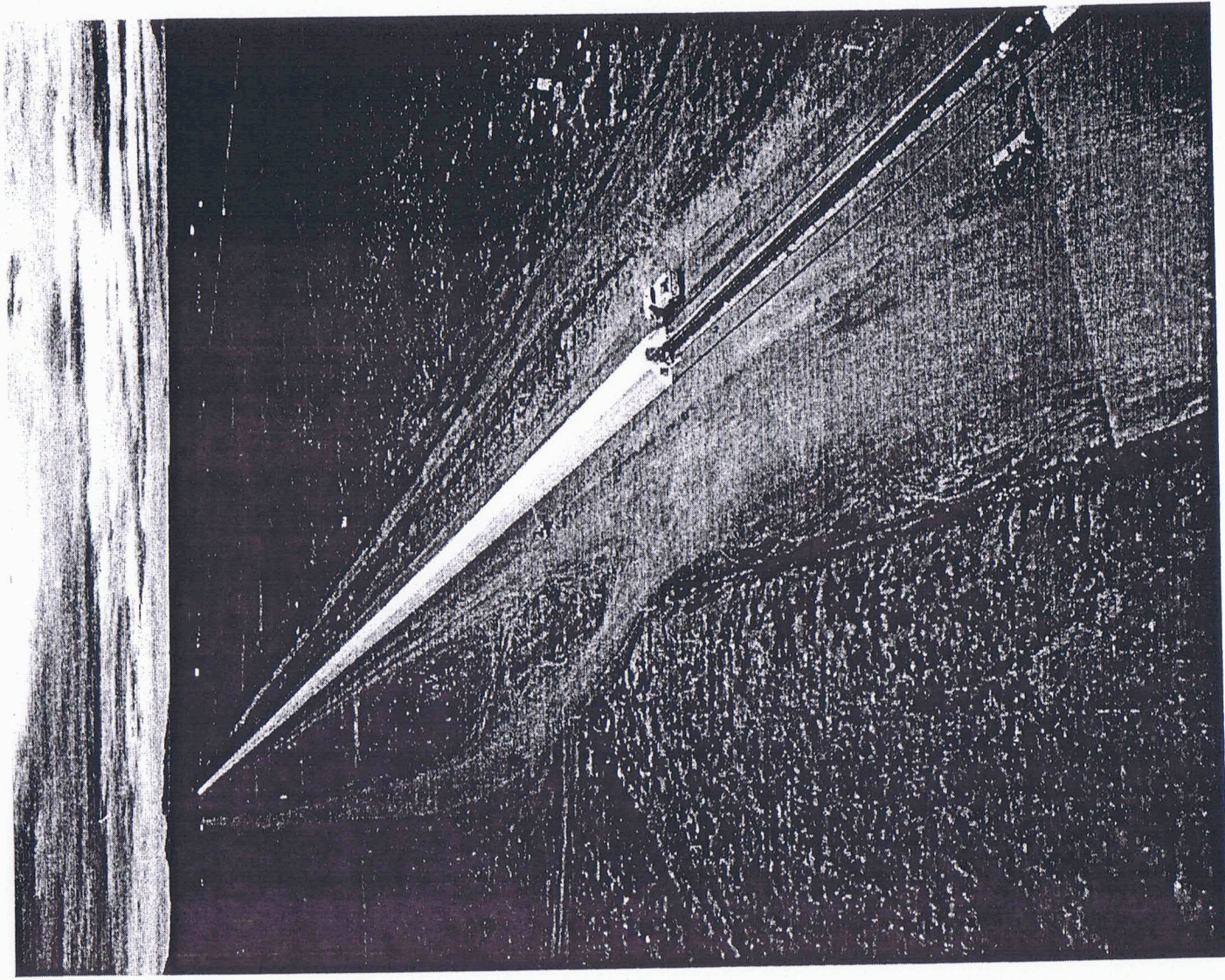

UNCLASSIFIED

~~SECRET~~

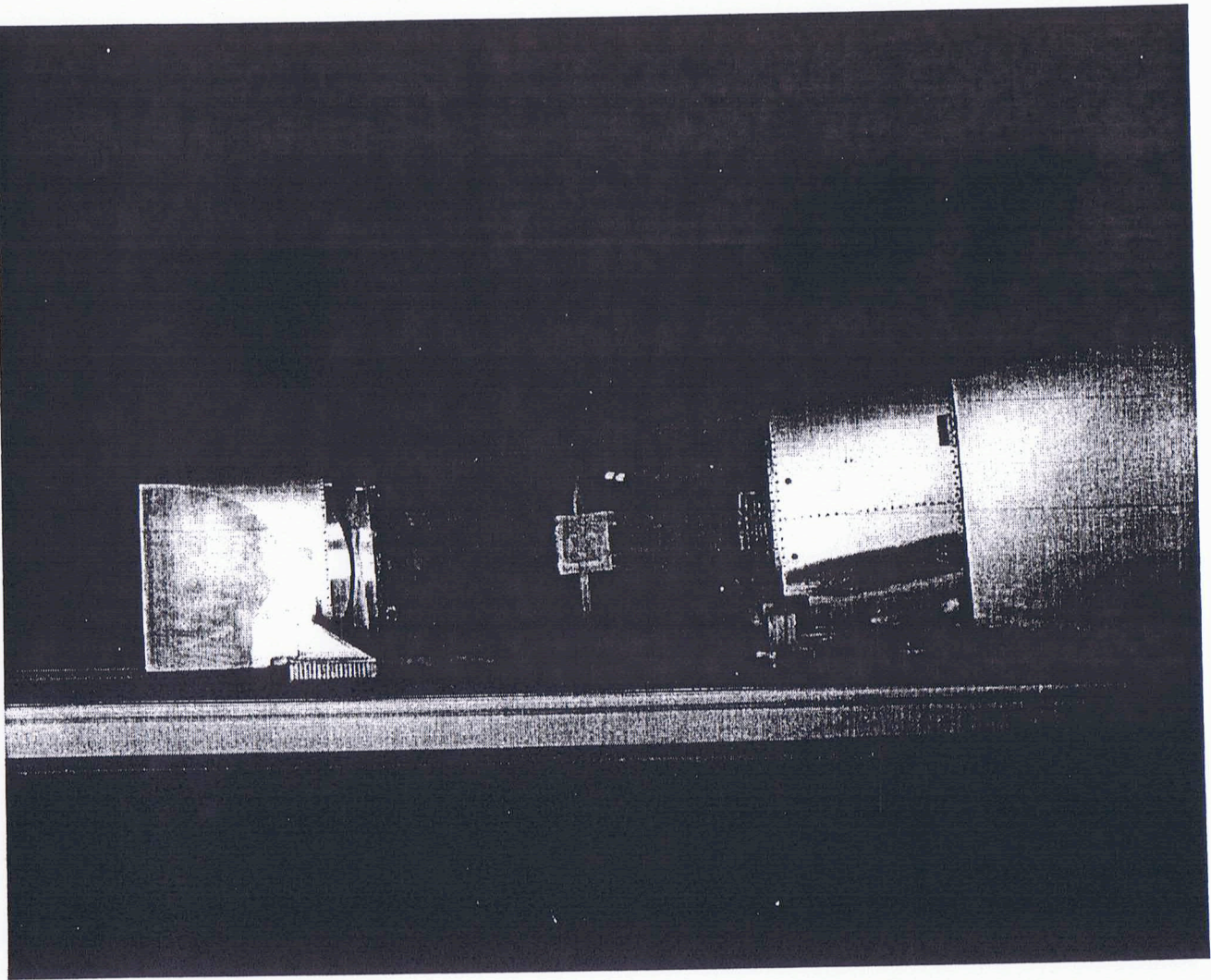

~~SECRET~~ UNCLASSIFIED

UNCLASSIFIED

~~SECRET~~

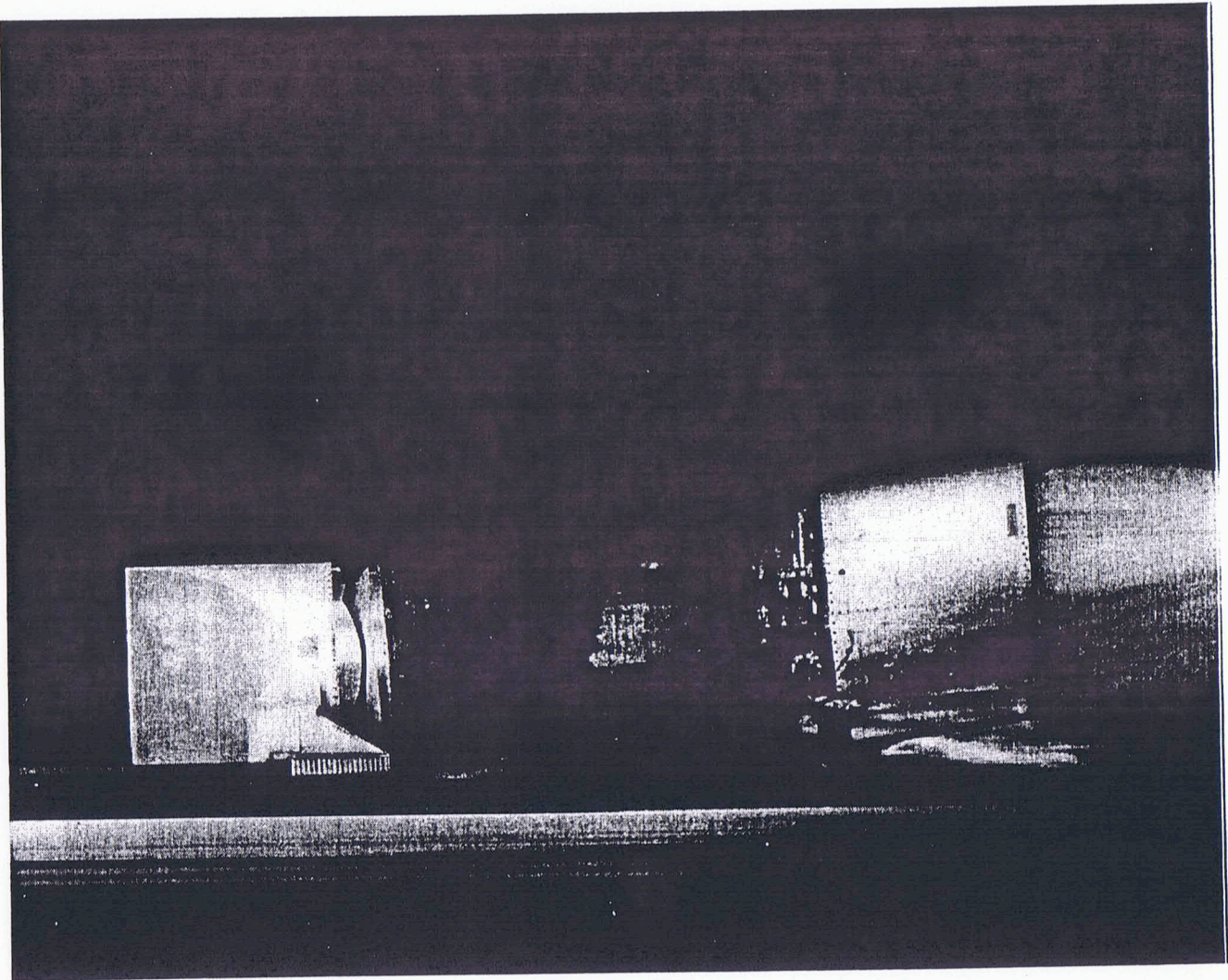

~~SECRET~~  
UNCLASSIFIED

~~SECRET~~  
UNCLASSIFIED



~~SECRET~~ UNCLASSIFIED

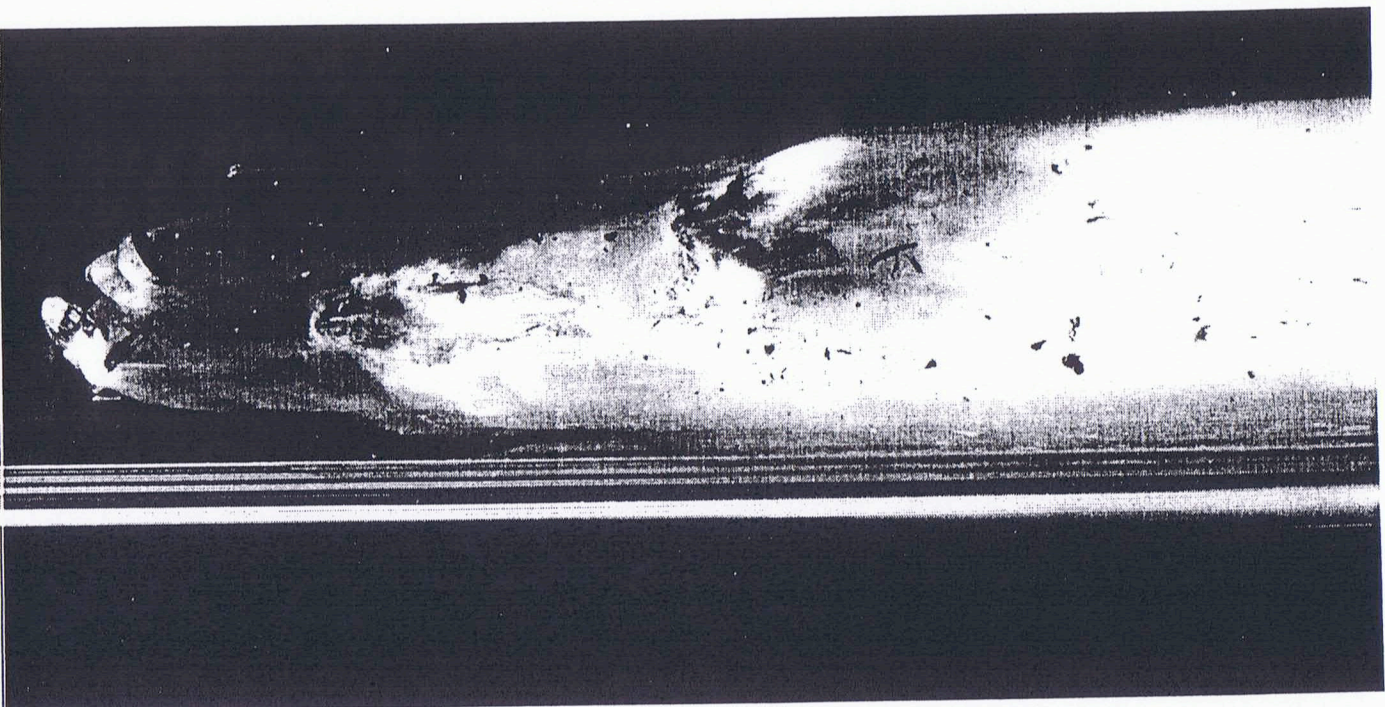

UNCLASSIFIED

~~SECRET~~

~~UNCLASSIFIED~~ UNCLASSIFIED

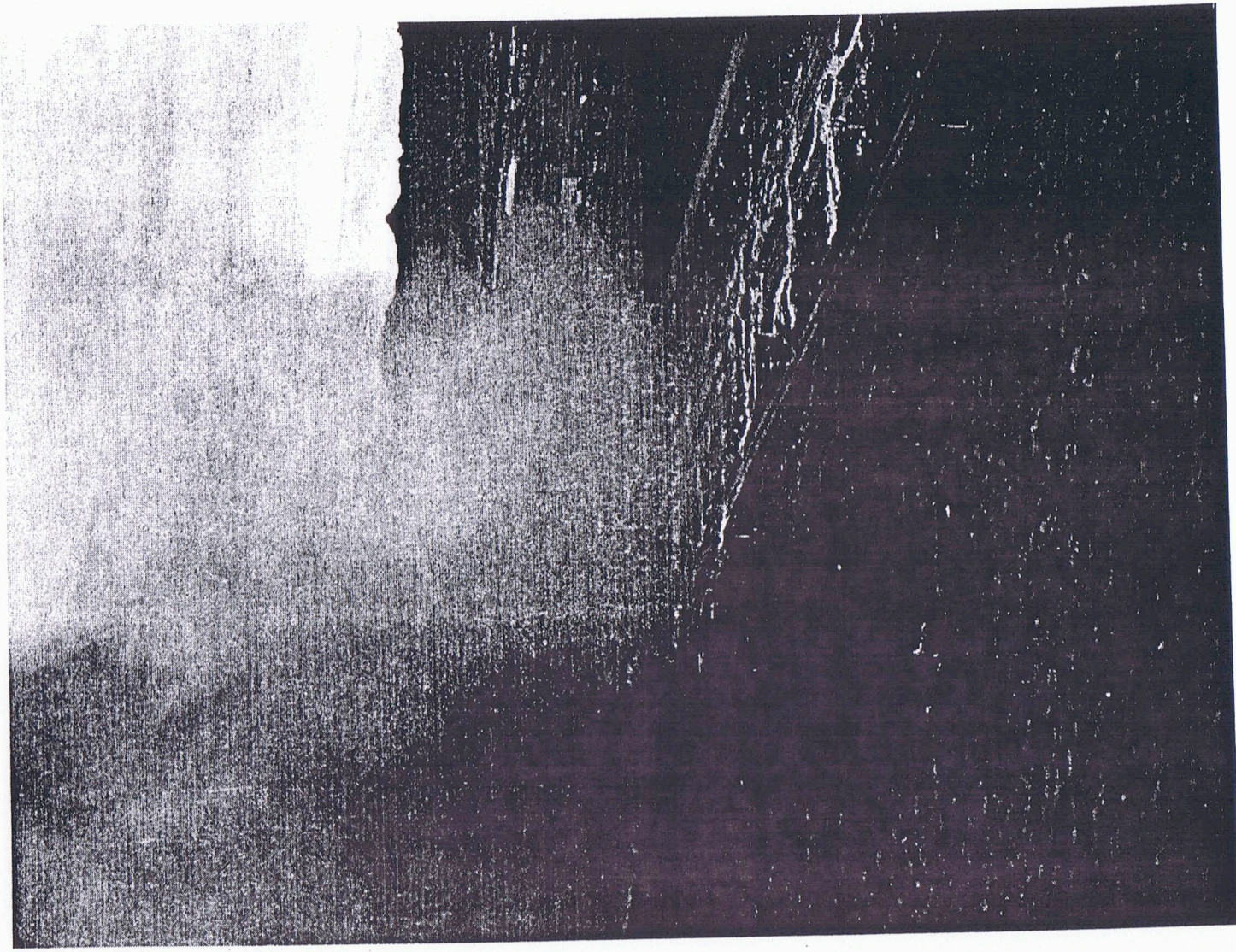

UNCLASSIFIED  
~~UNCLASSIFIED~~

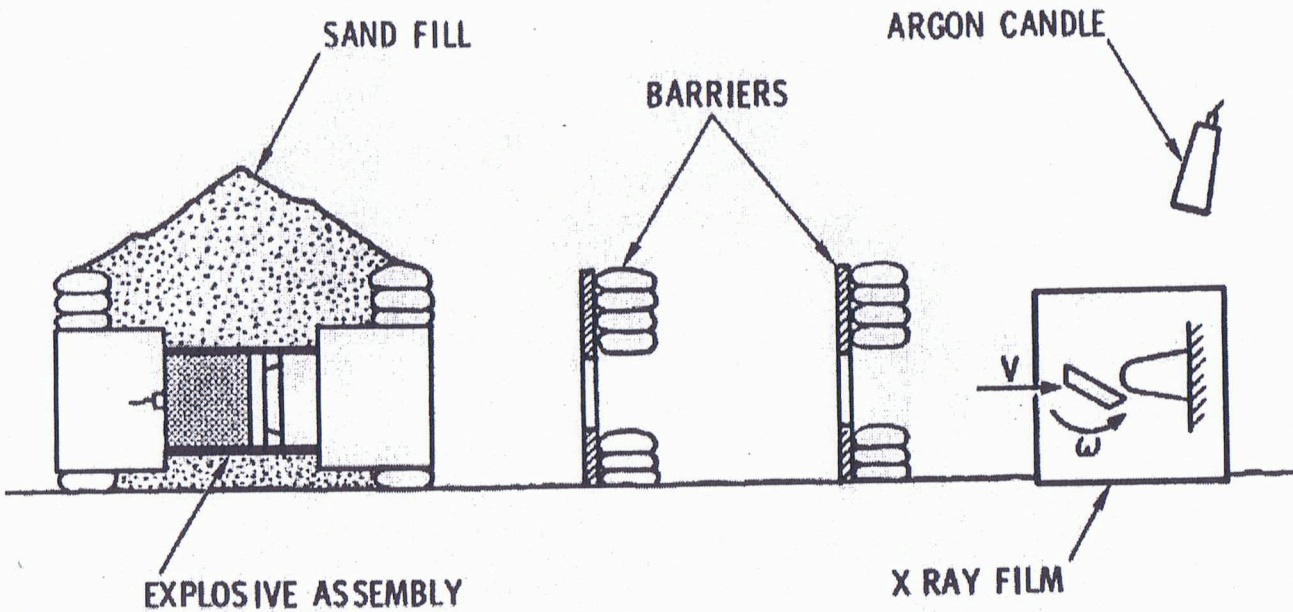

SECRET

UNCLASSIFIED

SECRET  
UNCLASSIFIED

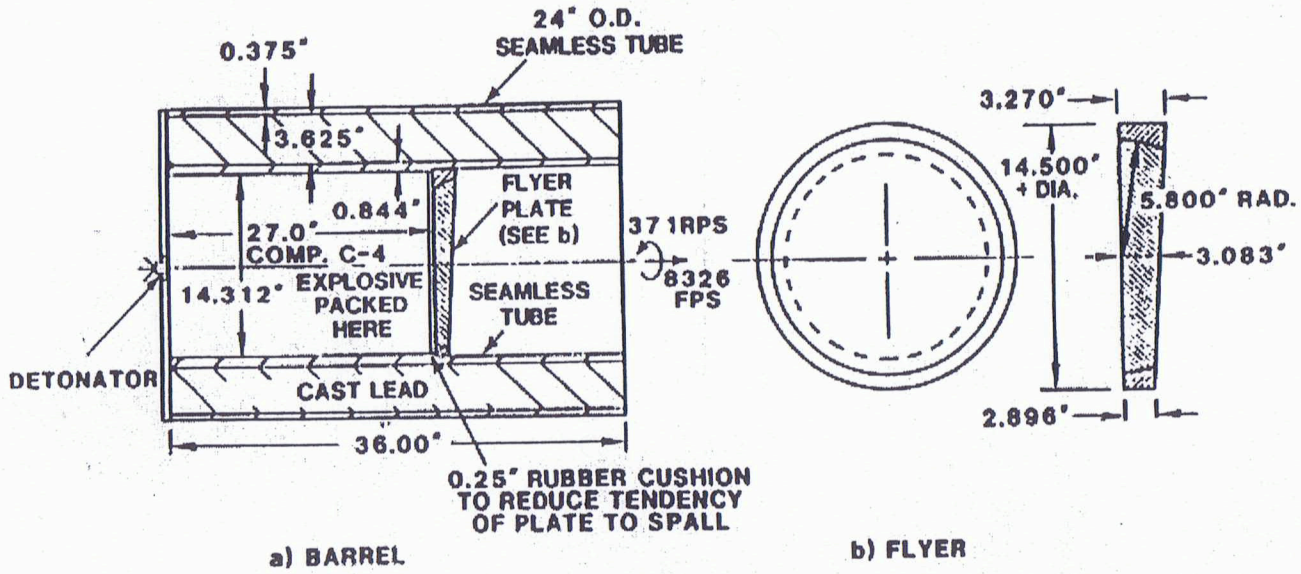

SECRET

UNCLASSIFIED

SECRET

UNCLASSIFIED

~~SECRET~~ UNCLASSIFIED

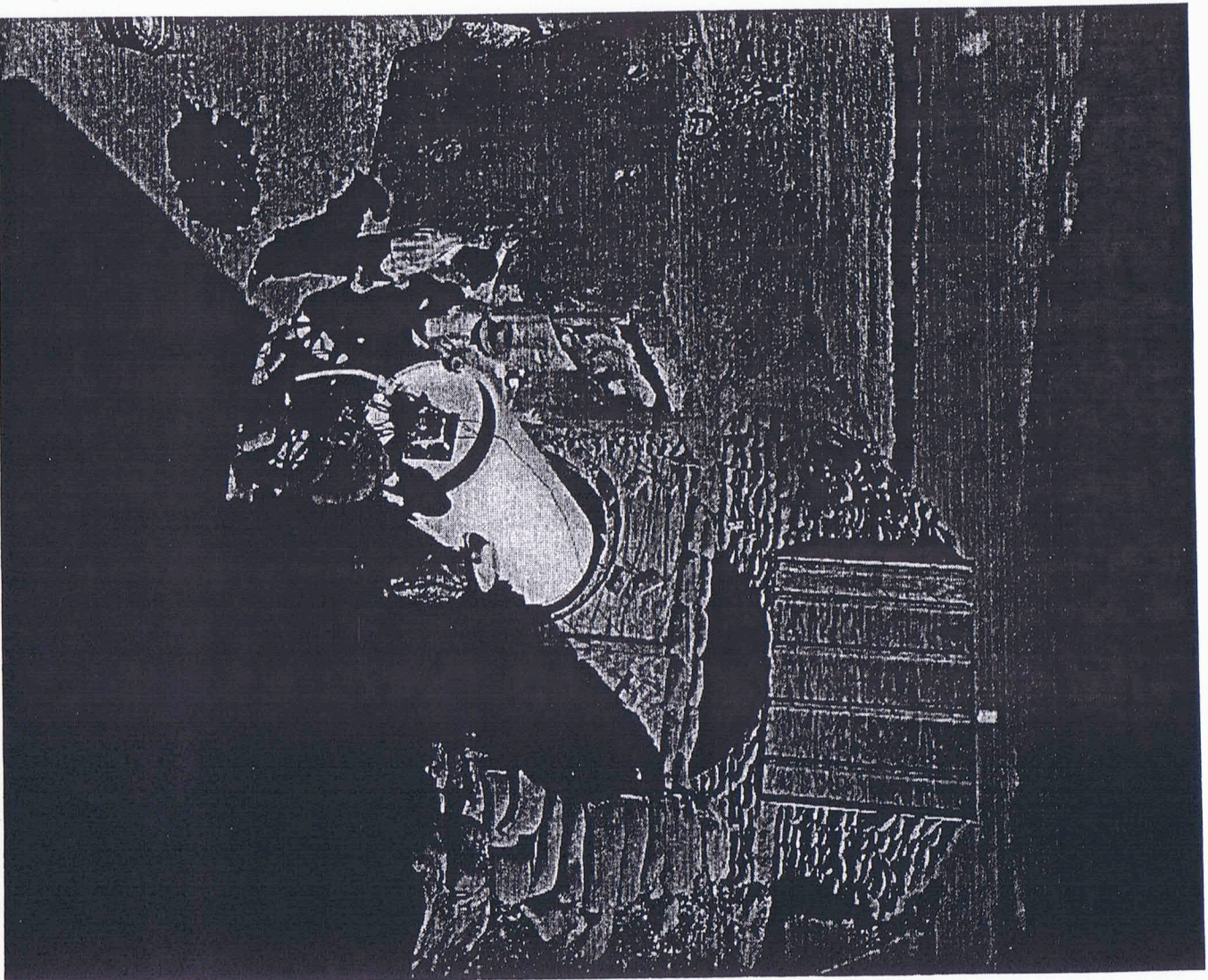

UNCLASSIFIED

~~SECRET~~

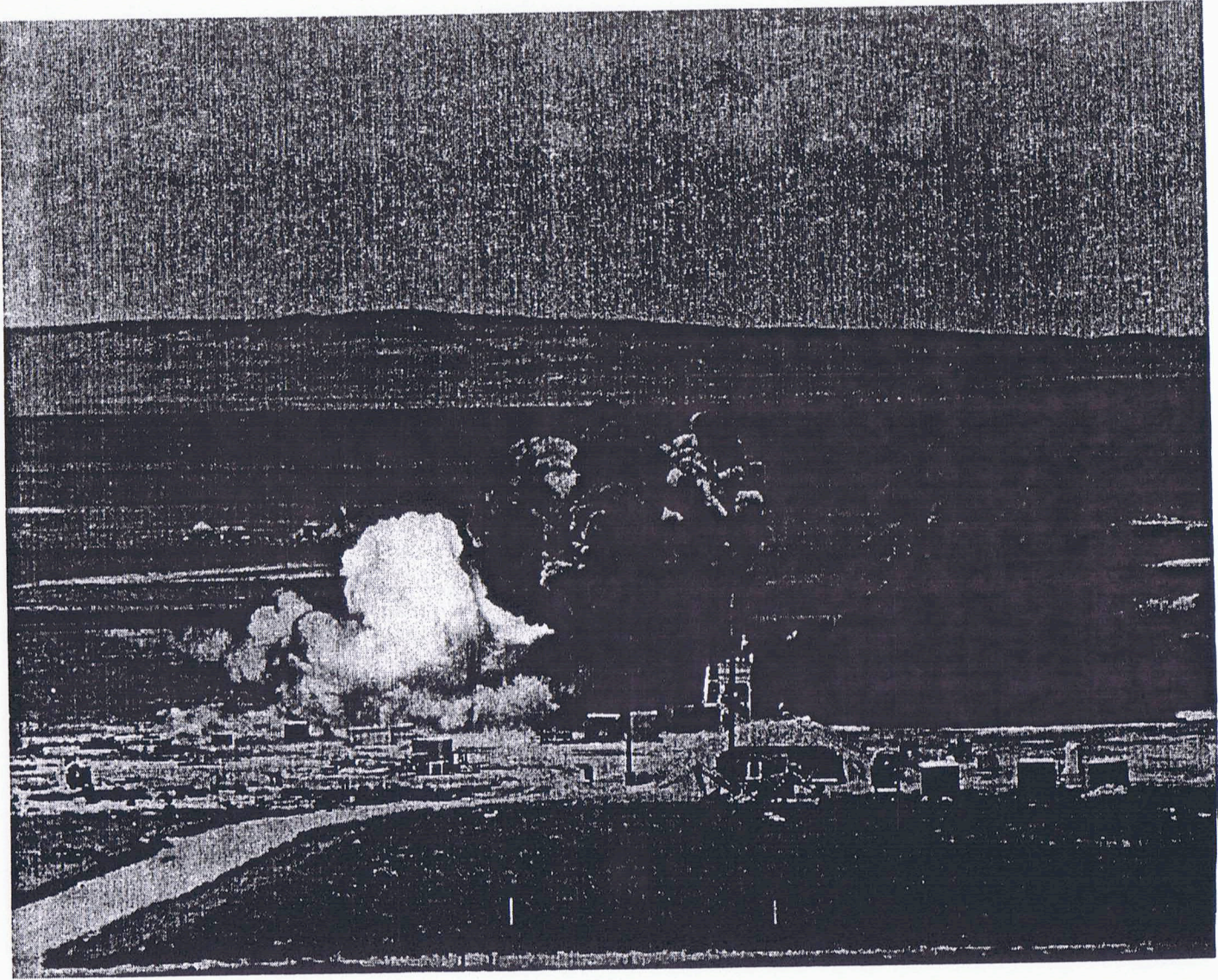

SECRET

UNCLASSIFIED

SECRET  
UNCLASSIFIED

~~SECRET~~  
UNCLASSIFIED



b(3)

UNCLASSIFIED

~~SECRET~~

b(3)

~~SECRET~~ UNCLASSIFIED

UNCLASSIFIED

~~SECRET~~



~~SECRET~~

UNCLASSIFIED

b (3)

UNCLASSIFIED

~~SECRET~~

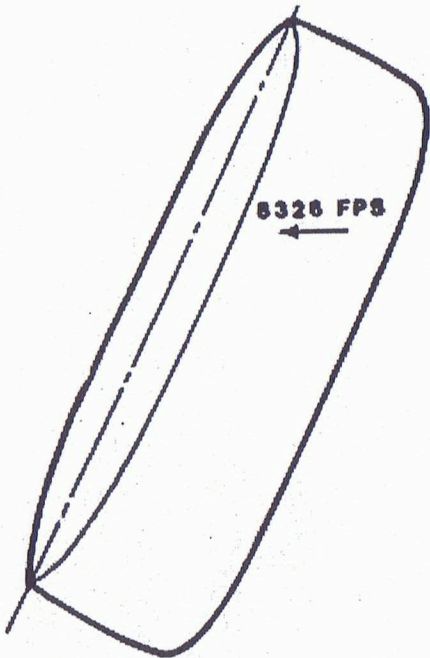
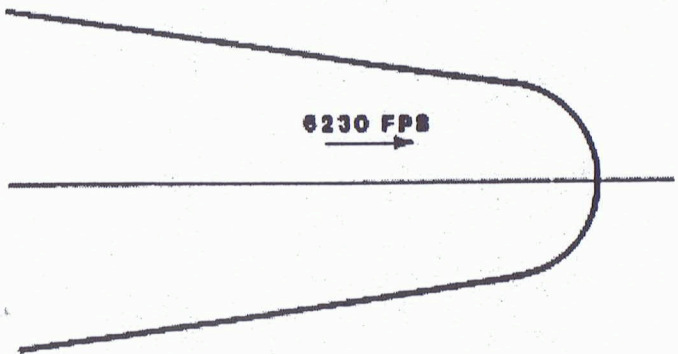

~~SECRET~~

UNCLASSIFIED

~~SECRET~~  
UNCLASSIFIED

SECRET

UNCLASSIFIED

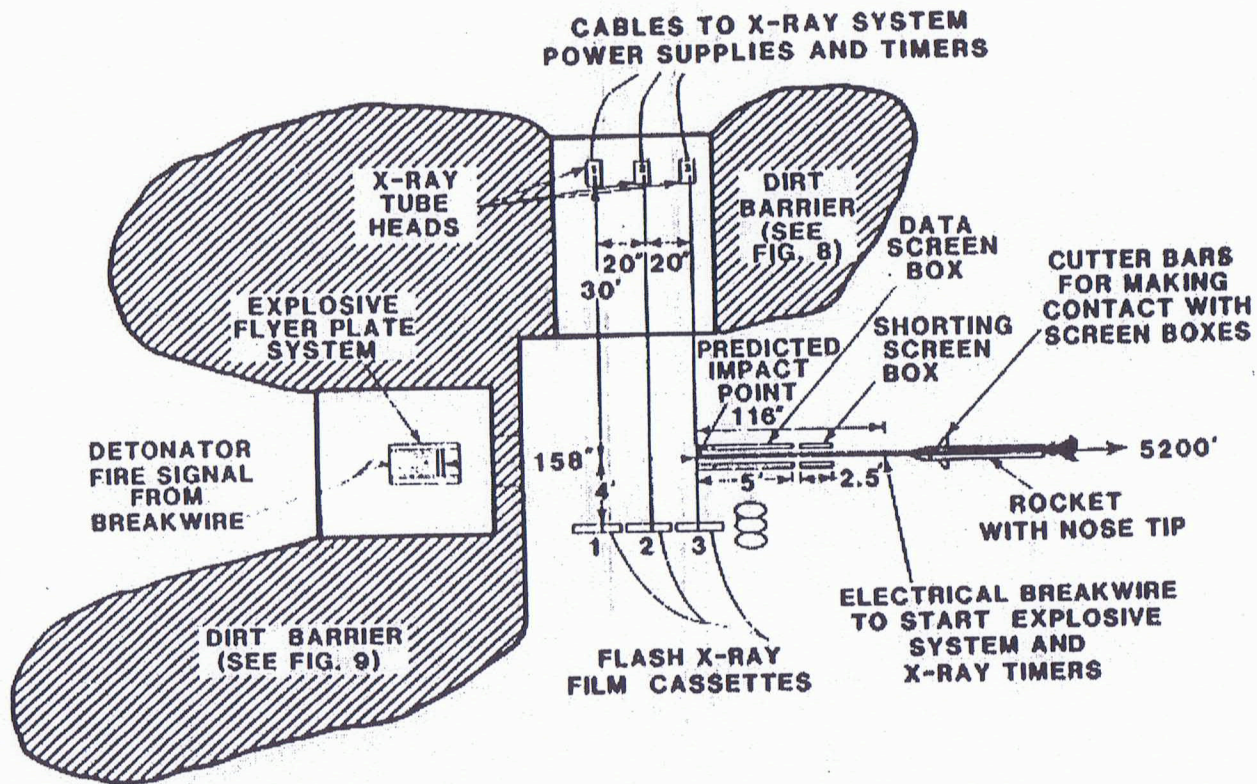

SECRET UNCLASSIFIED

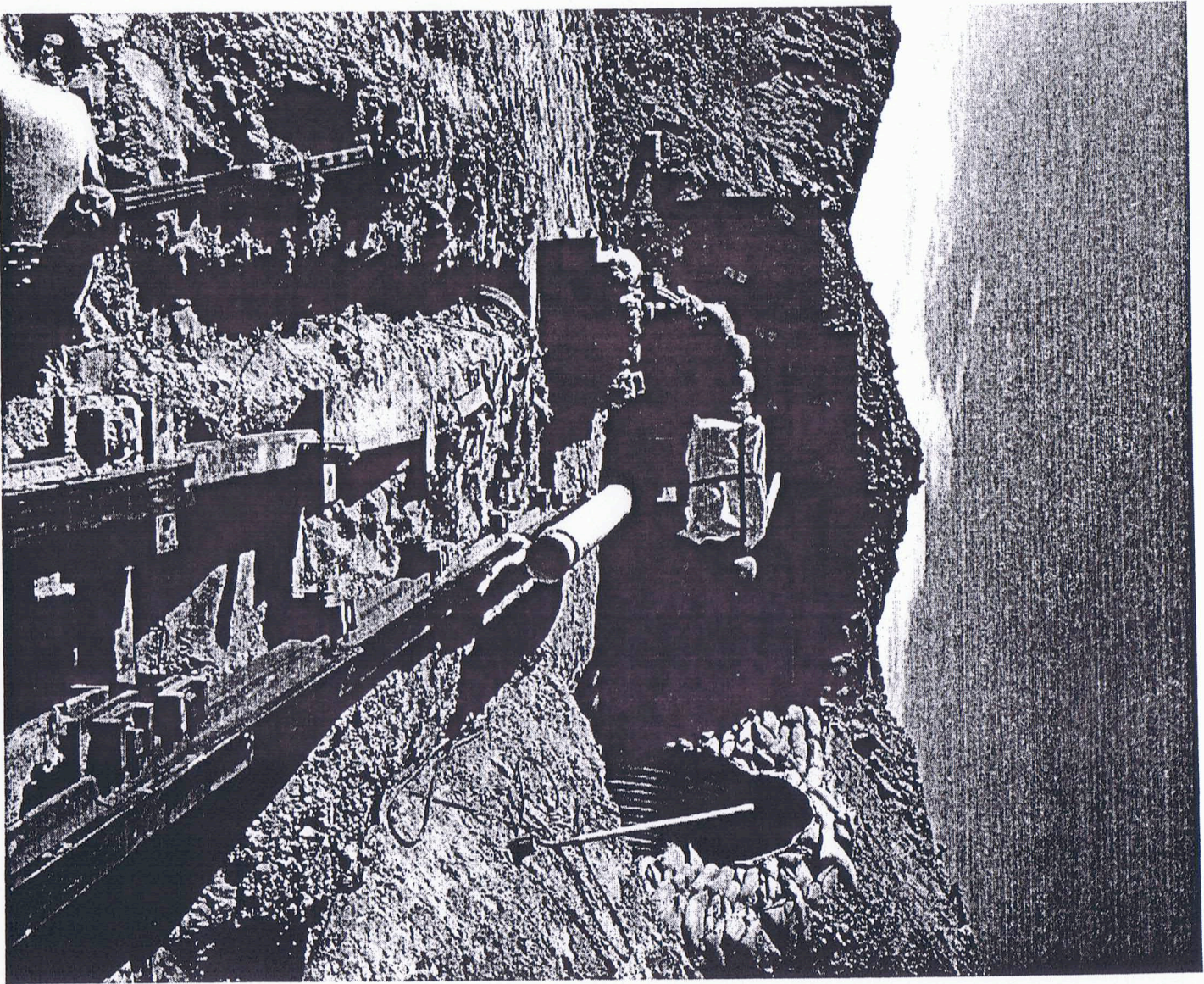

*SECRET*  
UNCLASSIFIED

*SECRET*  
UNCLASSIFIED

~~SECRET~~ UNCLASSIFIED

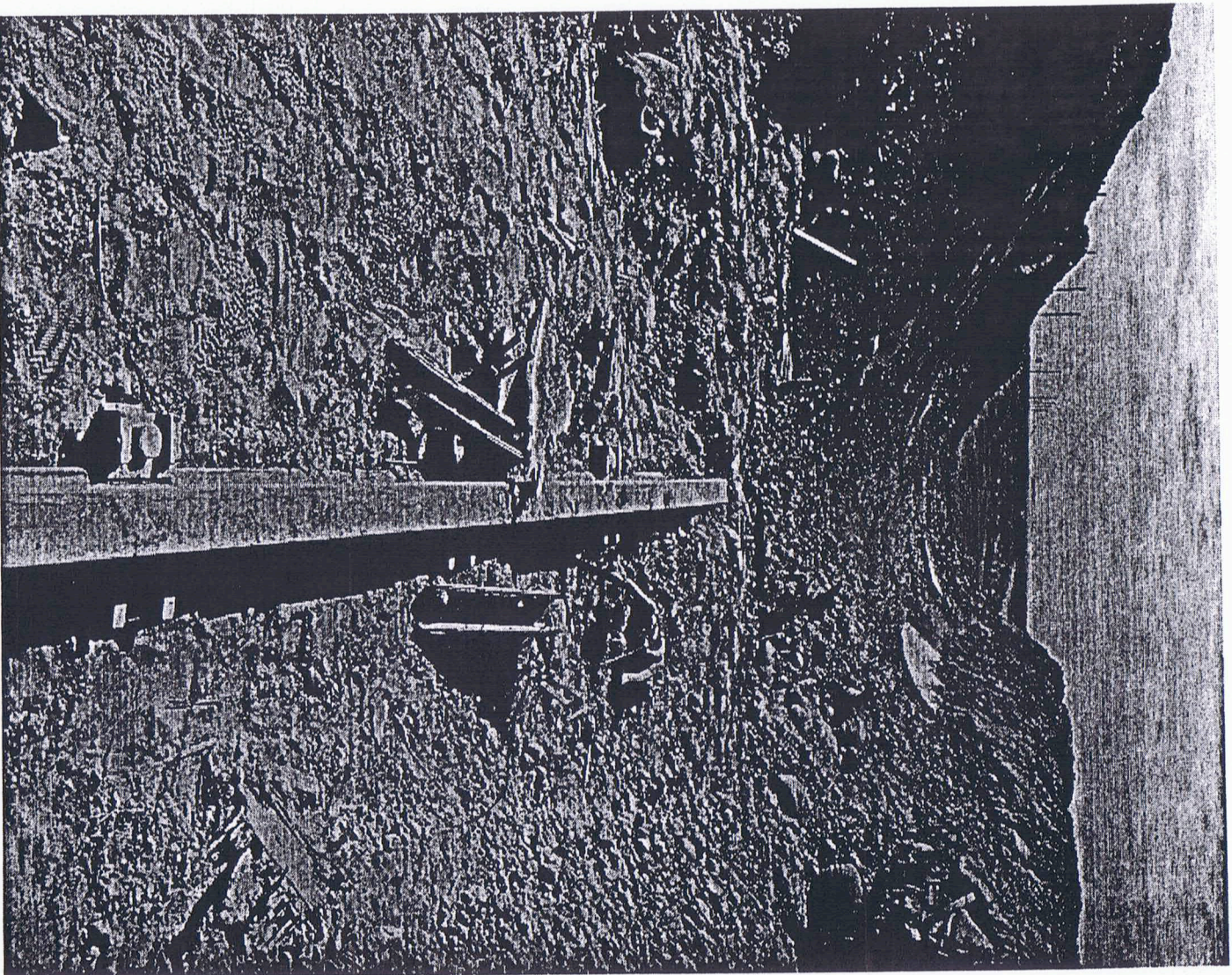

UNCLASSIFIED

~~SECRET~~

DOE  
b(3)

~~SECRET~~ UNCLASSIFIED

UNCLASSIFIED

~~SECRET~~

100  
100

~~SECRET~~

b(3)

UNCLASSIFIED

UNCLASSIFIED

~~SECRET~~

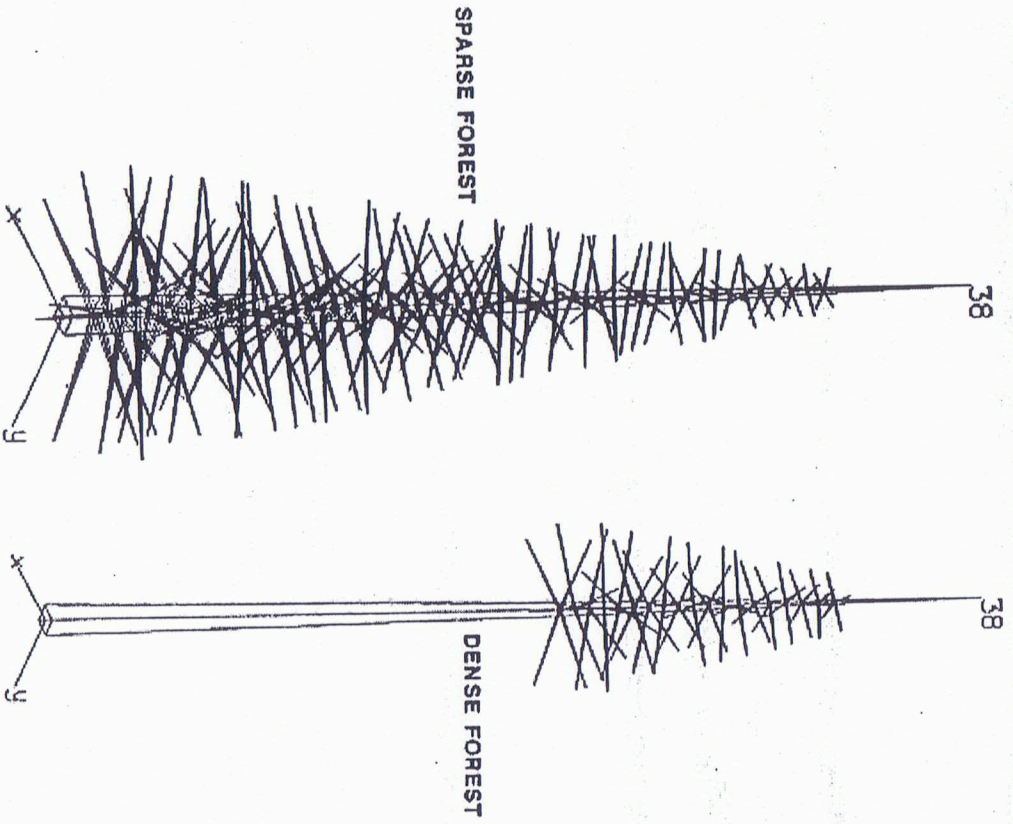

Pine Tree Models for Sparse and Dense Forests



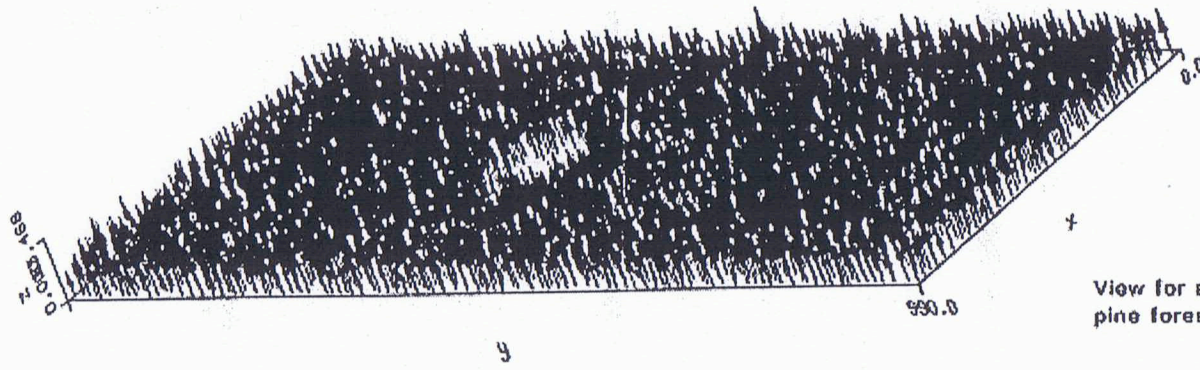

View for a 100 year old  
pine forest, P=0.80

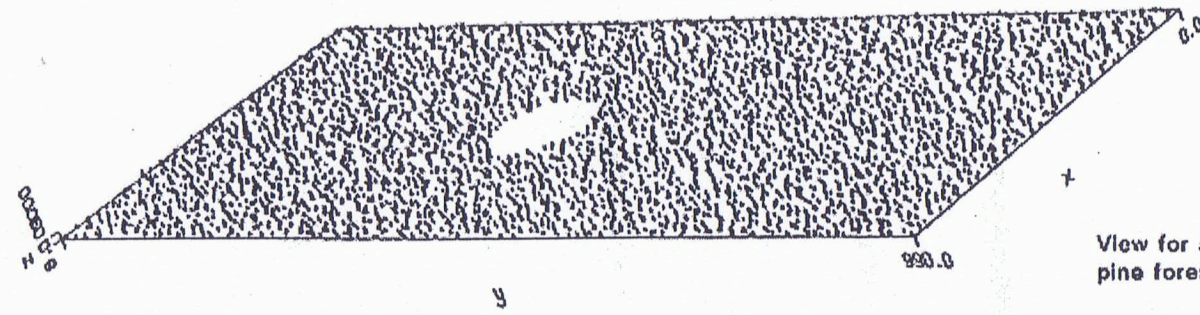

View for a 7 year old  
pine forest, P=0.13

SECRET

UNCLASSIFIED

SECRET

UNCLASSIFIED

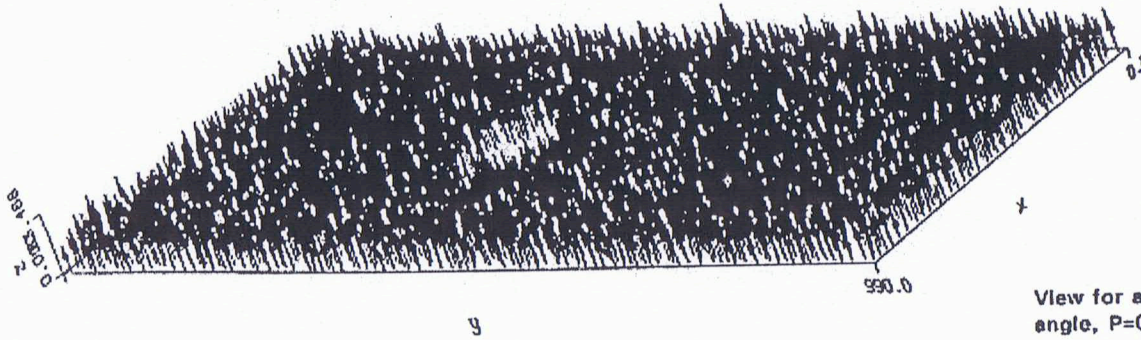

View for a 20° impact angle, P=0.80

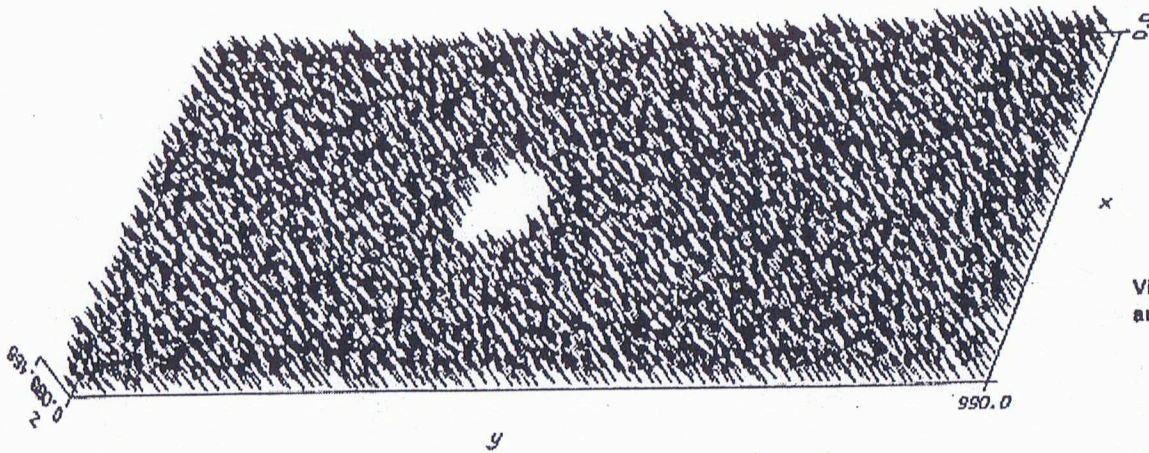

View for a 40° impact angle, P=0.54

~~SECRET~~  
UNCLASSIFIED

~~SECRET~~  
UNCLASSIFIED

~~SECRET~~ UNCLASSIFIED

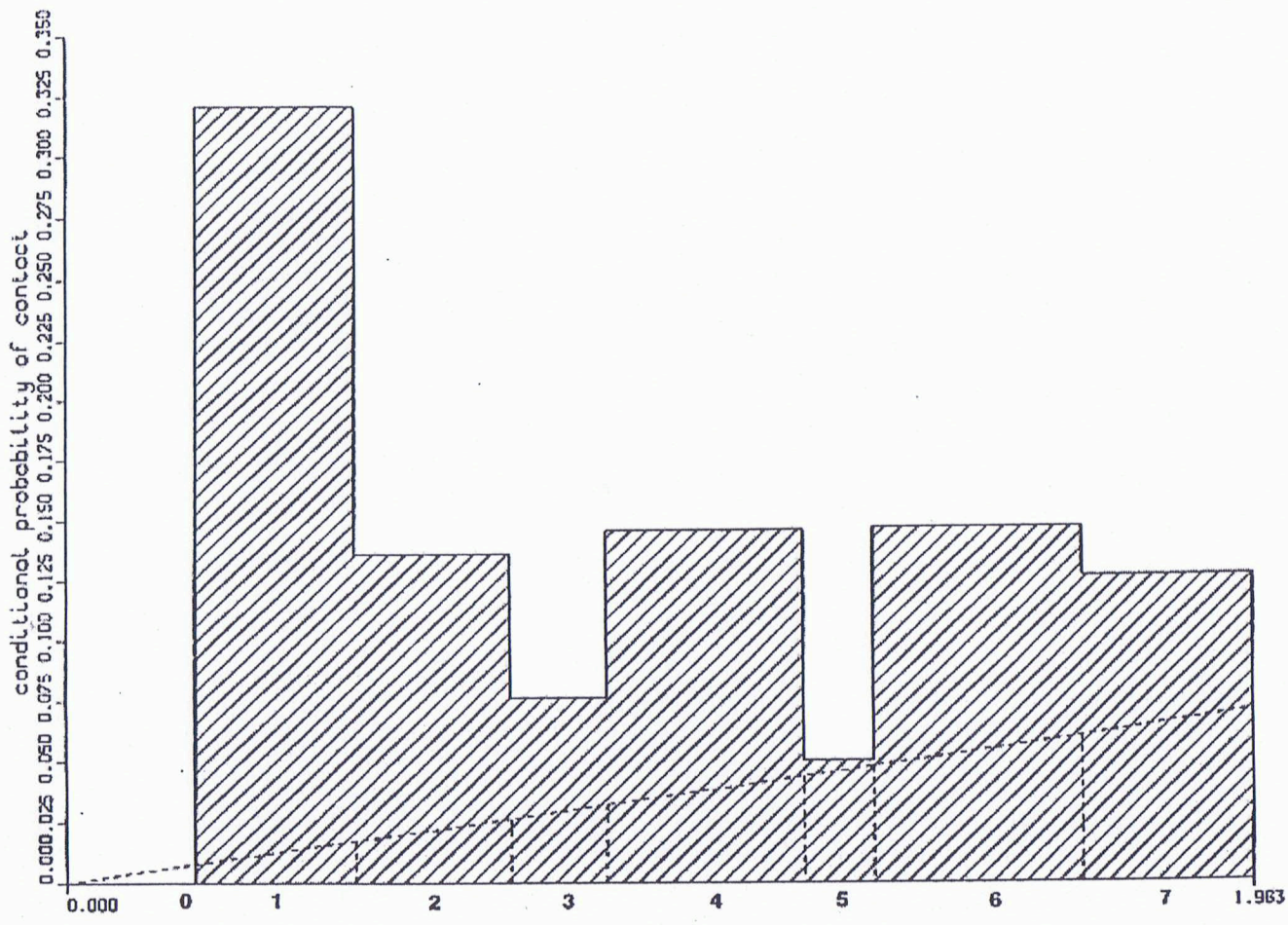

Conditional Probabilities of Tree Impacts on the Reentry Vehicle Surface

~~SECRET~~ UNCLASSIFIED

## Improved surface fuzing concepts have been explored for every new reentry system

---

- Faster-responding impact sensors
  - concepts include:
    - faster-sensing mechanisms
    - forward deployment of traditional sensors
  - little, if any, additional protection against impact irregularities
- Radar proximity fuzing
  - adequate survivability for all impact scenarios
  - little, if any, degradation in burst height effectiveness

SECRET

UNCLASSIFIED

SECRET

UNCLASSIFIED

DA  
7

~~SECRET~~ UNCLASSIFIED

b(3)

UNCLASSIFIED

~~SECRET~~

100  
100

~~SECRET~~  
UNCLASSIFIED

UNCLASSIFIED

~~SECRET~~

~~SECRET~~  
UNCLASSIFIED

DOE  
b(3)

UNCLASSIFIED

~~SECRET~~

DOE  
b(5)

~~SECRET~~  
UNCLASSIFIED

UNCLASSIFIED

~~SECRET~~



~~ADDERA~~

~~UNCLASSIFIED~~

(3)

UNCLASSIFIED

~~ADDERA~~

## Inertial Devices

---

- **Mechanical** g-switches & integrating accelerometers
  - Stand-alone inertial fuze or initiation of reentry timer fuze
  - Closure of electrical contacts cause by completion of sensing mass travel
  - Features to attain minimum g's and g-seconds
    - Fluid-metering
    - Escapement mechanism
  - Mechanical feature variations limit accuracy to 1%
  - Extensive use as nuclear safety switches
- **Electronic** integrating accelerometers
  - Stand-alone inertial fuze or part of "path length" mechanization
  - Control circuitry generates "restoring current" proportional to acceleration
  - Provides continuous measurement of integrated deceleration
  - Electrical circuit tolerancing controls accuracy to 0.1%

~~SECRET~~  
UNCLASSIFIED

~~SECRET~~  
UNCLASSIFIED

~~SECRET~~  
UNCLASSIFIED

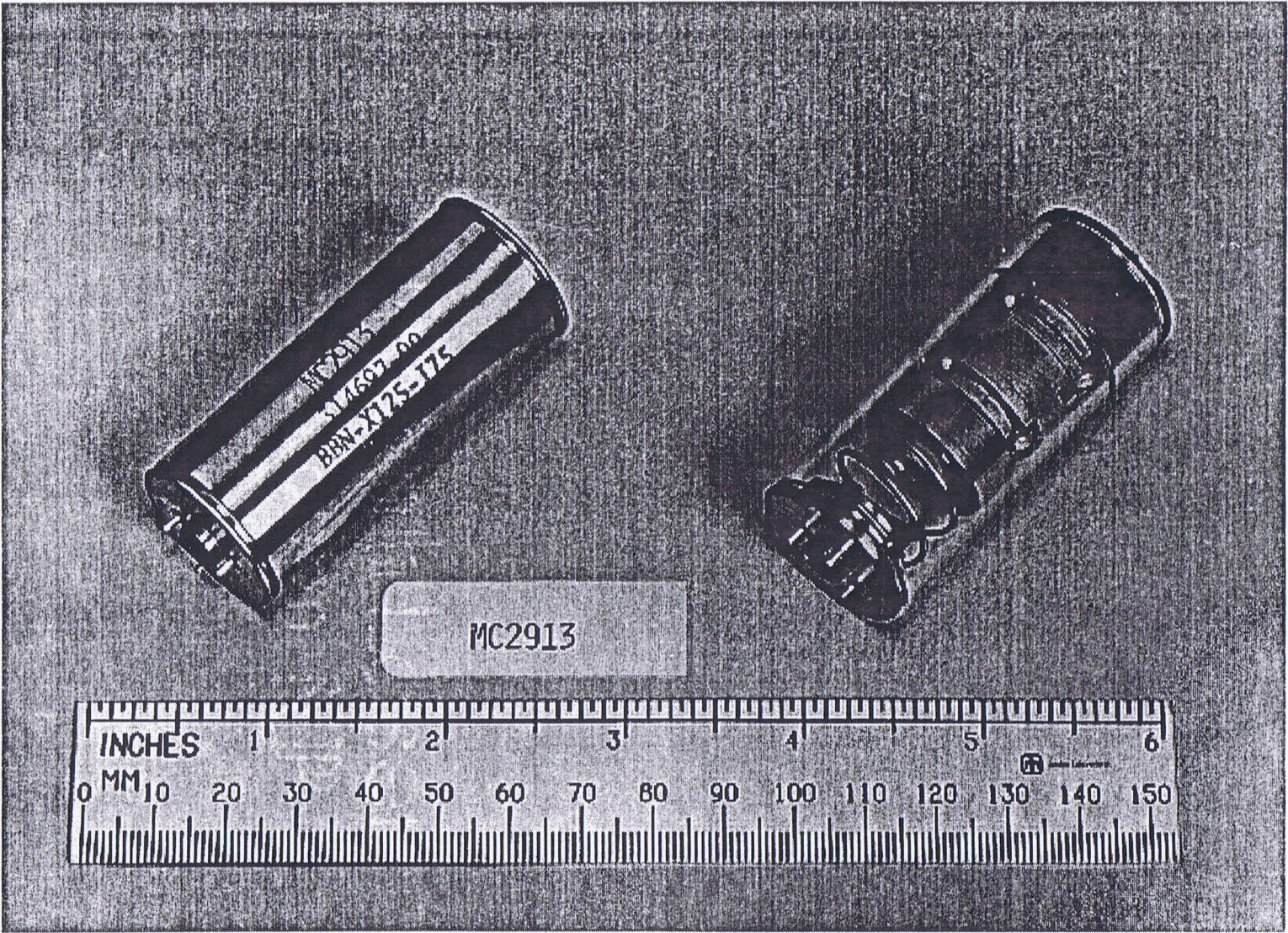

~~SECRET~~  
UNCLASSIFIED

# MC3600 INERTIAL SWITCH

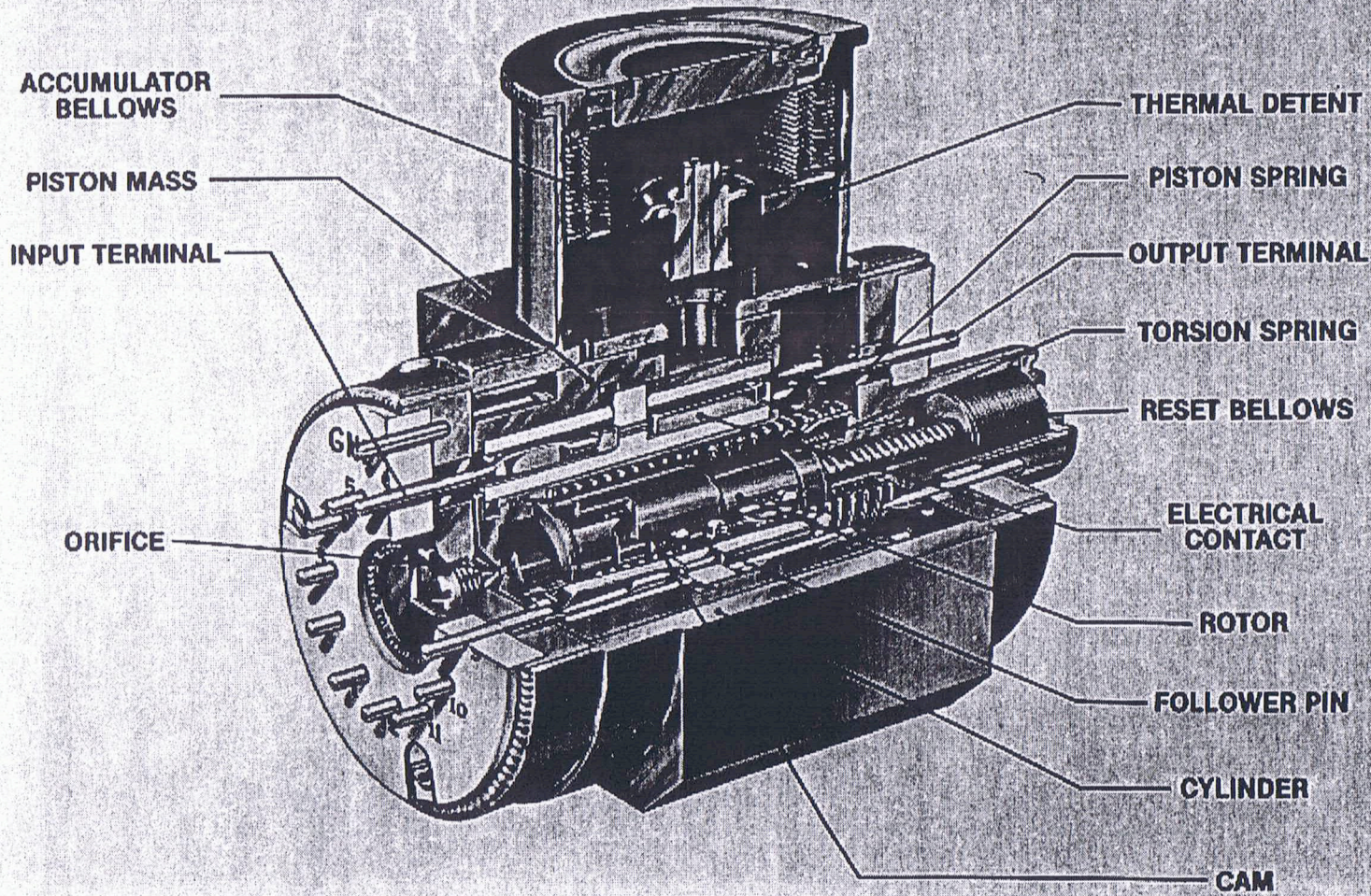

~~SECRET~~  
UNCLASSIFIED

~~SECRET~~  
UNCLASSIFIED

SECRET

UNCLASSIFIED

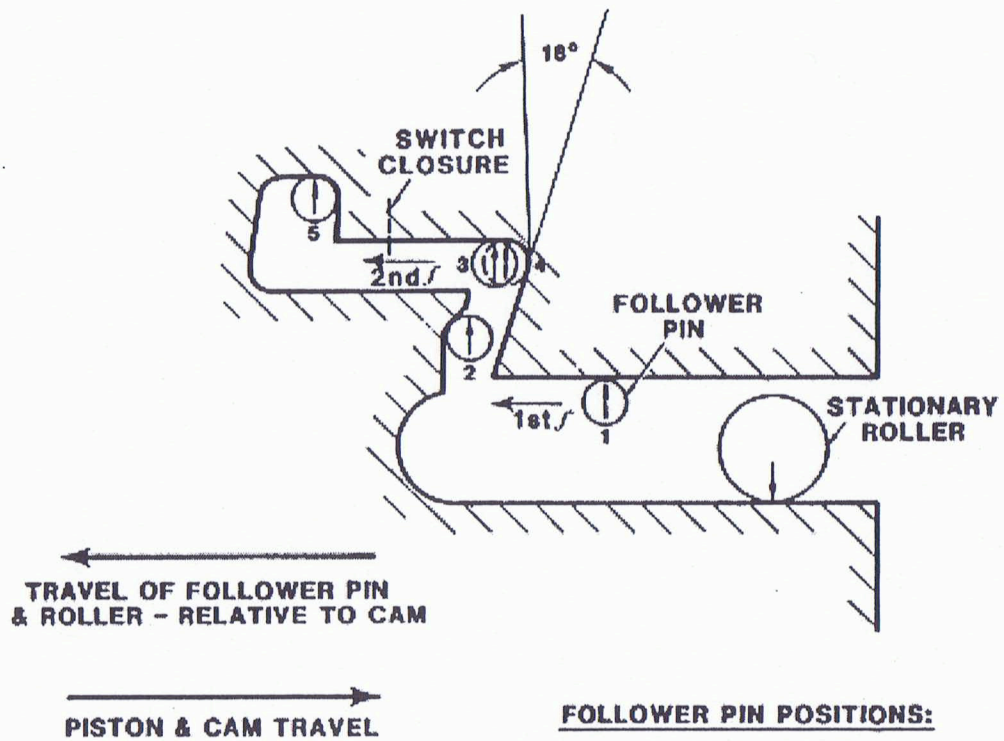

FOLLOWER PIN POSITIONS:

1. RESET
2. 1st STAGE INTEGRATION (PISTON STOP)
3. DROP-THROUGH (PISTON BACKUP)
4. MIDPOINT REST
5. 2nd STAGE INTEGRATION & LATCH

TWO-STAGE CAM SCHEMATIC

SECRET UNCLASSIFIED

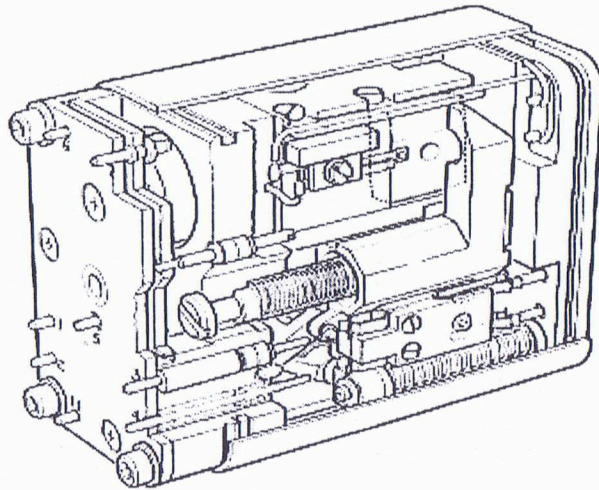

**MC 2897 INERTIAL SWITCH**

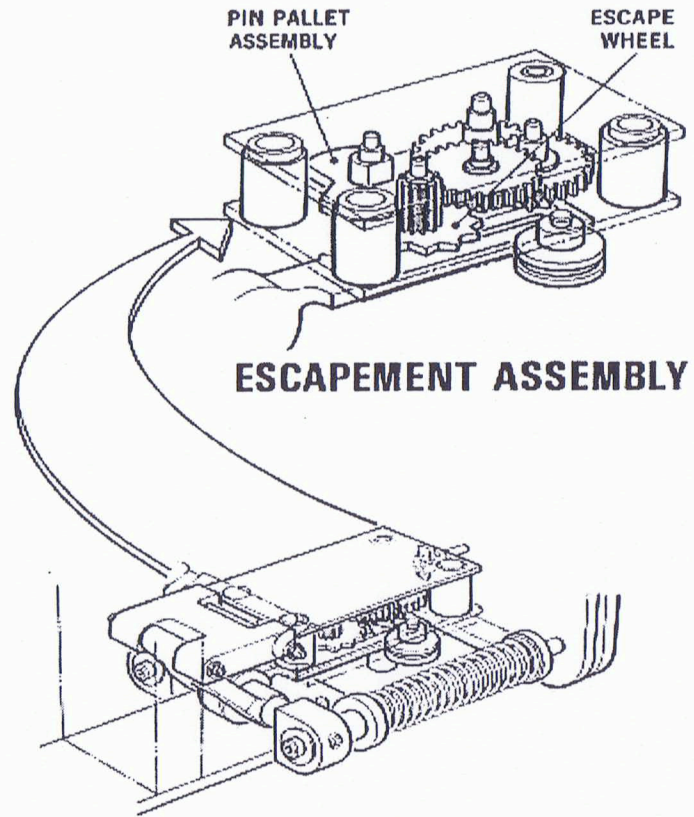

**UNCLASSIFIED**

**UNCLASSIFIED**

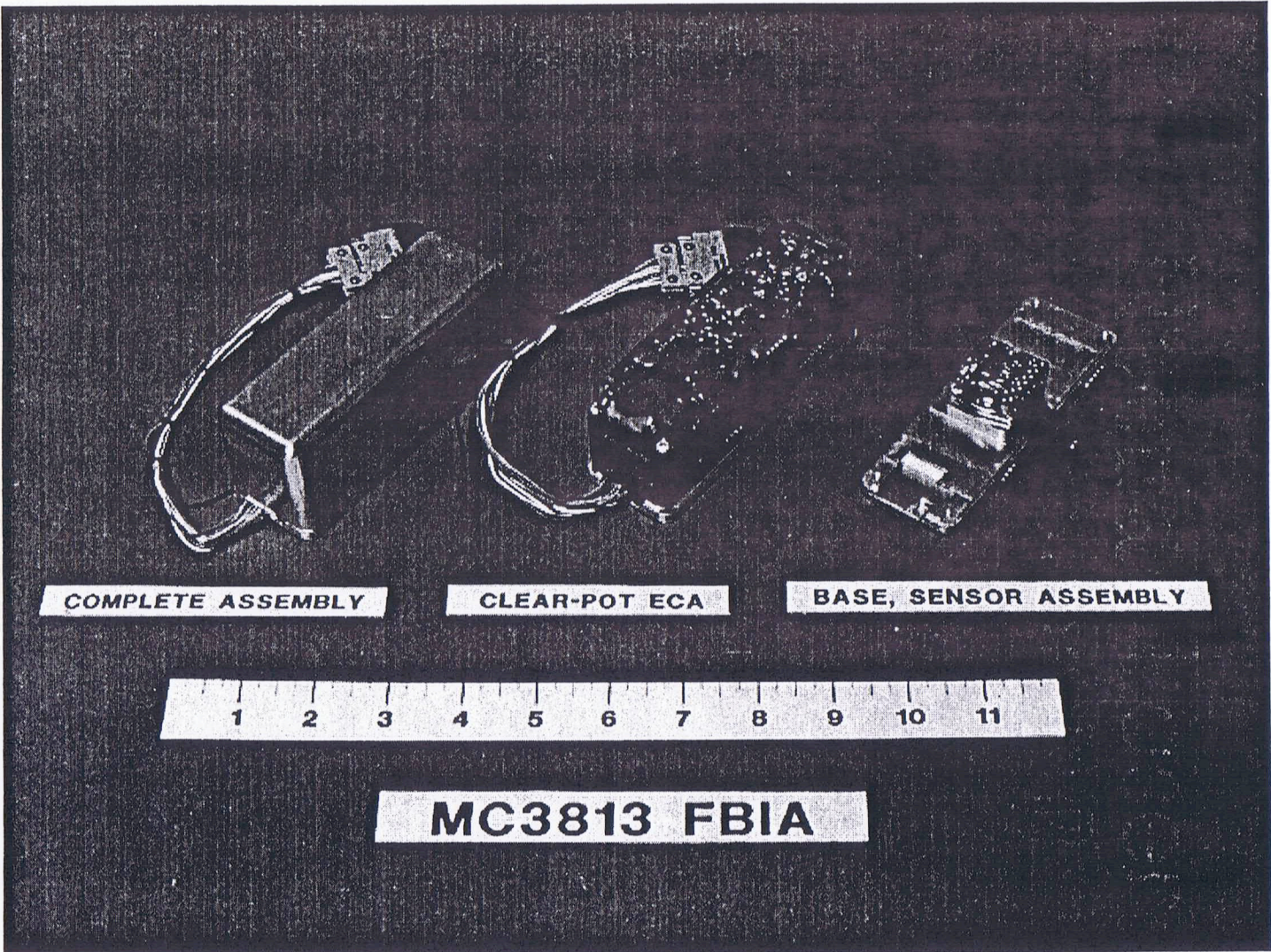

COMPLETE ASSEMBLY

CLEAR-POT ECA

BASE, SENSOR ASSEMBLY

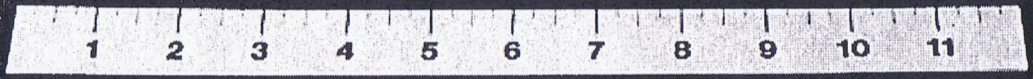

MC3813 FBIA

AT&T

UNCLASSIFIED

UNCLASSIFIED

~~SECRET~~  
UNCLASSIFIED

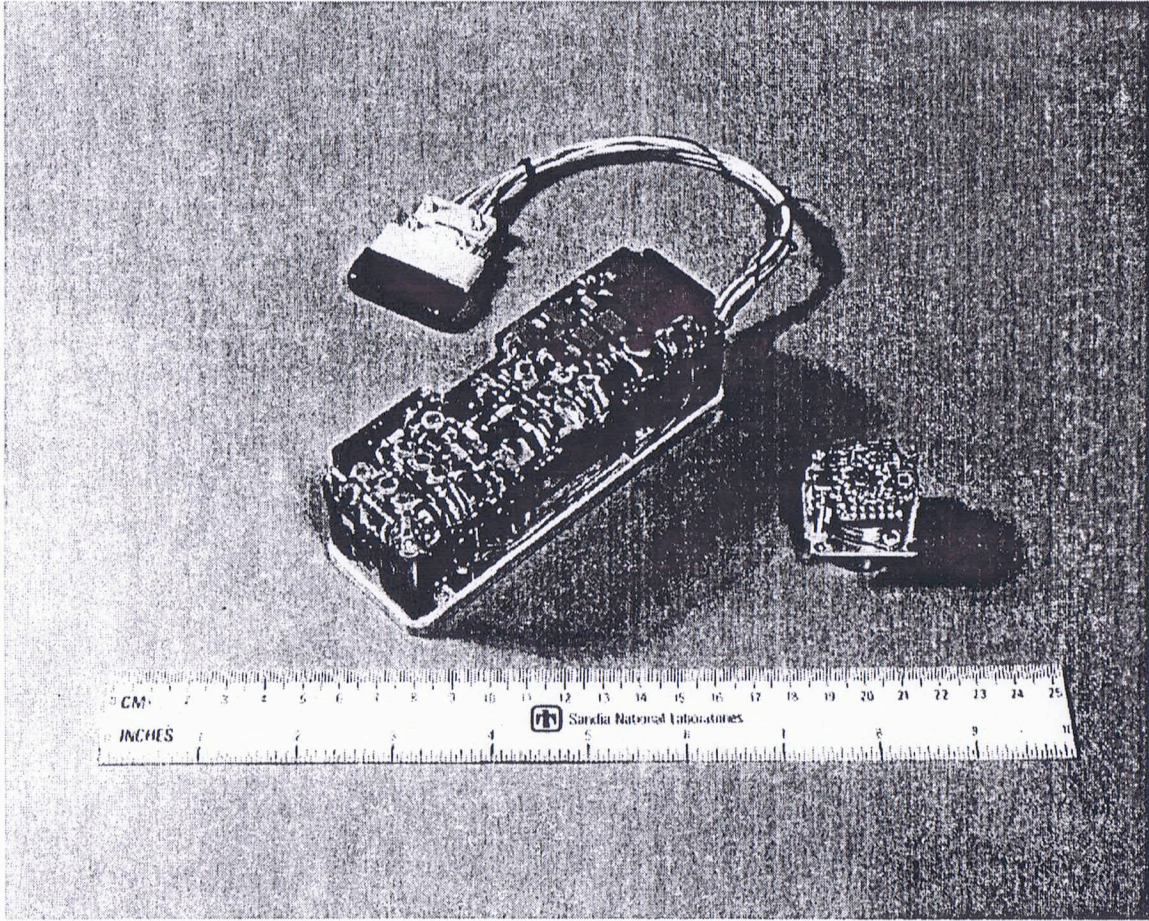

~~SECRET~~  
UNCLASSIFIED



QUARTZ CRYSTAL ACCELERATION SENSOR

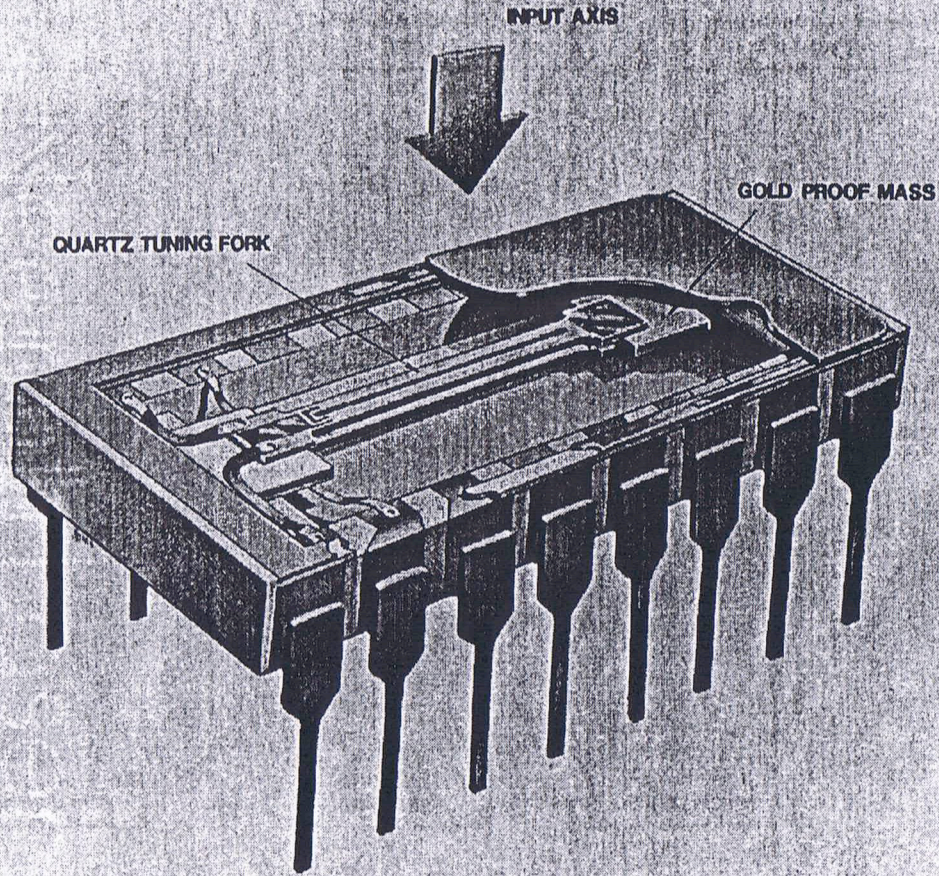

UNCLASSIFIED

UNCLASSIFIED

# Barometric Switches

MC5 1951  
4 element-remote set  
Fuzing

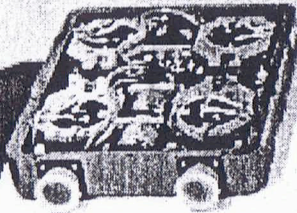

MC10 1952  
4 element-remote set  
Fuzing

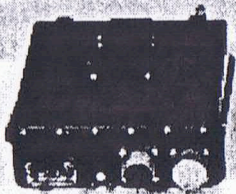

MC48 1952  
4 element-fixed  
Arming

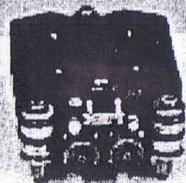

MC273 1954  
4 element-fixed  
Arming

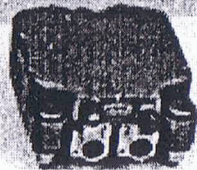

XMC157  
4 element-remote set  
1967 technology

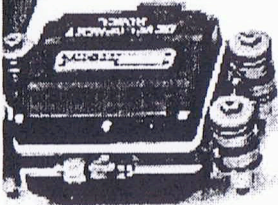

XMC586 1958  
4 element-remote set  
Fuzing

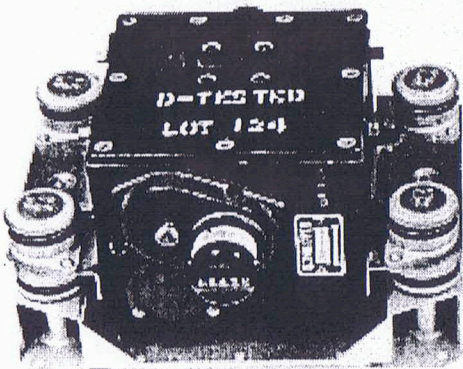

MC665 1957  
8 element-dial set  
Arming & Fuzing

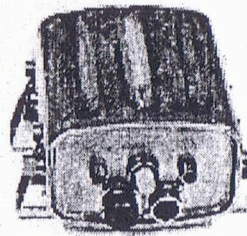

MC1266 1962  
4 element-remote set  
Arming & Fuzing

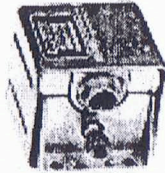

MC1312 1962  
4 element-fixed  
Option select

BAROMETRIC SWITCHES UNCLASSIFIED

BAROMETRIC SWITCHES UNCLASSIFIED

# Timers

---

- Reentry body fuzing
  - Primary fuze on older systems
  - High altitude fuze and/or backup to radar on recent systems
  - Candidate fuze for earth penetrating weapons
- Bomb fuzing
  - Also uses timer for safe escape in laydown mode
- Artillery projectiles and special munitions
- Depth bombs
  - Timer initiated by water impact or hydrostatic pressure

~~SECRET~~  
UNCLASSIFIED

~~SECRET~~  
UNCLASSIFIED

~~SECRET~~

UNCLASSIFIED

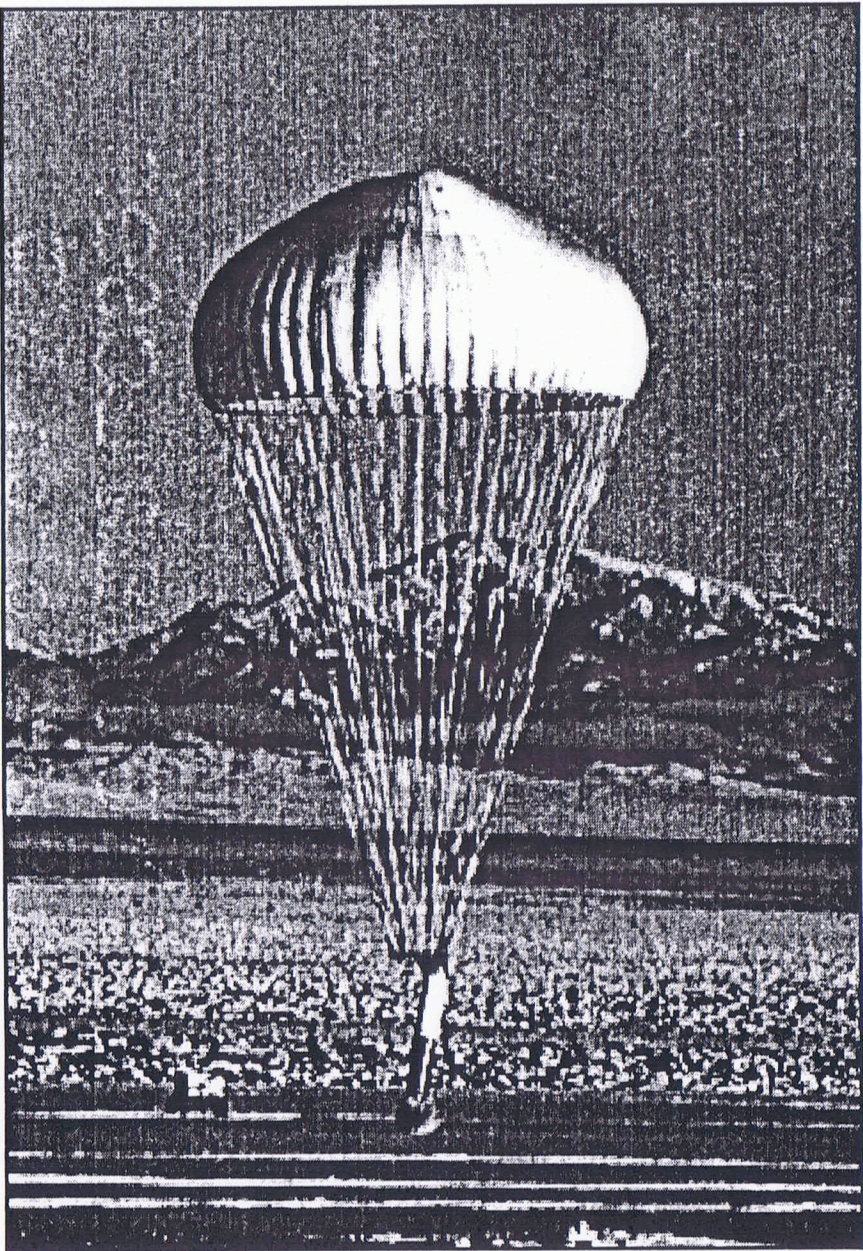

~~SECRET~~ UNCLASSIFIED

## Timers (cont'd)

---

- Mechanism for initiating arming functions, I.e., batteries
- Critical element of any programmer and/or computer for warheads, bombs, guidance platforms, etc.
- Technology evolution
  - Mechanical      Approximately 5% accuracy
  - Electronic (LC)      Smaller with approximately 2% accuracy
  - Crystal      Smallest with accuracy measured in parts million

~~SECRET~~  
UNCLASSIFIED

~~SECRET~~  
UNCLASSIFIED

# Some Clocks In Stockpile

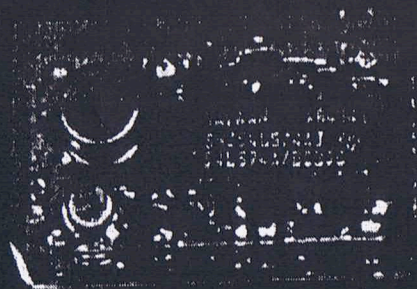

MC3648  
B61-7



MC3827  
Trident II



MC4178  
B61JTA

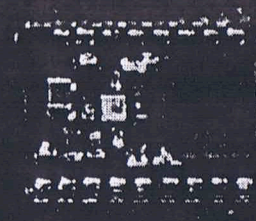

MC4081  
B61-3,4,10



MC3852  
Code  
Activated  
Processor

~~SECRET~~  
UNCLASSIFIED

~~SECRET~~  
UNCLASSIFIED

~~SECRET~~ UNCLASSIFIED

b (3)

UNCLASSIFIED

~~SECRET~~

## Stockpile Stewardship will require Maintenance, Refurbishment & Repair

### Future:

- Performance certification (both current & new)
- Design & manufacturing (when required)

### Environment:

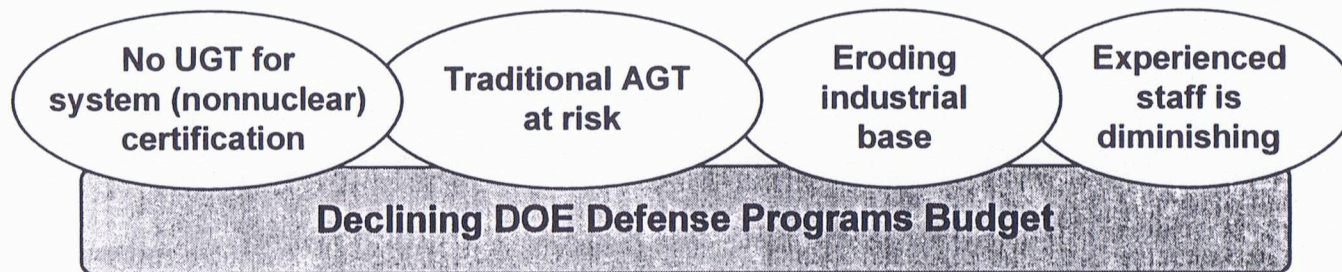

### Current need:

- Stockpile design options
- Capability sustainment

UNCLASSIFIED  
APPROPRIATE

UNCLASSIFIED  
APPROPRIATE



# SWPP DoD/DOE MOU (draft)

---

- Purpose for MOU

  - Program authorization

  - Roles & responsibilities

- Program Objectives

  - Exercise DOE capabilities relevant to SLBM

  - Demonstrate viability of system & component replacement options for W76 & W88

  - Emphasis on non-producible hardware and development of certification methods

  - Does not include fabrication of stockpile hardware

- Deliverable

  - Design Data Package for each option -- design definition, manufacturing & certification feasibility, identification of subsequent activities

UNCLASSIFIED

UNCLASSIFIED

# Reentry systems advanced AF&F project

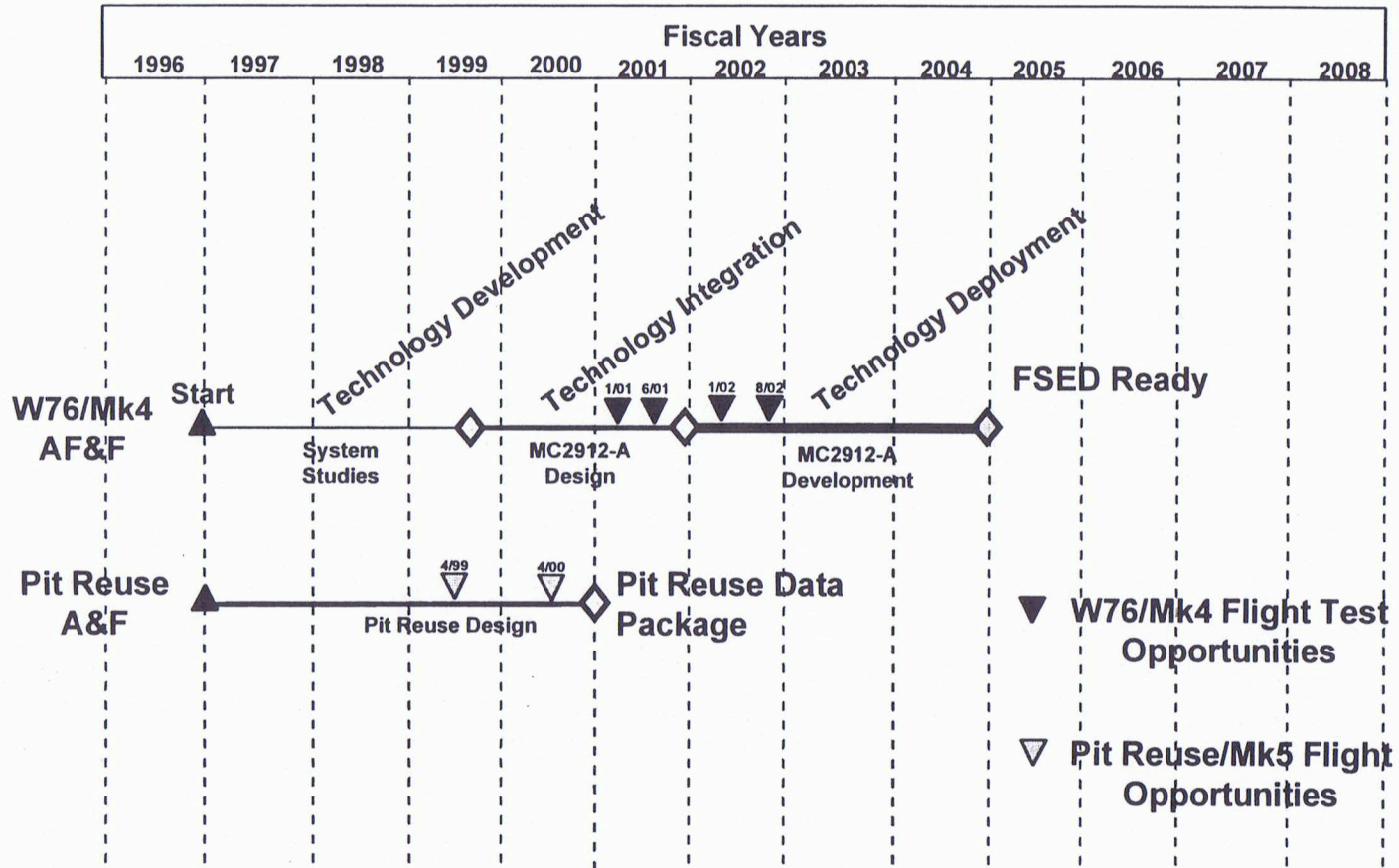

UNCLASSIFIED

UNCLASSIFIED

# Fuzing options for replacement Mk4 AF&F

---

## Mk4

---

- airburst radar, 3 ranges
- inertial airburst, g-started timer
- contact backup

## Mk5

---

- radar-update path length (RUPL)
- airburst radar, 5 ranges
- inertial airburst, path length
- high airburst, timer
- proximity radar
- contact backup

~~SECRET~~

UNCLASSIFIED

~~SECRET~~

UNCLASSIFIED

ARMOR

UNCLASSIFIED

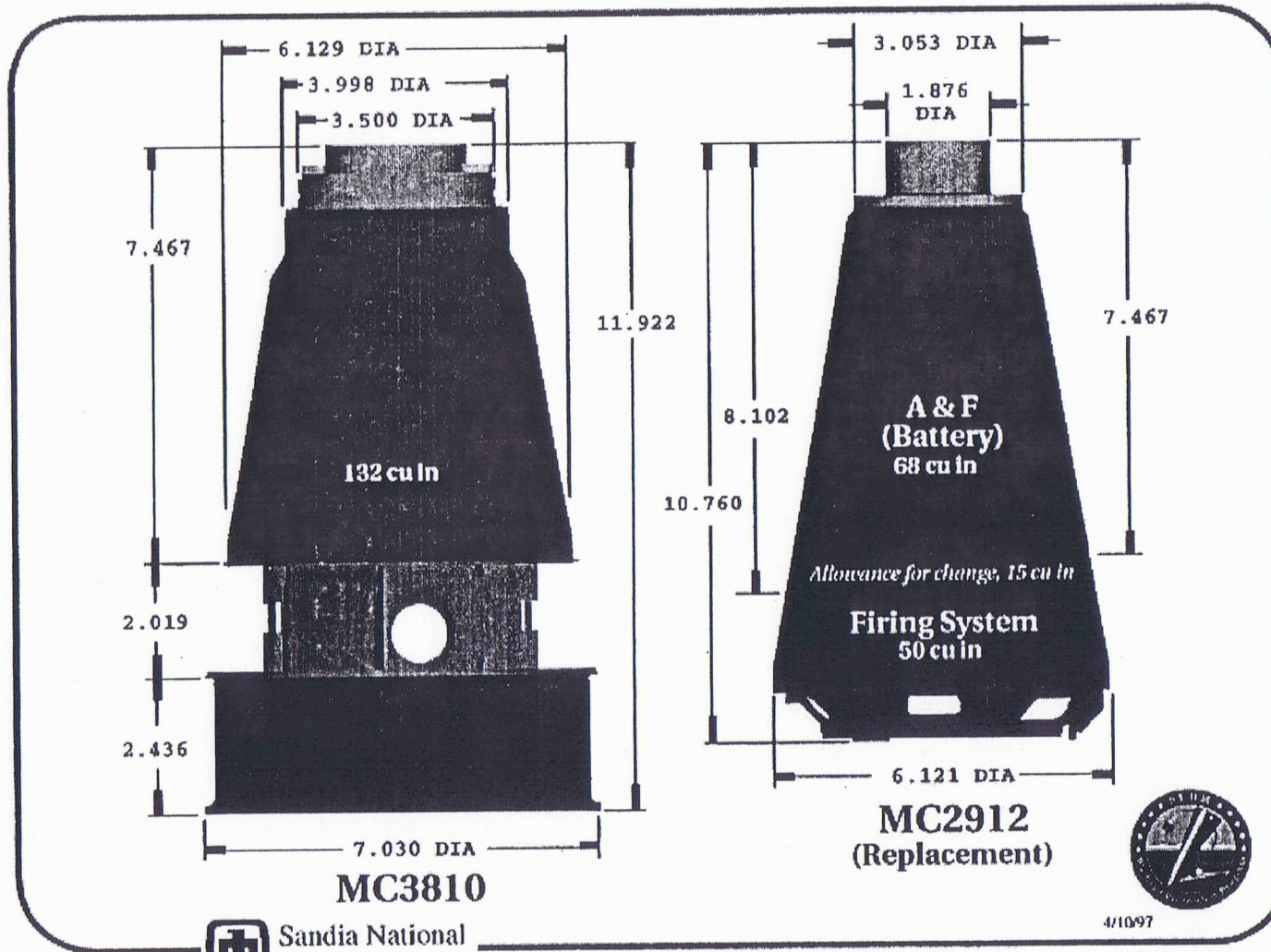

 Sandia National Laboratories



4/10/97

UNCLASSIFIED

ARMOR UNCLASSIFIED

# Fuzing options for replacement Mk4 AF&F

---

← eliminate long-life thermal battery

← dormant electronics during coast

← minimum perturbation to existing antennas & RF system

← reduced clock accuracy requirements

← reduced inertial sensor accuracy requirements

Mk4

← simplified processing

Mk5

← reduced non-volatile memory requirements

← nuclear safety upgrades enabled →

← improved instrumentation →

dependable surface fuzing →

new fuzing option for Mk4 →

← *reduced development & production costs*

ASBBB  
UNCLASSIFIED

ASBBB  
UNCLASSIFIED

# A&F architecture to support W76/Mk4 and Pit Reuse

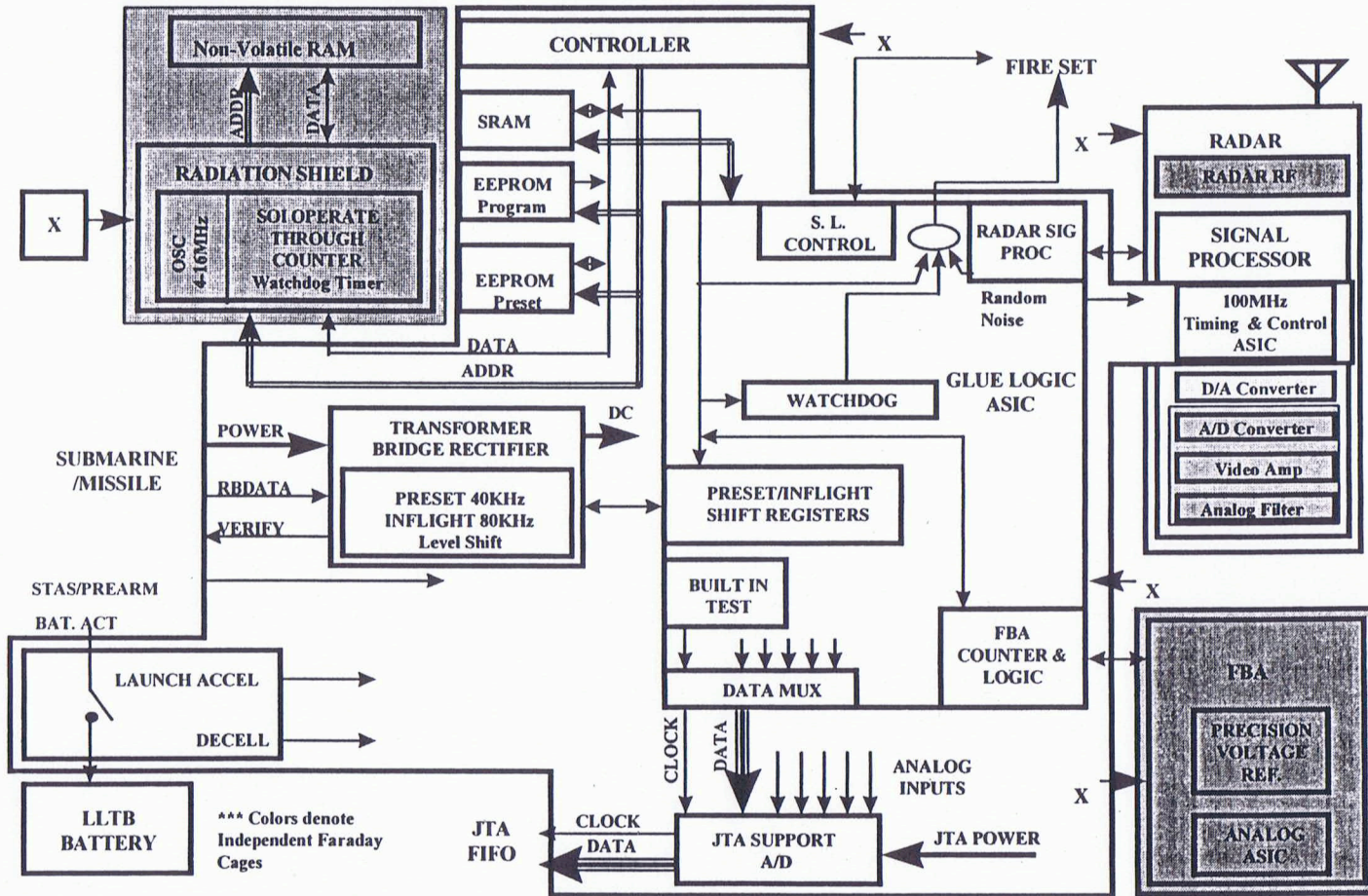

UNCLASSIFIED

UNCLASSIFIED

The following information is for reference only

~~SECRET~~ UNCLASSIFIED

UNCLASSIFIED

~~SECRET~~

b (3)

~~SECRET~~

UNCLASSIFIED

~~SECRET~~

UNCLASSIFIED



~~SECRET~~ UNCLASSIFIED

b (3)

UNCLASSIFIED

~~SECRET~~

b(3)

~~SECRET~~

UNCLASSIFIED

~~SECRET~~  
UNCLASSIFIED

~~SECRET~~  
UNCLASSIFIED

b (3)

UNCLASSIFIED

~~SECRET~~

~~SECRET~~  
UNCLASSIFIED

UNCLASSIFIED

~~SECRET~~

~~SECRET~~

UNCLASSIFIED

b (3)

UNCLASSIFIED

~~SECRET~~

b (3)

~~SECRET~~

UNCLASSIFIED

UNCLASSIFIED

~~SECRET~~

~~SECRET~~

~~UNCLASSIFIED~~

b (3)

UNCLASSIFIED

~~SECRET~~

576

b (3)

~~SECRET~~  
UNCLASSIFIED

UNCLASSIFIED

~~SECRET~~



~~SECRET~~

UNCLASSIFIED

b (3)

UNCLASSIFIED

~~SECRET~~

b (3)

~~SECRET~~

UNCLASSIFIED

~~SECRET~~

UNCLASSIFIED

~~SECRET~~

UNCLASSIFIED

b (3)

UNCLASSIFIED

~~SECRET~~

b (3)

~~SECRET~~

UNCLASSIFIED

UNCLASSIFIED

~~SECRET~~

# SURVEY OF WEAPONS DEVELOPMENT AND TECHNOLOGY

WR708

SESSION XV

•ARMS CONTROL ISSUES

~~SECRET~~  
UNCLASSIFIED

~~SECRET~~  
UNCLASSIFIED

# Strategic Delivery Systems

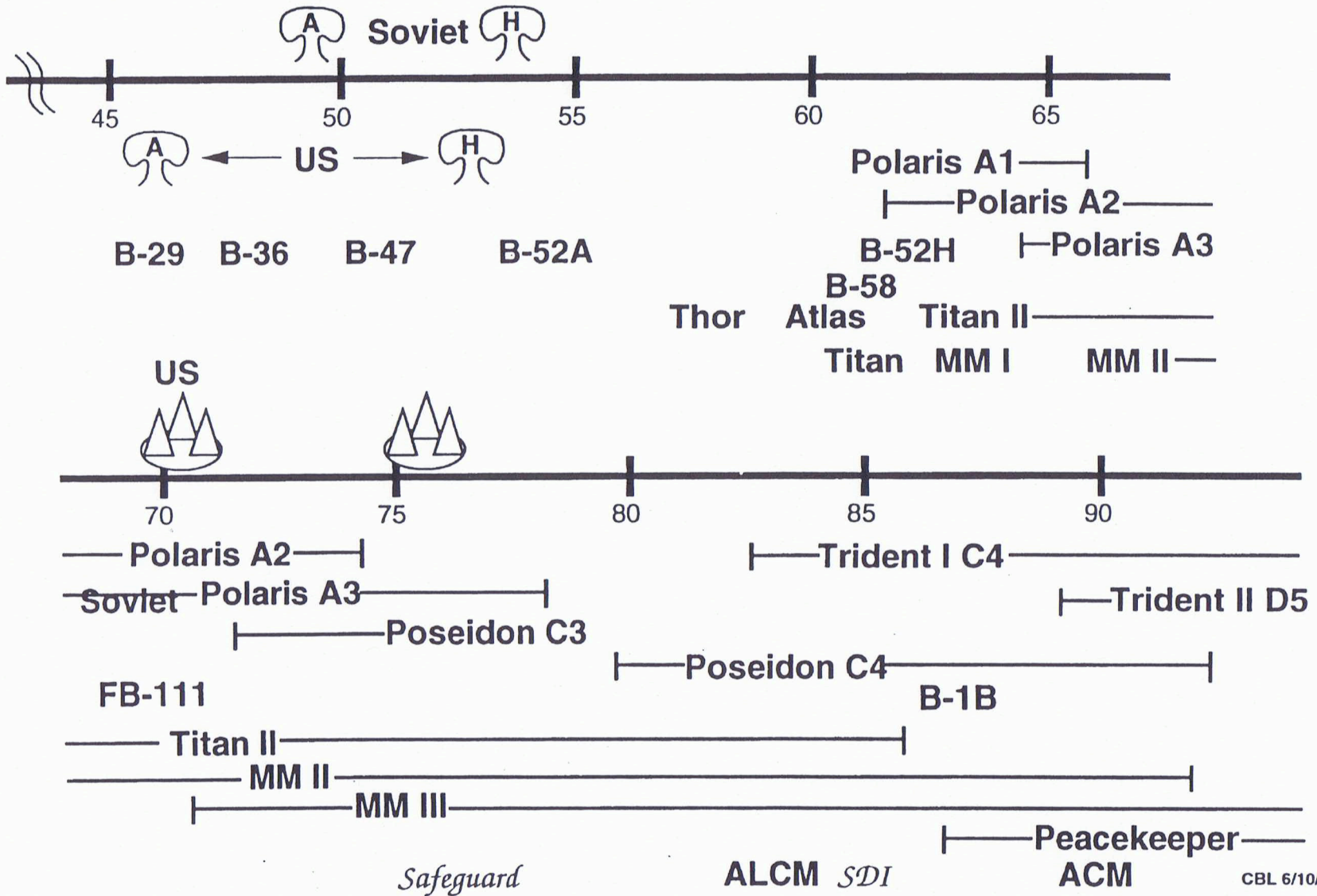

SECRET UNCLASSIFIED

SECRET UNCLASSIFIED

# The Evolution of Response Time

---

1948	Berlin blockade	2 days to assemble
1957	Suez	few hours to launch
1959	DEFCON established	
1960	JSTPS & SIOP	1/3 of bombers ready for immediate take-off
1962	Cuban missile crisis	1/8 on airborne alert

~~SECRET~~  
UNCLASSIFIED

~~SECRET~~  
UNCLASSIFIED

# Arms Control Treaties

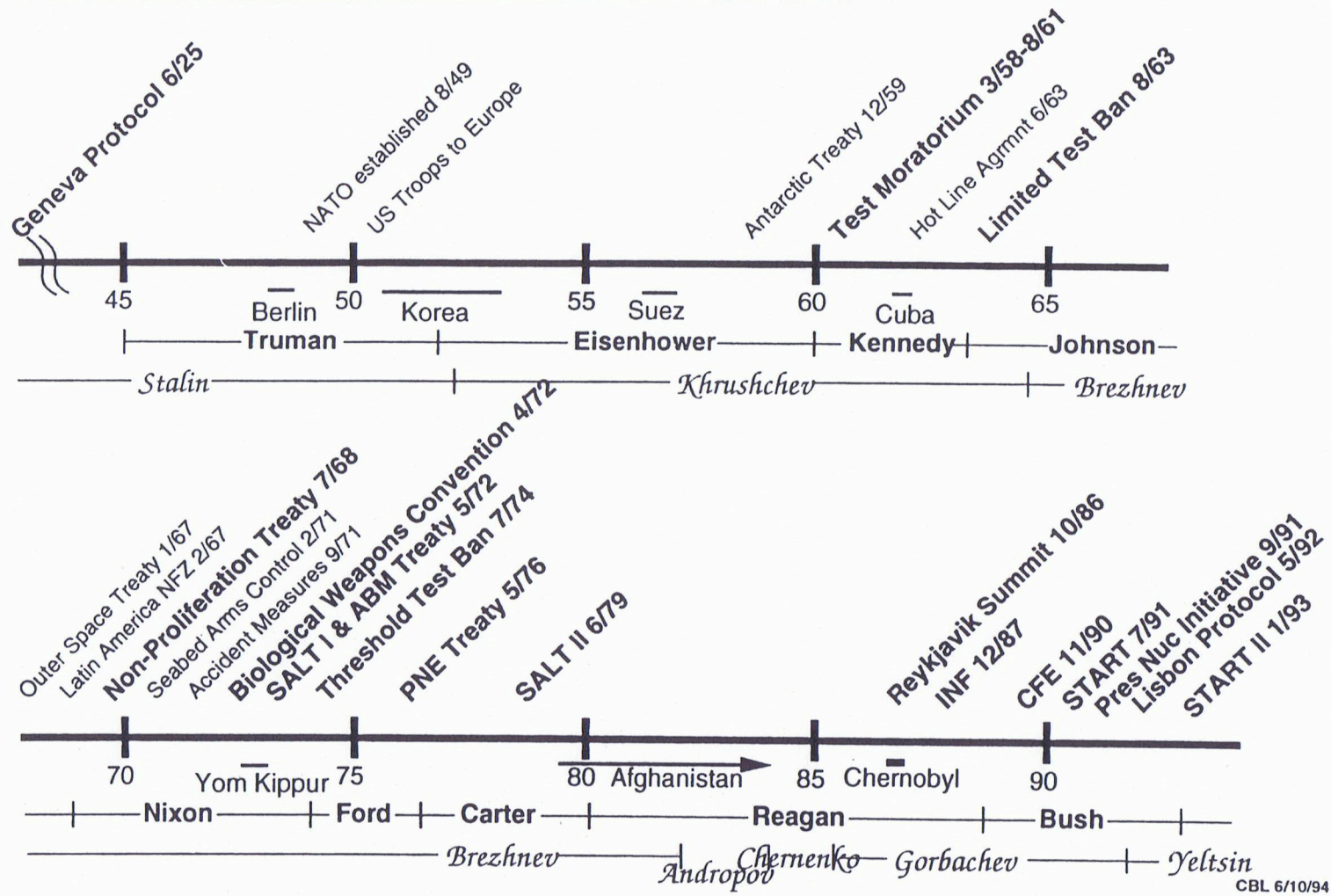

SECRET UNCLASSIFIED

SECRET UNCLASSIFIED



# The Geneva Protocol - 1925

---

Banned the use in war of asphyxiating, poisonous, or other gases and of bacteriological methods of warfare

US ratified in 1975

All major states now parties

UN Conference on Disarmament is working toward a ban on production and stockpiling

~~SECRET~~  
UNCLASSIFIED

~~SECRET~~  
UNCLASSIFIED

## **Test Moratorium - 1958 to 1961**

---

**In March 1958, Soviets declared moratorium**

**In October, negotiations on CTBT began &  
Eisenhower announced 1-yr U. S. moratorium**

**May 1960 U-2 incident scrubbed planned summit**

**Kennedy Administration resumed talks**

**August 1961, citing French test, Soviets resumed  
testing**

**Soviets conducted over 50 tests in the last 3 months of  
1961**

~~SECRET~~  
UNCLASSIFIED

~~SECRET~~  
UNCLASSIFIED

# **The Limited Test Ban Treaty - 1963**

---

**Limited nuclear tests to underground**

**Original signatories were US, Soviet Union, and UK**

**US ratified 10/63**

**More than 100 parties now**

**France ceased above ground tests in 1974,  
China in 1980**

~~SECRET~~

UNCLASSIFIED

~~SECRET~~

UNCLASSIFIED

# The Nonproliferation Treaty - 1968

---

- Eisenhower proposed "Atoms for Peace" in 1953
- IAEA established in 1957 to promote and monitor
- Nuclear Nonproliferation Treaty was negotiated from 1965 and signed in 1968
- NPT Review Conferences every 5 years
- After 25 years (April 1995) the Review and Extension Conference (Chaired by Amb. Dhanapala) decided on indefinite extension - without a vote
- In exchange for peaceful use of atomic energy, signatories agree to safeguards

~~SECRET~~  
UNCLASSIFIED

~~SECRET~~  
UNCLASSIFIED

## States not party to the NPT (as of 1/23/97)

---

- Brazil
- Cuba
- India
- Israel
- Macedonia
- Pakistan
- Serbia/Montenegro

~~SECRET~~  
UNCLASSIFIED

~~SECRET~~  
UNCLASSIFIED

CBL 5/28/97

## Biological and Toxin Weapons Convention

---

Outlaws development, production, stockpiling of all biological or toxin weapons and requires destruction of existing stocks

No specific verification provisions

Signed in 1972 and ratified by the US in 1975

Nixon ended US program in 1969 and destroyed stocks

Soviet incident at Sverdlovsk in 1979

~~SECRET~~  
UNCLASSIFIED

~~SECRET~~  
UNCLASSIFIED

# **SALT I - 1972**

---

**Interim Agreement on Strategic Offensive Arms**

**Limited launchers (silos and sub tubes) to the then current number**

**US - 1710**

**SU - 2347**

**Limit on heavy launchers (SS-9 and later SS-18)**

**Five year duration**

**US ratified in Oct 1972**

**Reagan repudiated SALT I and II in May 1986**

~~SECRET~~  
UNCLASSIFIED

~~SECRET~~  
UNCLASSIFIED

## Joint Statement on the ABM Treaty - March 21, 1997

---

- Preserve the ABM Treaty, prevent circumvention, and enhance viability
- TBM systems may be deployed, but must not threaten strategic nuclear forces
- TBM systems will not be deployed against each other (?)
- SCC to complete demarcation between TBM and ABM
  - target missile velocity < 5 km/s, range < 3500 km
  - no space based TBM interceptors based on OPP

~~SECRET~~  
UNCLASSIFIED

~~SECRET~~  
UNCLASSIFIED



# ABM Treaty - 1972

---

Johnson and McNamara tried to convince Kosygin at Glassboro to limit ABM systems - June 1967

US announced Sentinel program in September 1967

ABM talks were postponed by Soviet invasion of Czechoslovakia in 1968

Nixon changed concept to Safeguard, protecting ICBMs and Washington, DC

Treaty prevents defense of territory, limits to 2 sites with 100 interceptors, limits LPARS

Forbids mobile ABMS or sea, air, or space systems

OPP, Krasnoyarsk, SCC, capabilities questions

UNCLASSIFIED

UNCLASSIFIED

# Threshold Test Ban Treaty - 1974

---

Signatories are the US, Soviet Union, and UK

Limits nuclear tests to 150kT

Verification by NTM (seismic)

A two page treaty

Joint Verification Experiment in 1988

US ratified in 1989

SECRET  
UNCLASSIFIED

SECRET  
UNCLASSIFIED

# Peaceful Nuclear Explosives Treaty - 1976

---

Limited peaceful nuclear explosives to 150kT

Permitted maximum aggregate yield of 1.5 MT,  
with on site monitoring for yields above 150kT

Plugged a loophole in the TTBT

~~SECRET~~  
UNCLASSIFIED

~~SECRET~~  
UNCLASSIFIED

# SALT II - 1979

---

## Limited and reduced SNDVs

All SNDVs	2250	(2504 actual)
MIRVed ICSs, SLs, bombers	1320	
MIRVed ICs, SLs	1200	
MIRVed ICs	820	

One new type, no new heavies, MIRV limits

CM counting rules, FRODs, Backfire statement

Verification by NTM, no encryption

12/79 Afghanistan, withdrawn from ratification

"Fatally flawed," no undercut, then terminated 5/86

**REF ID: A60811**

UNCLASSIFIED

**REF ID: A60811**  
UNCLASSIFIED

~~SECRET~~

UNCLASSIFIED

DOE  
b(3)

UNCLASSIFIED

~~SECRET~~

# Conventional Forces in Europe - 1990

---

**MBFR talks ended after 15 years in February 1989**

**CFE talks formally opened March 1989, with the 23 members of NATO and the Warsaw Pact**

**Treaty signed November 1990**

**Treaty limits equipment in the Atlantic to the Urals (ATTU) region**

**Limits on tanks, artillery, ACVs, combat aircraft, attack helicopters**

**Wide-ranging and intrusive verification regime**

~~SECRET~~  
UNCLASSIFIED

~~SECRET~~  
UNCLASSIFIED

# START Treaty - 1991

---

Signed July 31, 1991, 5 months before the end of SU

Lisbon Protocol, signed May 1992, committed Russia, Ukraine, Belarus, and Kazakhstan to START (and NPT)

START limits SNDVs and deployed warheads:

	START	US forces*	Soviet forces*
SNDVs	1600	2246	2500
ICBM & SLBM Warheads	4900	8210	9416
Total Warheads	6000	10563	10271
Heavy ICBM Warheads	1540	-----	3080
Mobile ICBM Warheads	1100	-----	618
Throw-wt ICs & SLs	3600	2631	6626
(metric tons)			

\*as of 9/90

UNCLASSIFIED  
SECRET

UNCLASSIFIED  
SECRET

## Nuclear Posture Review - 9/94

---

- **Strategic Forces**
  - No more than 20 B-2 bombers
  - Reduce B-52 force from 94 to 66
  - Reduce Trident fleet from 18 to 14
  - Maintain single RV MM III
- **Non-Strategic Nuclear Forces**
  - Maintain European NSNF at current level  
( $<10\%$  of Cold War levels)
  - Eliminate nuclear weapons capability from surface Navy
  - Retain cruise missile capability on subs
  - Retain land-based DCA

~~SECRET~~  
UNCLASSIFIED

~~SECRET~~  
UNCLASSIFIED



# Comprehensive Test Ban Treaty - 200?

---

- **Adopted by the UNGA 9/10/96**
  - **CD could not reach consensus (India)**
- **EIF requires 44 states with reactors**
  - **includes India, Iran, Egypt, Israel, North Korea, Pakistan**
- **Activities not prohibited - finessed**
  - **US “true zero” yield**
- **Zero not verifiable, less than 1kT too expensive**
- **International Monitoring System**
  - **Seismic, Radionuclide, Hydroacoustic, Infrasound**
  - **OSI requires 30 of 51 Executive Council votes**

~~SECRET~~  
UNCLASSIFIED

~~SECRET~~  
UNCLASSIFIED

## START III - 200?

---

- Clinton and Yeltsin at Helsinki Summit, March 21, 1997
  - Immediate START III negotiations upon START II EIF
  - 2,000 - 2,500 strategic warheads by end of 2007
  - Transparency of strategic warhead inventories
  - Measures to promote irreversibility of warhead reductions
  - Deactivation of SNDVs under START II by end of 2003
  - Elimination deadline for SNDVs extended to end of 2007

*Joint Statement on Parameters on  
Future Reductions in Nuclear Forces*

~~SECRET~~

UNCLASSIFIED

~~SECRET~~  
UNCLASSIFIED

# The President's Nuclear Initiative-1991

---

## Sept 1991

Eliminate ground launched tactical nuclear weapons

Lance and AFAPs

Withdraw tactical nuclear weapons from surface ships, subs and P-3 bases

B-57, SLCM, B-61

Stand down strategic bombers from alert

Stand down MMII

Cancel mobility for PK and SICBM

Cancel SRAM II

Propose joint elimination of MIRVed ICBMs

## Jan 1992

Build only 20 B-2s

Cancel SICBM

Halt production of ACM

Halt production of W88 for Trident II

~~SECRET~~  
UNCLASSIFIED

~~SECRET~~  
UNCLASSIFIED

# START II - 1993

---

Treaty between the Russian Federation and US, signed by Bush and Yeltsin January 3, 1993, codified agreements of the Washington summit of June 17, 1992.

START II builds on START - and requires START

	<u>START</u>	<u>START II Ph1</u>	<u>START II Ph Ph2</u>
Start Warheads	6000	3800-4250	3000-3500
ICBM & SLBM Warheads	4900	no sublimit	no sublimit
MIRVed ICBM Warheads	N/A	1200	0
SLBM Warheads	N/A	2160	1700-1750
Heavy ICBM Warheads	1540	650	0
Mobile ICBM Warheads	1100	1100	1100

Phase one to be complete 7 years after entry-into-force,  
Phase two by 2003

UNCLASSIFIED

UNCLASSIFIED

# Comprehensive Test Ban

---

- Negotiations ongoing at the UN CD
- China testing through '96
- France resumed (8 tests) 9/95 - 5/96
- Activities not prohibited
  - US - "true zero"      UK - soon, US codes
  - France - OK                      Russia - eventually
  - China - waffling, still wants PNEs
- Zero not verifiable, less than 1kT too expensive
- International Monitoring System
  - Seismic - 50 stations, 50 - 150 auxiliaries
  - Radionuclide - Ba140, 75 - 100 stations, US wants Xe
  - Hydroacoustic
  - Infrasound - 50 - 60 stations
- Implementing agency - IAEA or ?

~~SECRET~~  
UNCLASSIFIED

~~SECRET~~  
UNCLASSIFIED

## Books of interest

---

**The Making of the Atomic Bomb**, Richard Rhodes, 1986.

Pulitzer prize winner, follows the scientific discoveries that led to the bomb, particularly good at the personalities involved, finishes with vivid descriptions of Hiroshima and Nagasaki. Excellent and entertaining.

**At the Highest Levels**, Michael R. Beschloss and Strobe Talbott, 1993.

Intimate details of the end of the Cold War, as seen at the top.

**Lenin's Tomb**, David Remnick, 1993.

Details the end of the Soviet Union from the viewpoint of the Russian people and their legacy. Choppy, but a very human picture of the great event.

**The Wizards of Armageddon**, Fred Kaplan, 1983.

Follows the policy and strategy decision regarding nuclear weapons, much emphasis on the early RAND personalities. Very good and readable.

SECRET  
UNCLASSIFIED

SECRET  
UNCLASSIFIED

# Nonproliferation

A New Challenge to the US Nuclear Weapon Program

SESSIONS XVI

John Taylor

National Security Policy Research Department

Sandia National Laboratories

~~SECRET~~

UNCLASSIFIED

~~SECRET~~  
UNCLASSIFIED

## Some Definitions

Proliferation is the spread of weapons of mass destruction (WMD)-- typically nuclear, biological, and chemical weapons--and the systems which deliver them.

Nonproliferation is the use of the full range of political, economic and military tools to prevent proliferation, reverse it diplomatically, or protect our interest against an opponent armed with WMD or missiles.

Counterproliferation measures are the activities of the DoD across the full range of U.S. efforts to combat proliferation.

SECRET  
UNCLASSIFIED

SECRET  
UNCLASSIFIED



# The Changing Context

**Old**

**New**

**Bipolar Rigidity**

**Predictable**

**Communism**

**U.S. Dominant Western Power**

**Fixed Alliances**

**"Good Guys and Bad Guys"**

**U.N. Paralyzed**

**Multipolar Complexity**

**Uncertain**

**Nationalism/Religious Extremists**

**U.S. Militarily No.1 - Not Economical**

**Ad Hoc Coalitions**

**"Grey Guys"**

**U.N. Viable**

*Ref.: National Security in the 1990s: Defining a New Basis for U.S. Military Forces, Rep. Les Aspin, Chrmn House Armed Services Committee, January 6, 1992*

**SECRET**

**UNCLASSIFIED**

**SECRET**  
**UNCLASSIFIED**

**Nonproliferation Initiative**

# The Changing Threat

**Old**

**New**

**Single (Soviet)**  
**Survival at Stake**  
**Known**  
**Deterrable**  
**Strategic Use of Nukes**  
**Overt**  
**Europe-Centered**  
**High Risk of Escalation**

**Diverse**  
**American Interests at Stake**  
**Unknown**  
**Non-Deterrable**  
**Terroristic Use of Nukes**  
**Covert**  
**Regional, Ill-Defined**  
**Little Risk of Escalation**

*Ref.: National Security in the 1990s: Defining a New Basis for U.S. Military Forces, Rep. Les Aspin, Chrmn House Armed Services Committee, January 6, 1992*

~~SECRET~~  
 UNCLASSIFIED

~~SECRET~~  
 UNCLASSIFIED

# A Snapshot of the World

- 253 Sovereign nations, dependent areas, etc.
- 189 (+) Countries
- 177 Members in the United Nations
- (171 Members in FIFA!)
  
- 60 conflicts in progress involving more than 130 states or subnational entities

~~SECRET~~  
TTNOT ASSIFIED

~~SECRET~~  
TTNOT ASSIFIED



## All the World's Conflicts - May 1996

Area	Countries	Intensity	Nature of Conflict
------	-----------	-----------	--------------------

### Summary and Analysis

#### Intensity by type and percent of total

High	1	(0)	1%	(0%)
Medium	17	(18)	28%	(30%)
Low	42	(40)	71%	(70%)
Totals	60	(58)		

Numbers in () from  
last reporting period (2/96).

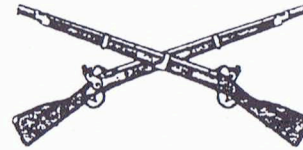

#### Number and Percentage by Conflict Type

Territory	15	28%
Ethnic	31	53%
Oil	4	7%
Civil War	30	52%
Religious	9	16%

#### Percent of Total by Region

Europe	12%
Latin America	19%
Africa	31%
Middle/Near East	12%
South Asia	8%
Southeast Asia	7%
Far East	10%



UNCLASSIFIED  
 UNCLASSIFIED  
 UNCLASSIFIED

UNCLASSIFIED  
 UNCLASSIFIED  
 UNCLASSIFIED

# Alva Myrdahl's Historical View of Nuclear Weapon Controls

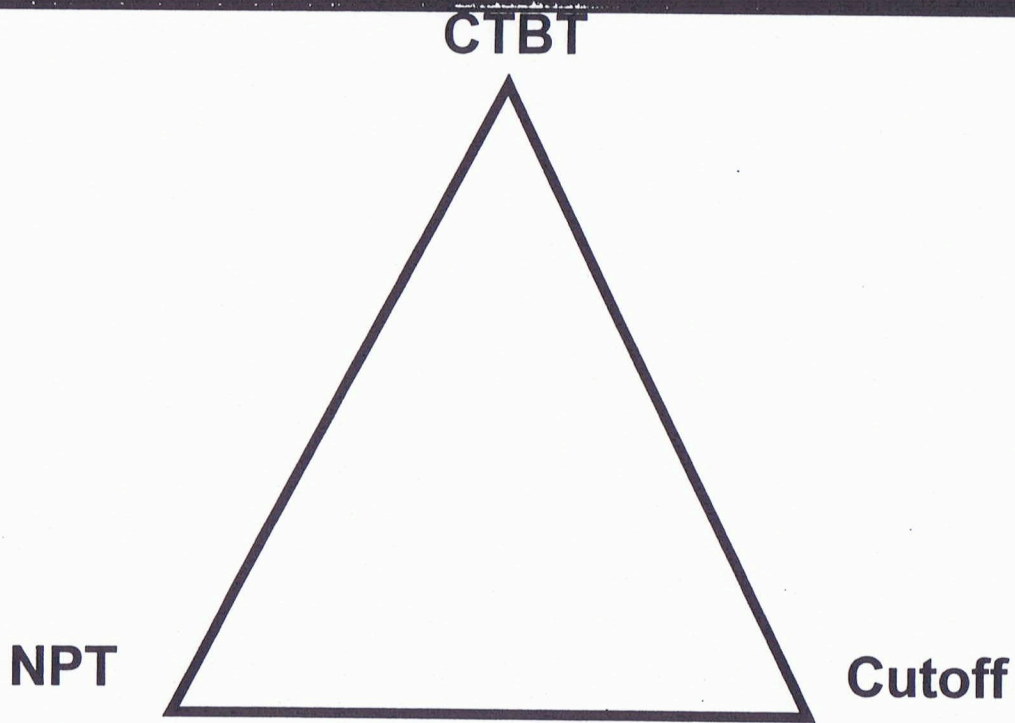

~~SECRET~~  
UNCLASSIFIED

~~SECRET~~  
UNCLASSIFIED

# What Constitutes a Weapon of Mass Destruction

- Indiscriminate nature of use
- Effect not confined to belligerents
- Excessive injury -- "cruel and unusual"
- Inability to defend against effectively
- Use would overwhelm medical and evacuation resources
- Notion of "terror"

~~SECRET~~  
UNCLASSIFIED

~~SECRET~~  
UNCLASSIFIED

## Motivation to Acquire Weapons of Mass Destruction

Great Powers have always countered the weapons of other great powers (e.g., USSR in the late 1940s)

Fear that a great power ally will not follow through (e.g., UK, France)

Fear over nuclear capabilities of potential adversaries (e.g., PRC, India, Pakistan, Iran, perhaps US in 1940s)

Fear of adversaries conventional strength (e.g., Israel, perhaps US in 1940s)

Cheaper than conventional defense (e.g., US in 1950s)





Desire for offensive capability (e.g., US in 1940s?)

Status in world or region (e.g., Iraq)

~~SECRET~~  
UNCLASSIFIED

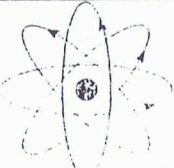
~~SECRET~~  
UNCLASSIFIED

## Some Proliferants of Concern

Country				
China				
India				
Iran				
Iraq				
Israel				
Libya				
Pakistan				
North Korea				
Russia				
Belarus, Kaz., Uk.				

	Thought to possess capability
	May possess capability
	Thought not to possess capability

UNCLASSIFIED

UNCLASSIFIED



## **“Cost Effectiveness” of Weapons of Mass Destruction**

**The cost of producing, storing and delivering weapons can be estimated as the amount of money to deliver one lethal dose.**

**For nuclear weapons = \$2000**

**For chemical weapons = \$100**

**For biological weapons = \$1**

~~SECRET~~  
UNCLASSIFIED

~~SECRET~~  
UNCLASSIFIED

# How many nuclear weapons states will there be in the year 2000?

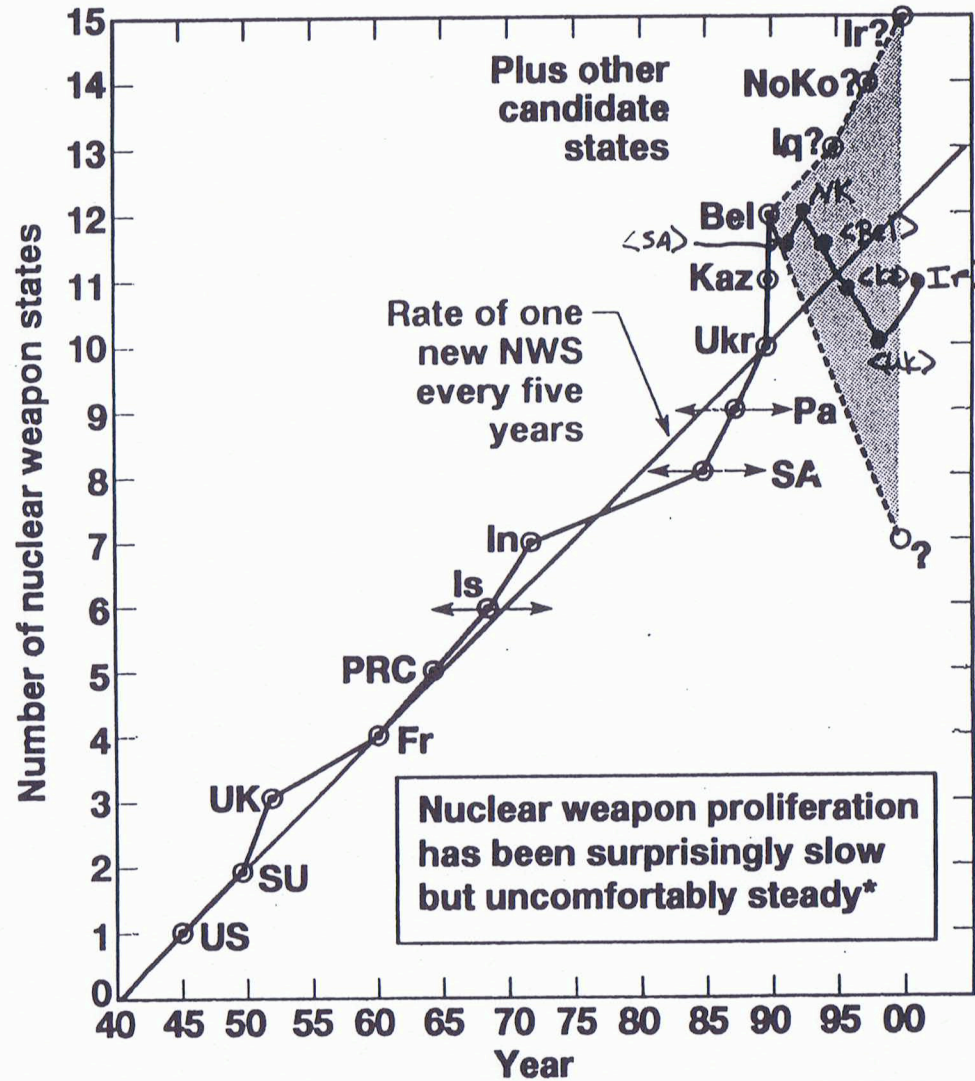

\*Data from news and journal articles in 1992

UNCLASSIFIED

UNCLASSIFIED

# Nuclear Proliferation: A Current Status

- **Acknowledged/Declared Nuclear Weapon States**
  - US, UK, China, France, Russia
- **Undeclared but widely suspected Nuclear Weapon States**
  - India, Pakistan, Israel
- **"Inheritors" of Soviet weapons**
  - Ukraine, Kazakhstan, Belarus
- **Virtual Nuclear Weapon States (e.g., weapon capabilities but no weapons)**
  - Japan, Germany
- **Threshold Nuclear Weapon States**
  - North Korea
- **Aspiring Proliferators**
  - Iraq, Iran, Libya, Algeria, various terrorist organizations
- **Rollback cases**
  - Argentina, Brazil, Sweden, Switzerland, Egypt, Taiwan, South Africa(?)

UNCLASSIFIED  
SECRET

UNCLASSIFIED  
SECRET

## There have been some Nonproliferation Successes

- Sweden abandoned its programs in the 1970s.
- South Africa stopped its programs in 1992 ( 6 weapons).
- Argentina and Brazil renounced their programs.
- Taiwan and South Korea abandoned their programs in the 1980s.
- Iraq's program "put on hold" by Desert Storm and UN Resolution 687 and 715.
- Belarus, Kazakhstan, and Ukraine (?) have agreed to return the FSU weapons to Russia.
- NPT indefinitely extended by "pseudo consensus"

UNCLASSIFIED  
SECRET

UNCLASSIFIED

SECRET

# WMD Technological Capabilities

**Nuclear:**

5 acknowledged possessors, 30 countries with "capability"

**Chemical:**

20-24 possessors, 80-90 countries and some subnational entities with "capability"

**Biological:**

10-12 possessors, virtually every state and several subnational entities are "capable"

**(Conventional weapons:**

virtually every country possess, 10-40 are major suppliers)

UNCLASSIFIED  
ALSO UNCLASSIFIED

UNCLASSIFIED  
ALSO UNCLASSIFIED

# Why Not Zero?

Many nations and individuals want us to completely eliminate weapons -- attractive philosophy but dubious policy:

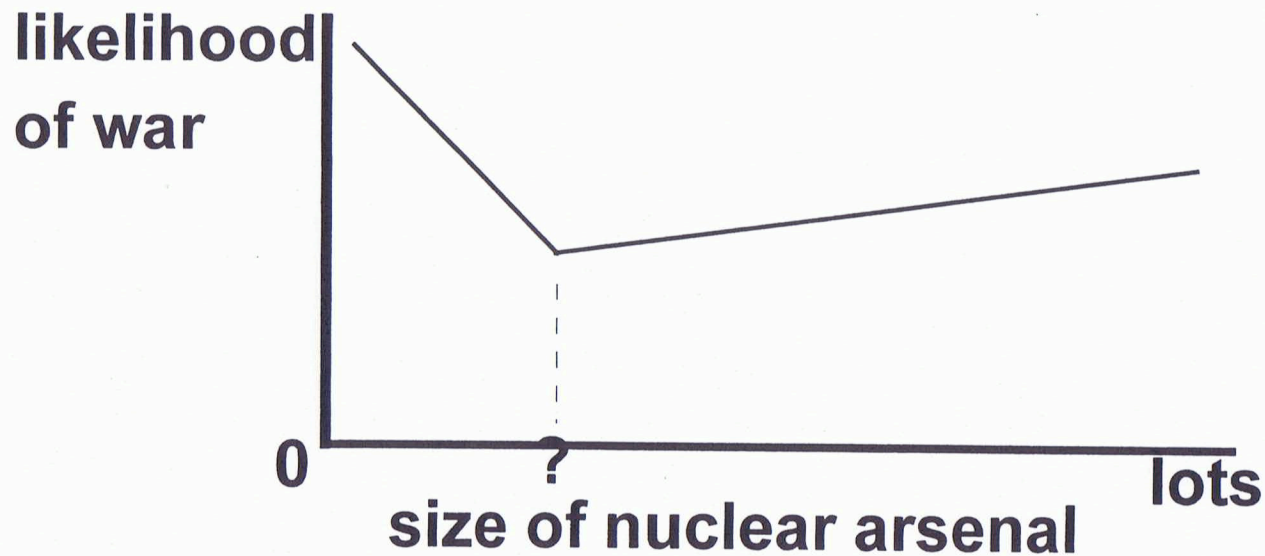

There may be things worse than nuclear weapons (e.g. biologics)

UNCLASSIFIED

UNCLASSIFIED

# Qualitative Level of Proliferation Concern

Cold War (20,000)

START I (10,000)

START II (5,000 $\pm$ 1500)

NAS (1,500)

Zero (0)



In the land of the blind, the one-eyed man is king.

SECRET  
UNCLASSIFIED

SECRET  
UNCLASSIFIED

*Nonproliferation Initiative*

# Options across the Nonproliferation -- Counterproliferation Spectrum

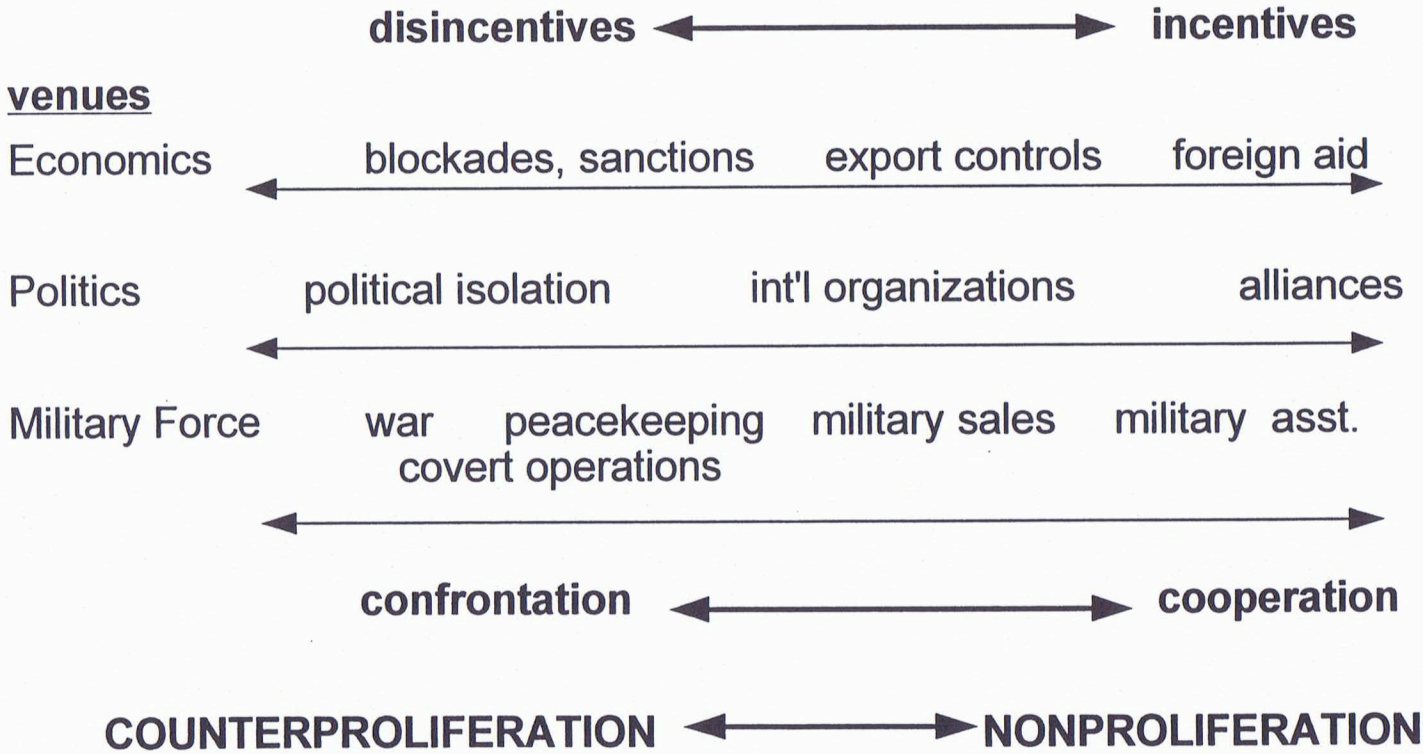

~~SECRET~~  
UNCLASSIFIED

~~SECRET~~  
UNCLASSIFIED



# Activities Which Accomplish Objectives

## Reduce Demand

- International agreements
- Regional security agreements
- Transparency and confidence building
- Responsible behavior by nuclear weapon states
- Penalties for violating international norms
- Minimizing utility

## Control Supply

- International Export Control Regimes
- IAEA Safeguards
- Elimination of sources of supply
- Monitoring and enforcement of export controls or embargoes
- Responsible behavior by nuclear weapon states

## Mitigate Consequences

- Sanctions and embargoes
- Military activities
- Covert operations

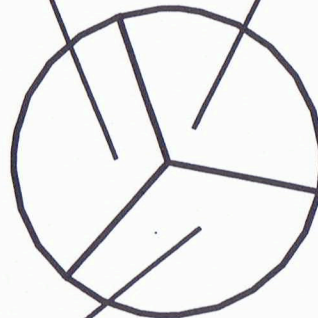

SECRET

UNCLASSIFIED

UNCLASSIFIED

SECRET

# Goals of Proliferation Controls (non → counter)

- REMOVE MOTIVATION FOR POSSESSION OF NUCLEAR WEAPONS
- INTERDICT DEVELOPMENT AND ACQUISITION
- DETER EMPLOYMENT OF KNOWN OR SUSPECTED STOCKPILES OF NUCLEAR WEAPONS
- ELIMINATE INFRASTRUCTURE BY PERSUASION, INTERNATIONAL SANCTIONS (e.g., Res 687)
- PROACTIVELY DESTROY FACILITIES (e.g., Osirak)

~~SECRET~~  
UNCLASSIFIED

~~SECRET~~  
UNCLASSIFIED

## Secondary Impacts of Nonproliferation Initiatives

- o NPT//NPT Extension Conference (1995):
  - Mandates for movement toward global reductions
  - Mandate for a CTB by 1996
  - Mandate for "FISS\_BAN"
  - Mandate for Negative Security Assurances
  - Improved Safeguards
- o Negotiations on control on fissile materials:
  - Codify in-place current US and Russian practices
  - Inspection regimes and transparency
  - Possible attempts to restrict tritium production
- o Export Controls
  - Heightened concern over "dual use" systems and commodities

UNCLASSIFIED  
REF ID: A60000

UNCLASSIFIED  
REF ID: A60000

## Issues on the Nonproliferation platter

- Control over the nuclear arsenal (and direction) of the FSU
- North Korea--good deal? bad deal?
- CTBT--linkage to NPT formalized during EXCON
- China, France--steadfastly continuing to test
- The Israeli nuclear arsenal
- The nuclear relationship between India and Pakistan--imminent missile deployment (M11 vs Prithvi)?
- Iran--a new reactor (Bushehr) for Israel to target?

~~SECRET~~

UNCLASSIFIED

~~SECRET~~  
UNCLASSIFIED

# SURVEY OF WEAPONS DEVELOPMENT AND TECHNOLOGY

WR708

## SESSION XVII

- STOCKPILE STEWARDSHIP
- SUMMARY/DISCUSSION

~~SECRET~~  
UNCLASSIFIED

~~SECRET~~  
UNCLASSIFIED

630

UNCLASSIFIED

~~SECRET~~

b (3)

~~SECRET~~ UNCLASSIFIED



### Mk Number Lifetime

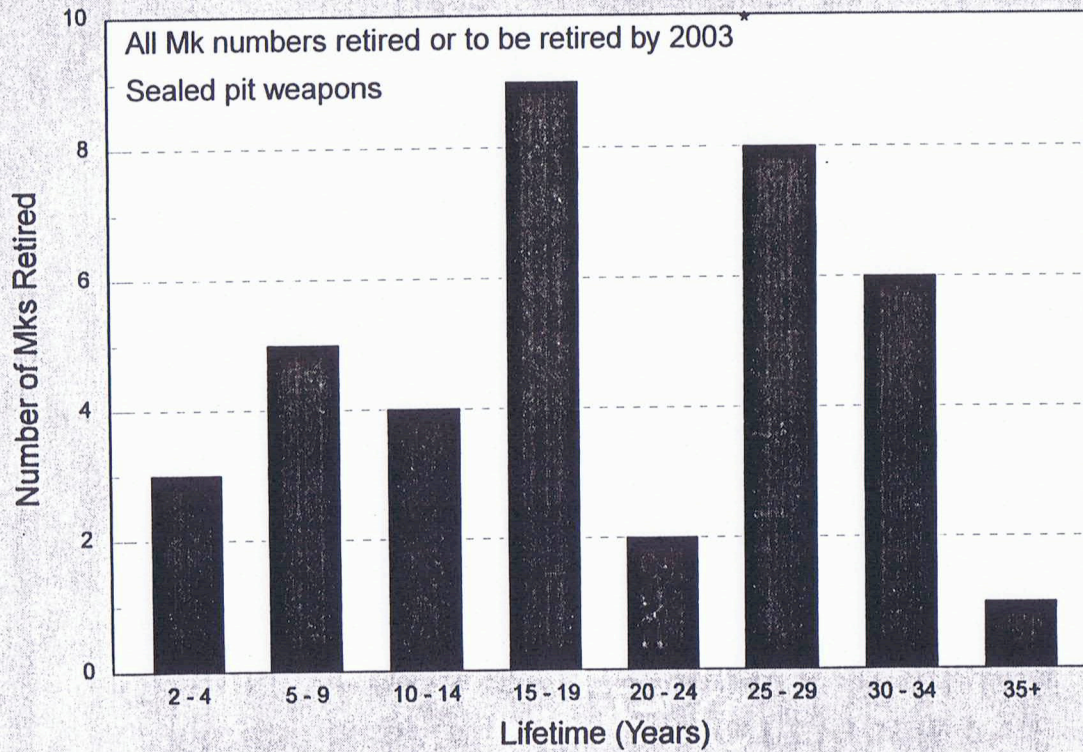

\* As projected by P&PD 94-0

~~SECRET~~

UNCLASSIFIED

~~SECRET~~  
UNCLASSIFIED

~~SECRET~~  
UNCLASSIFIED

UNCLASSIFIED

~~SECRET~~



~~SECRET~~ 2/8

UNCLASSIFIED

b (3)

UNCLASSIFIED

~~SECRET~~



## Weapon Histories Lead to a New Question

- "What is required to sustain a weapon while it is in the stockpile?"
  - The DOE has active programs to:
    - Upgrade a weapon's surety
    - Maintain a weapon's reliability
    - Incorporate new operational features into a weapon

UNCLASSIFIED  
SECRET

UNCLASSIFIED  
SECRET



# How Changes Are Made To Stockpiled Weapons

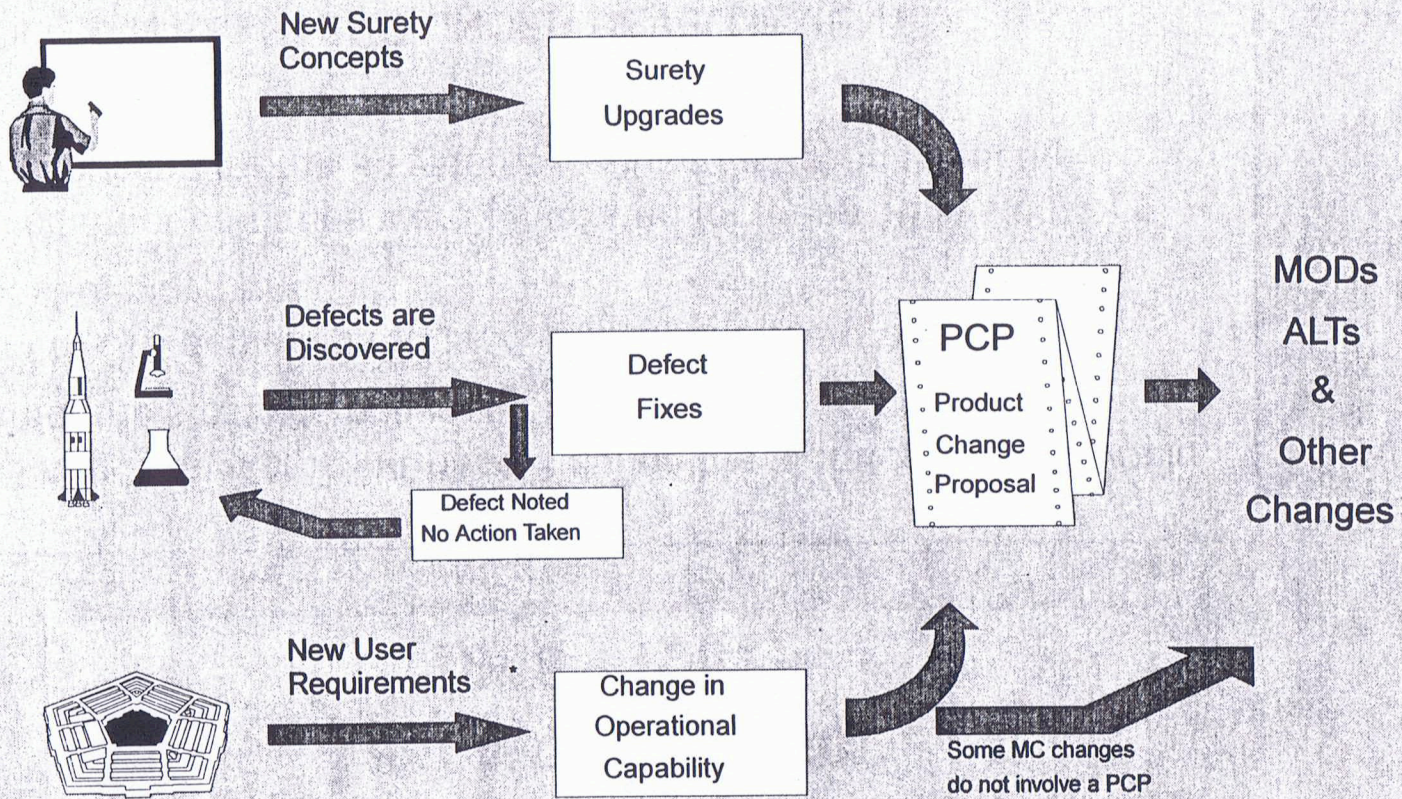

\* New user requirements may result in new weapon development

SECRET

UNCLASSIFIED

SECRET UNCLASSIFIED

b(3)

~~SECRET~~

UNCLASSIFIED

UNCLASSIFIED

~~SECRET~~



# The Stockpile Evaluation Process

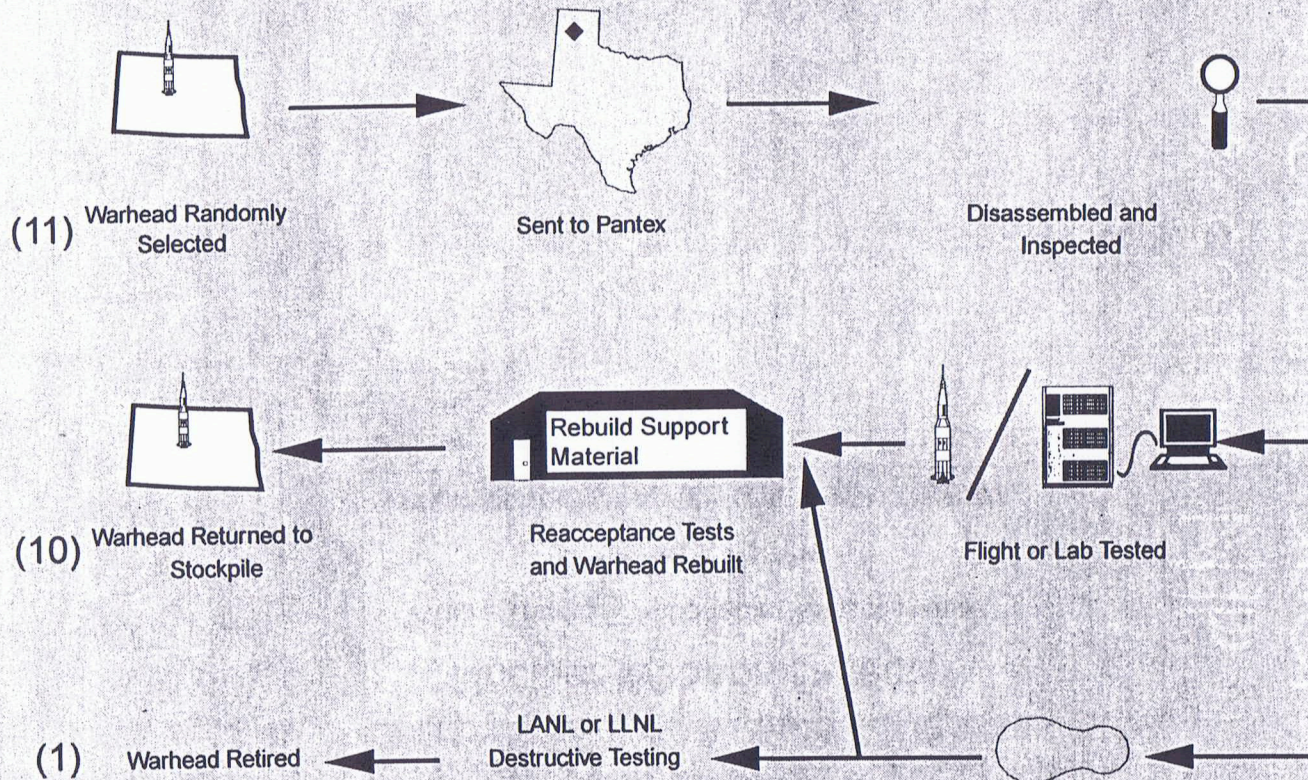

~~SECRET~~  
UNCLASSIFIED

~~SECRET~~  
UNCLASSIFIED



## Nuclear Weapon Defects

Where The 257 "Actionable" Defect Types  
Were First Discovered

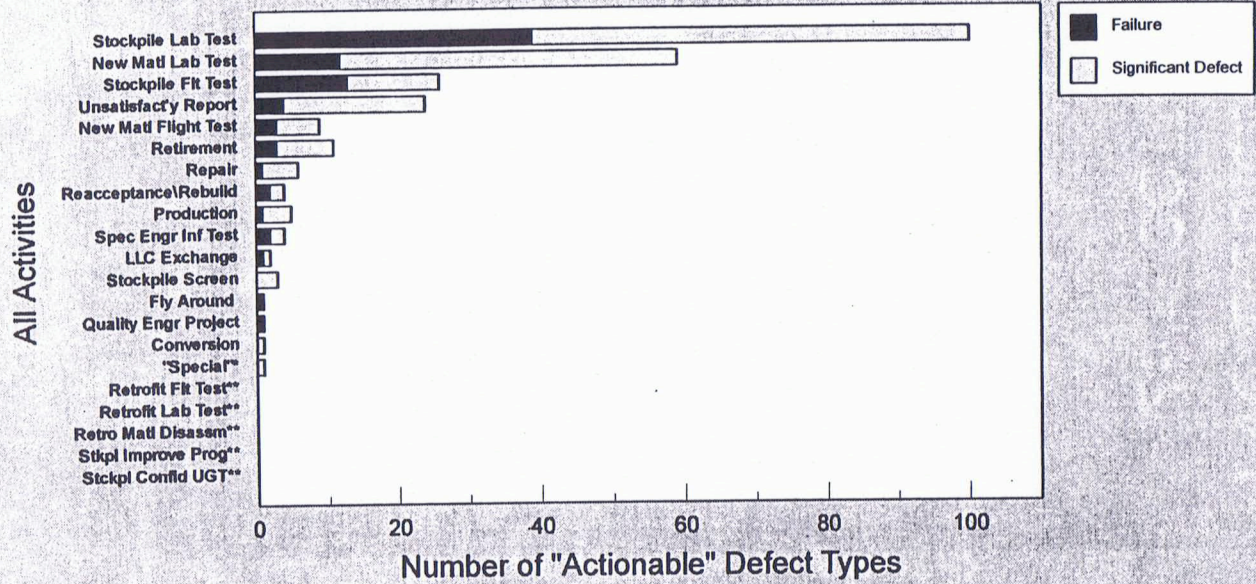

\* Designation in the Historical Summary  
 \*\* No "Actionable" Defect Types first discovered

UNCLASSIFIED  
 SECRET

UNCLASSIFIED  
 SECRET



## Reliability Impact Assessed For All Defects

- CONTINUAL PROCESS TO DEFINE WEAPON RELIABILITY -

- Reliability assessment first established during weapon development
  - \_ Reliability model developed

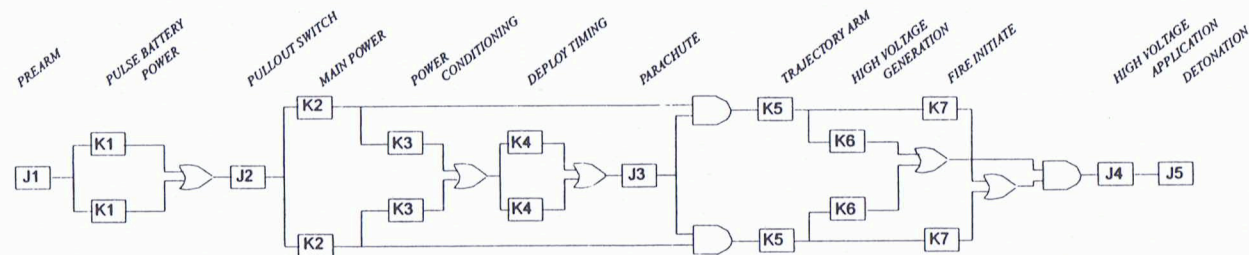

- \_ Sandia + Physics Lab inputs
- Reliability impact assessed during formal defect investigation (SFI)
  - \_ Data collected from relevant sources
  - \_ Added to existing data base
  - \_ New assessment made (some defects assessed with no reliability impact)



## PCP Includes MOD & ALT

- Product Change Proposal (PCP)
  - Initiates & authorizes any accountable change to a War-Reserve (WR) weapon & its associated gear or non-WR units
  - Range in importance from (H1324 for the W71) Change in Wrench
  - Normally includes MOD & ALT
- Modification Number (MOD)
  - Assigned to any change to a WR weapon that alters its operational capability
- Alteration Number (ALT)
  - Assigned to any accountable change to a WR weapon & its associated gear or non-WR units

REF ID: A600000

UNCLASSIFIED

REF ID: A600000

UNCLASSIFIED





## 'Major' PCPs (1970 - 1993)

67 PCPs by Type of Change

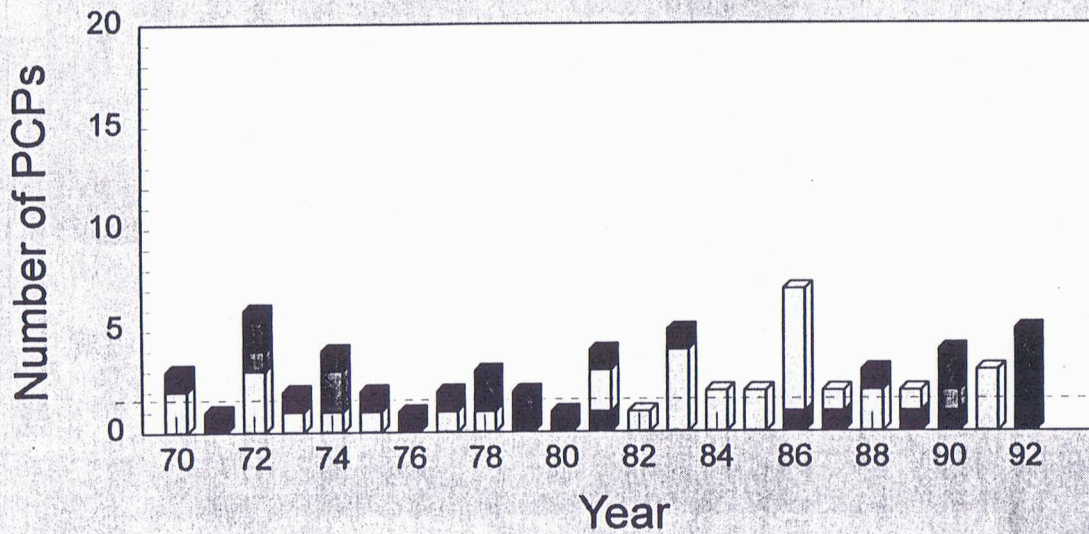

■ Safety (19%)      □ Reliability (51%)  
■ Command & Control (6%)      ■ Operational & Maintenance (24%)

~~SECRET~~  
UNCLASSIFIED

~~SECRET~~  
UNCLASSIFIED



# Stockpile Weapons in 2004

"Major" (26) PCPs by Type of Change

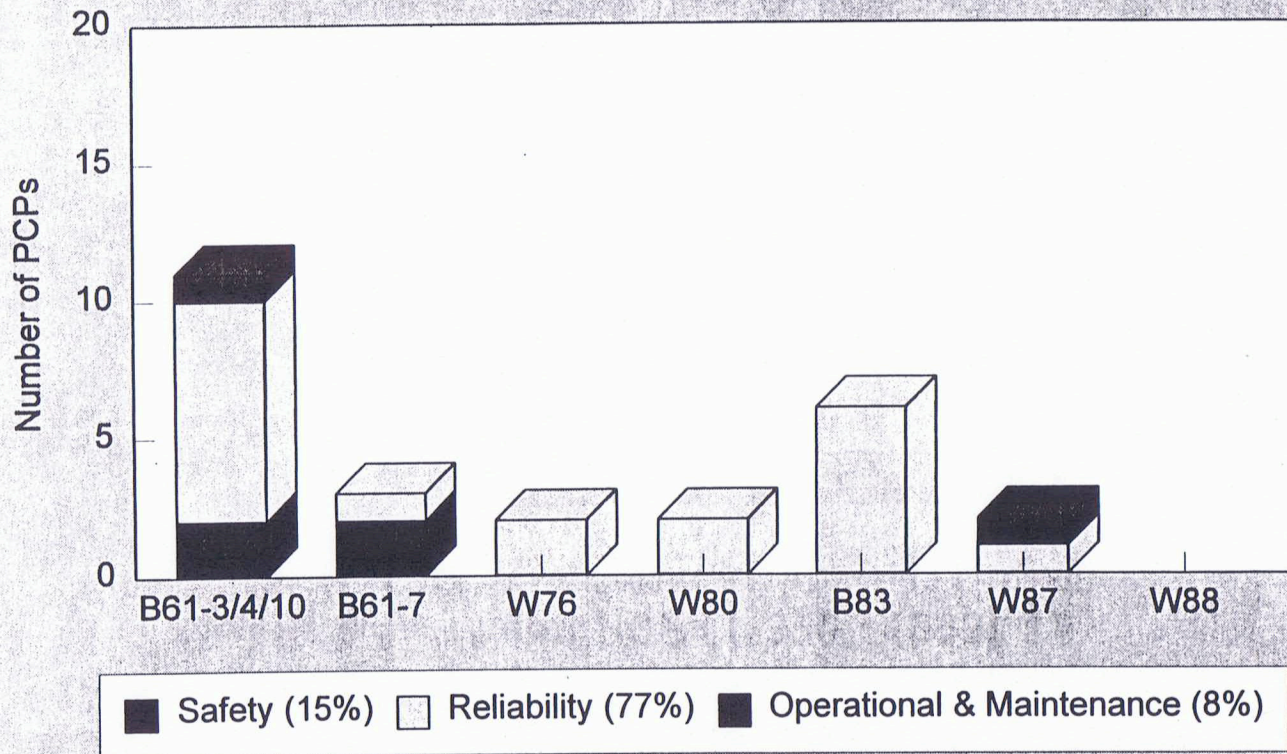

UNCLASSIFIED

UNCLASSIFIED



## Future Workload Issues

historical data suggest that:

- 1 "actionable" defect will be discovered each year.
- About 2 PCPs will be approved each year - 1 of these will constitute a major change.

DOD

SECRET

UNCLASSIFIED

SECRET  
UNCLASSIFIED



# 257 "Actionable" Defect Types Grouped By Design Skill Categories

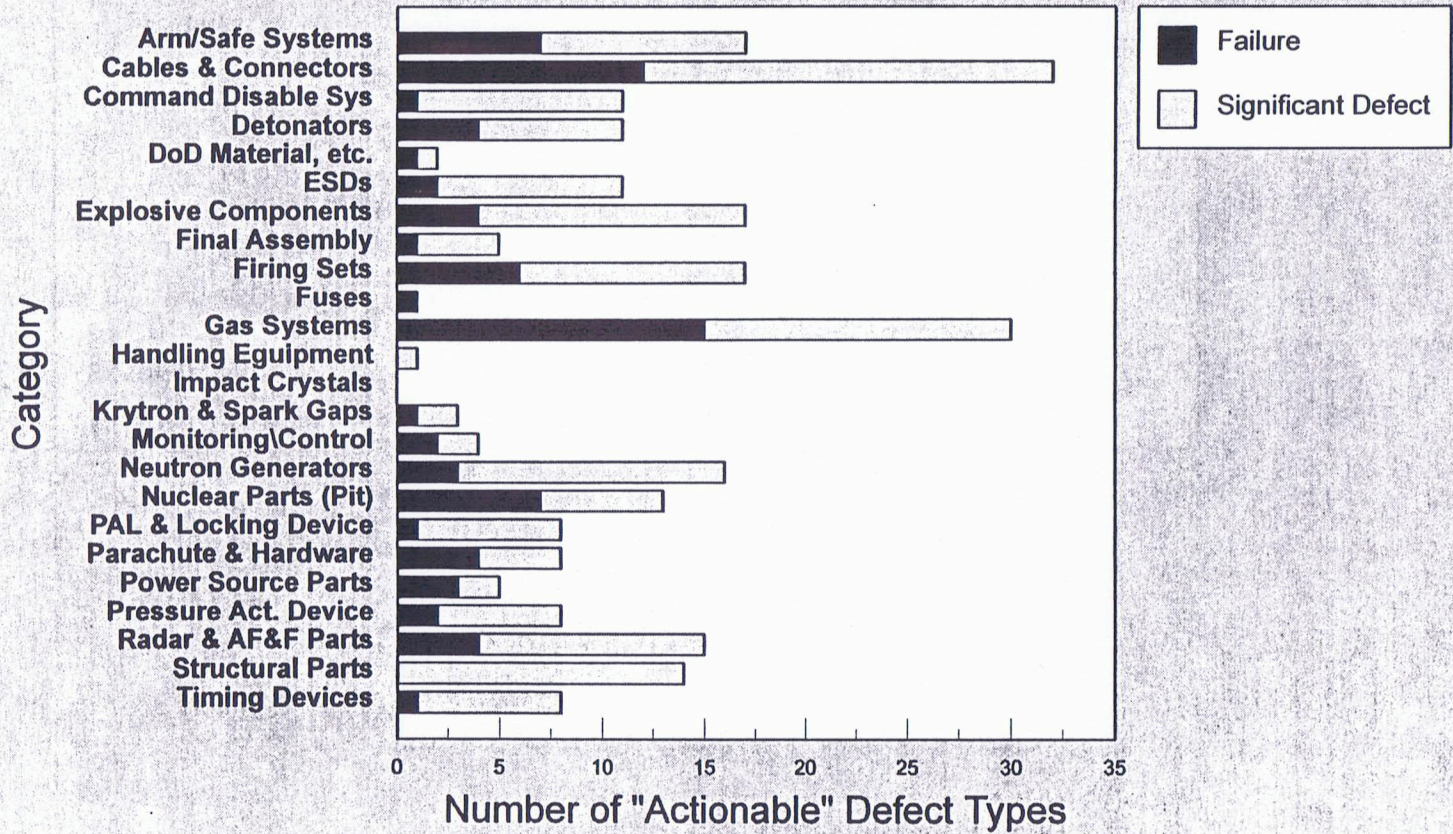

UNCLASSIFIED

UNCLASSIFIED

~~SECRET~~ UNCLASSIFIED

b(3)

UNCLASSIFIED

~~SECRET~~

b(3)

646

~~SECRET~~ UNCLASSIFIED

UNCLASSIFIED

~~SECRET~~

## REFERENCES

- Nuclear Weapons Production and Planning Directive (P & PD), (MA)
- Annual Weapons Program Report (AL)
- Nuclear Weapons Characteristics Report HQ DNA-48M
- Individual Weapon Development Reports
- History Of The Nuclear Weapons Stockpile OMA, SRD (1992)
- AL Workload Planning Guidance AWLPG, SRD

~~SECRET~~  
UNCLASSIFIED

~~SECRET~~  
UNCLASSIFIED

THIS PAGE LEFT BLANK INTENTIONALLY

~~SECRET~~  
UNCLASSIFIED

~~SECRET~~  
UNCLASSIFIED



# SURVEY OF WEAPONS DEVELOPMENT AND TECHNOLOGY

WR708

SESSION XVIII

- FIELD TRIP TO THE DEFENSE NUCLEAR WEAPONS SCHOOL'S

WEAPON DISPLAY AREA

~~SECRET~~  
UNCLASSIFIED

~~SECRET~~  
UNCLASSIFIED

Total pages 650, February 16, 1998  
Subject: Survey of Weapon Development and Technology (WR708) (U)

Distribution:  
1 thru 50 3524 Belinda Holley

~~SECRET~~

UNCLASSIFIED

~~SECRET~~ UNCLASSIFIED