

Review for the Final Exam

Stephen A. Edwards

Columbia University

Spring 2021



Table of Contents I

The Final Exam

Structure of a Compiler

Scanning

Languages and Regular Expressions

NFAs

Translating REs into NFAs

Building a DFA from an NFA: Subset Construction

Parsing

Resolving Ambiguity

Rightmost and Reverse-Rightmost Derivations

Building the LR(0) Automaton

First and Follow

Building an SLR Parsing Table

Shift/Reduce Parsing

Table of Contents II

Normal vs. Applicative Order Evaluation

Runtime Environments

- Storage Classes and Memory Layout

- The Stack and Activation Records

- The Heap

- Automatic Garbage Collection

- Objects and Inheritance

Table of Contents III

Code Generation

- Intermediate Representations
- Optimization and Basic Blocks

The Lambda Calculus

- Lambda Expressions
- Beta-reduction
- Alpha-conversion
- Reduction Order
- Normal Form
- The Y Combinator

The Final

120 minutes

24-hour window on Friday, April 16th

Download and submit to Gradescope

Closed book, notes, Internet

One 8-page PDF file of notes of your own devising. Upload these to Courseworks separately

Comprehensive: Anything discussed in class is fair game

Little, if any, programming. This is not a test on OCaml

Details of OCaml/C/C++/Java syntax not required

See the cover sheet for details

Compiling a Simple Program

```
int gcd(int a, int b)
{
    while (a != b) {
        if (a > b) a -= b;
        else b -= a;
    }
    return a;
}
```

What the Compiler Sees

```
int gcd(int a, int b)
{
    while (a != b) {
        if (a > b) a -= b;
        else b -= a;
    }
    return a;
}
```

```
i n t s p g c d ( i n t s p a , s p i
n t s p b ) n l { n l s p s p w h i l e s p
( a s p ! = s p b ) s p { n l s p s p s p s p i
f s p ( a s p > s p b ) s p a s p - = s p b
; n l s p s p s p e l s e s p b s p - = s p
a ; n l s p s p } n l s p s p r e t u r n s p
a ; n l } n l
```

Text file is a sequence of characters

Lexical Analysis Gives Tokens

```
int gcd(int a, int b)
{
  while (a != b) {
    if (a > b) a -= b;
    else b -= a;
  }
  return a;
}
```



int	gcd	(int	a	,	int	b)	{	while	(a		
!=	b)	{	if	(a	>	b)	a	-=	b	;	else
b	-=	a	;	}	return	a	;	}						

A stream of tokens. Whitespace, comments removed.

Parsing Gives an Abstract Syntax Tree

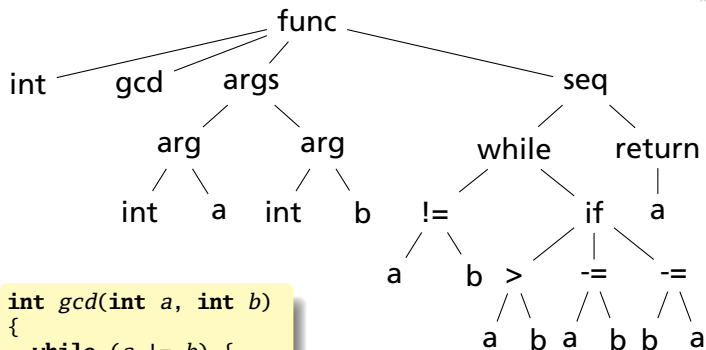

```
int gcd(int a, int b)
{
    while (a != b) {
        if (a > b) a -= b;
        else b -= a;
    }
    return a;
}
```

Semantic Analysis Resolves Symbols and Checks Types

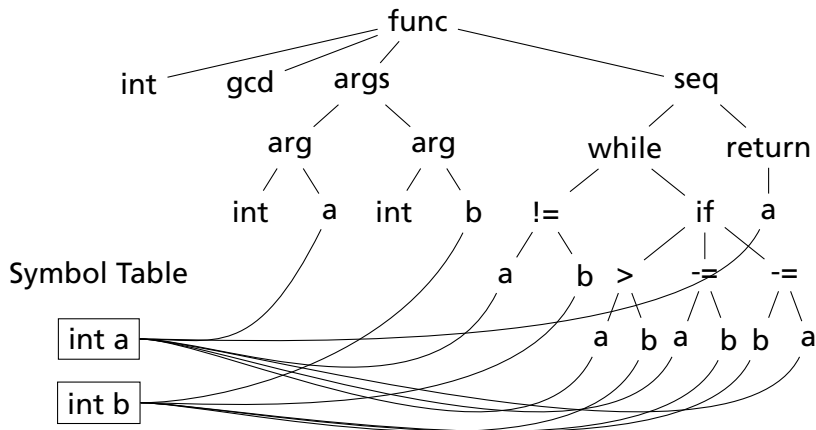

Translation into 3-Address Code

```
L0: sne    $1, a, b
      seq  $0, $1, 0
      btrue $0, L1    # while (a != b)
      sl   $3, b, a
      seq  $2, $3, 0
      btrue $2, L4    # if (a < b)
      sub  a, a, b    # a -= b
      jmp  L5
L4: sub  b, b, a    # b -= a
L5: jmp  L0
L1: ret   a
```

```
int gcd(int a, int b)
{
  while (a != b) {
    if (a > b) a -= b;
    else b -= a;
  }
  return a;
}
```

Idealized assembly language w/
infinite registers

Generation of 80386 Assembly

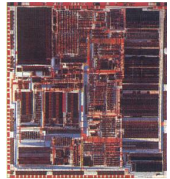

```
gcd:  pushl %ebp          # Save BP
      movl %esp,%ebp
      movl 8(%ebp),%eax # Load a from stack
      movl 12(%ebp),%edx # Load b from stack
.L8:  cmpl %edx,%eax
      je .L3           # while (a != b)
      jle .L5          # if (a < b)
      subl %edx,%eax   # a -= b
      jmp .L8
.L5:  subl %eax,%edx   # b -= a
      jmp .L8
.L3:  leave            # Restore SP, BP
      ret
```

Describing Tokens

Alphabet: A finite set of symbols

Examples: $\{ 0, 1 \}$, $\{ A, B, C, \dots, Z \}$, ASCII, Unicode

String: A finite sequence of symbols from an alphabet

Examples: ϵ (the empty string), Stephen, $\alpha\beta\gamma$

Language: A set of strings over an alphabet

Examples: \emptyset (the empty language), $\{ 1, 11, 111, 1111 \}$, all English words, strings that start with a letter followed by any sequence of letters and digits

Operations on Languages

Let $L = \{ \epsilon, wo \}$, $M = \{ man, men \}$

Concatenation: Strings from one followed by the other

$LM = \{ man, men, woman, women \}$

Union: All strings from each language

$L \cup M = \{ \epsilon, wo, man, men \}$

Kleene Closure: Zero or more concatenations

$M^* = \{ \epsilon \} \cup M \cup MM \cup MMM \dots =$
 $\{ \epsilon, man, men, manman, manmen, menman, menmen,$
 $manmanman, manmanmen, manmenman, \dots \}$

Regular Expressions over an Alphabet Σ

A standard way to express languages for tokens.

1. ϵ is a regular expression that denotes $\{\epsilon\}$
2. If $a \in \Sigma$, a is an RE that denotes $\{a\}$
3. If r and s denote languages $L(r)$ and $L(s)$,
 - ▶ $(r) | (s)$ denotes $L(r) \cup L(s)$
 - ▶ $(r)(s)$ denotes $\{tu : t \in L(r), u \in L(s)\}$
 - ▶ $(r)^*$ denotes $\cup_{i=0}^{\infty} L^i$ ($L^0 = \{\epsilon\}$ and $L^i = LL^{i-1}$)

Nondeterministic Finite Automata

"All strings containing an even number of 0's and 1's"

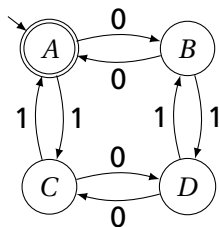

1. Set of states

$$S: \left\{ \textcircled{\textcircled{A}} \textcircled{B} \textcircled{C} \textcircled{D} \right\}$$

2. Set of input symbols $\Sigma: \{0, 1\}$

3. Transition function $\sigma: S \times \Sigma_c \rightarrow 2^S$

state	ϵ	0	1
A	\emptyset	{B}	{C}
B	\emptyset	{A}	{D}
C	\emptyset	{D}	{A}
D	\emptyset	{C}	{B}

4. Start state $s_0: \textcircled{\textcircled{A}}$

5. Set of accepting states

$$F: \left\{ \textcircled{\textcircled{A}} \right\}$$

The Language induced by an NFA

An NFA accepts an input string x iff there is a path from the start state to an accepting state that "spells out" x .

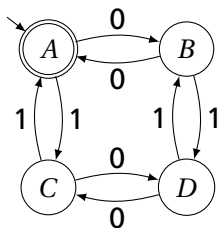

Show that the string "010010" is accepted.

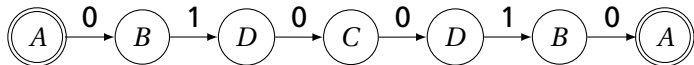

Translating REs into NFAs

a



Symbol

$r_1 r_2$

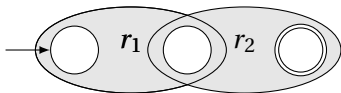

Sequence

$r_1 | r_2$

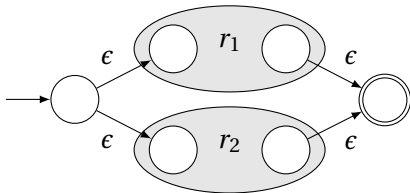

Choice

$(r)^*$

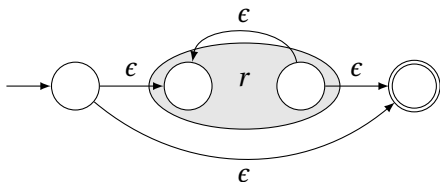

Kleene Closure

Translating REs into NFAs

Example: Translate $(a|b)^*abb$ into an NFA. Answer:

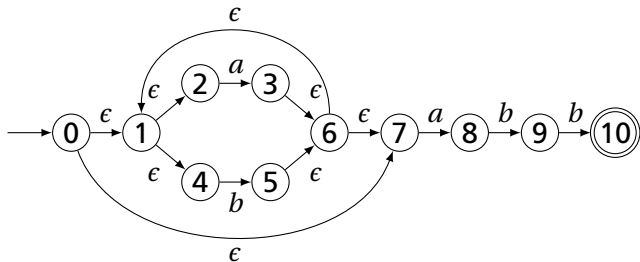

Show that the string "aabb" is accepted. Answer:

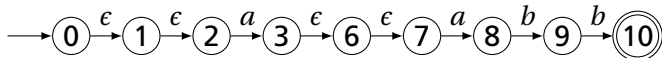

Simulating NFAs

Problem: you must follow the “right” arcs to show that a string is accepted. How do you know which arc is right?

Solution: follow them all and sort it out later.

“Two-stack” NFA simulation algorithm:

1. Initial states: the ϵ -closure of the start state
2. For each character c ,
 - ▶ New states: follow all transitions labeled c
 - ▶ Form the ϵ -closure of the current states
3. Accept if any final state is accepting

Simulating an NFA: $\cdot aabb$, Start

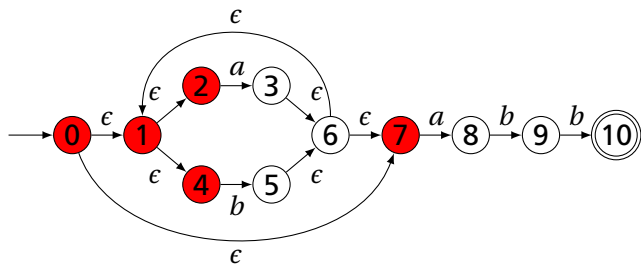
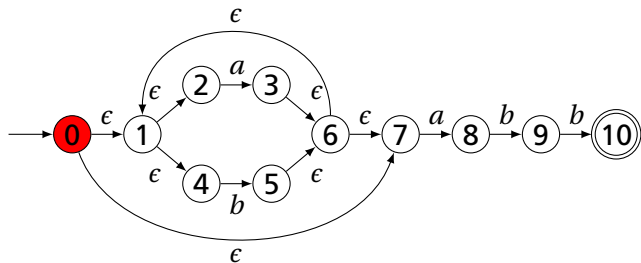

Simulating an NFA: $a \cdot abb$

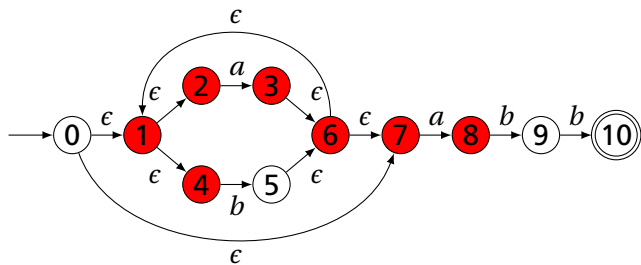
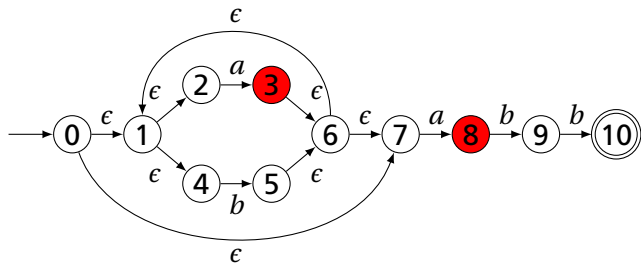

Simulating an NFA: $aa \cdot bb$

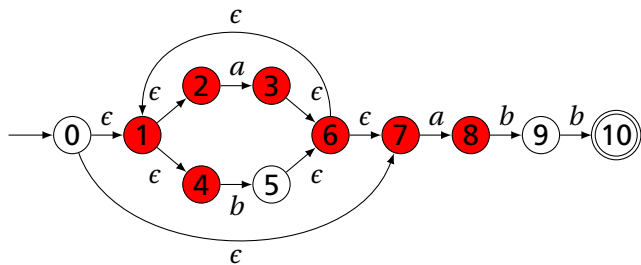
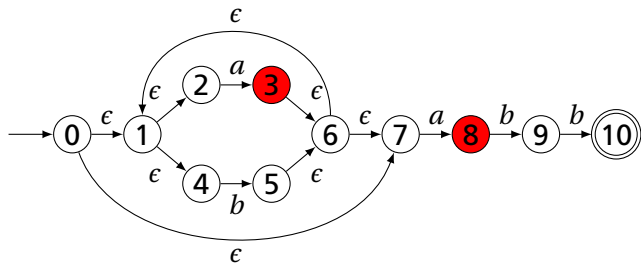

Simulating an NFA: $aab \cdot b$

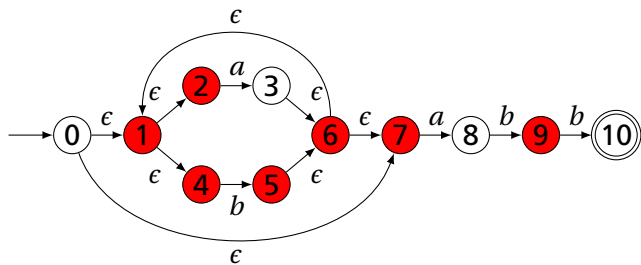
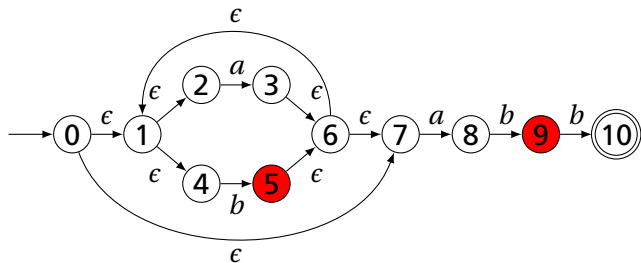

Simulating an NFA: *aabb*., Done

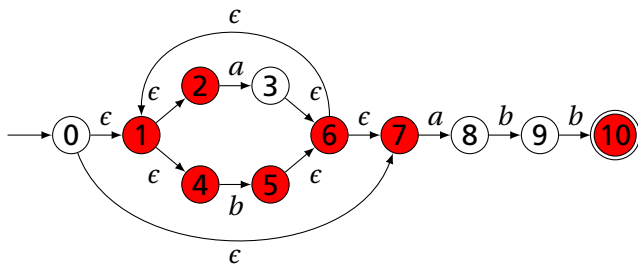
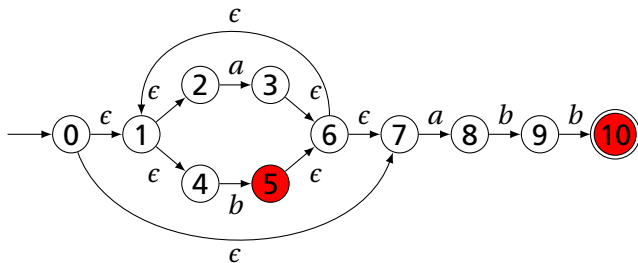

Deterministic Finite Automata

Restricted form of NFAs:

- ▶ No state has a transition on ϵ
- ▶ For each state s and symbol a , there is at most one edge labeled a leaving s .

Differs subtly from the definition used in COMS W3261
(Sipser, *Introduction to the Theory of Computation*)

Very easy to check acceptance: simulate by maintaining current state. Accept if you end up on an accepting state. Reject if you end on a non-accepting state or if there is no transition from the current state for the next symbol.

Deterministic Finite Automata

```
{  
  type token = ELSE | ELSEIF  
}
```

```
rule token =  
  parse "else"  { ELSE }  
  | "elseif" { ELSEIF }
```

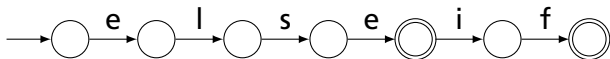

Deterministic Finite Automata

```
{ type token = IF | ID of string | NUM of string }
```

```
rule token =
```

```
  parse "if"
```

```
    | ['a'-'z'] ['a'-'z' '0'-'9']* as lit { ID(lit) }
```

```
    | ['0'-'9']+ as num { NUM(num) }
```

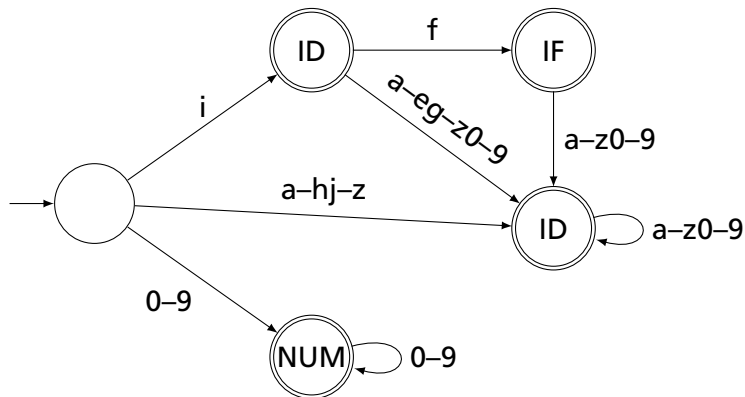

Building a DFA from an NFA

Subset construction algorithm

Simulate the NFA for all possible inputs and track the states that appear.

Each unique state during simulation becomes a state in the DFA.

Subset construction for $(a | b)^* abb$

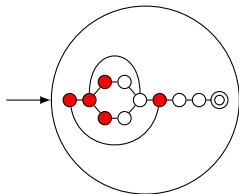

Subset construction for $(a|b)^*abb$

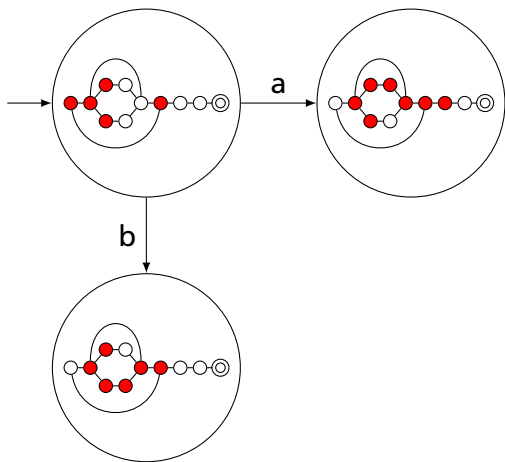

Subset construction for $(a|b)^*abb$

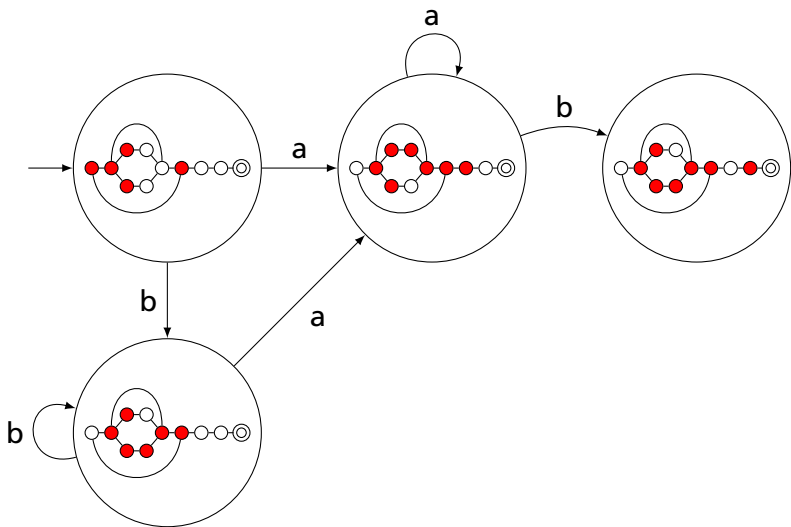

Subset construction for $(a|b)^*abb$

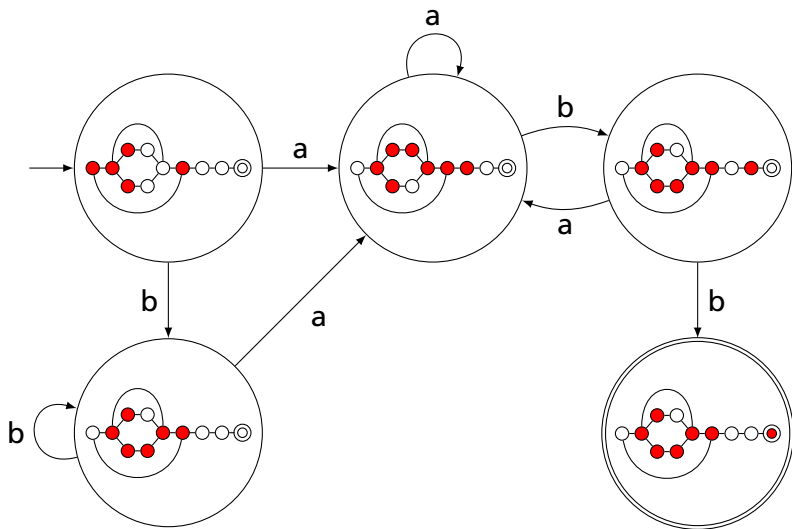

Subset construction for $(a|b)^*abb$

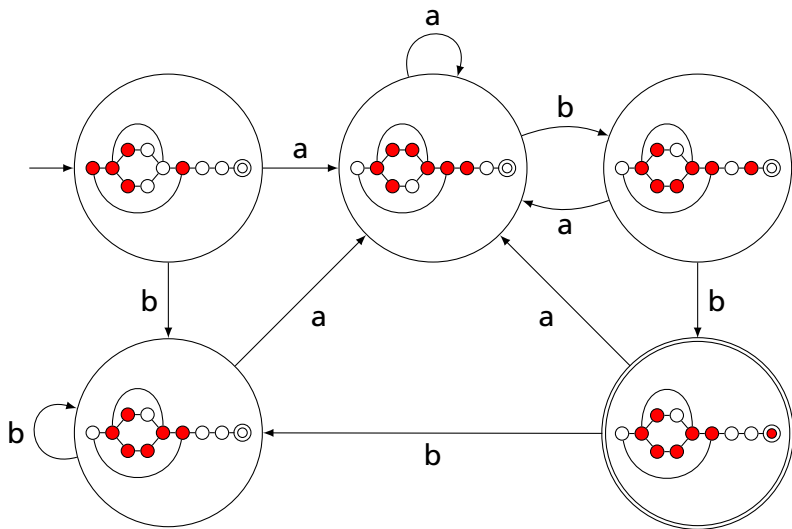

Result of subset construction for $(a | b)^* abb$

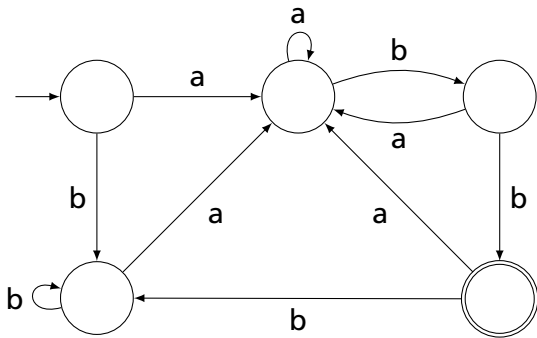

Ambiguous Arithmetic

Ambiguity can be a problem in expressions. Consider parsing

$$3 - 4 * 2 + 5$$

with the grammar

$$e \rightarrow e + e \mid e - e \mid e * e \mid e / e \mid N$$

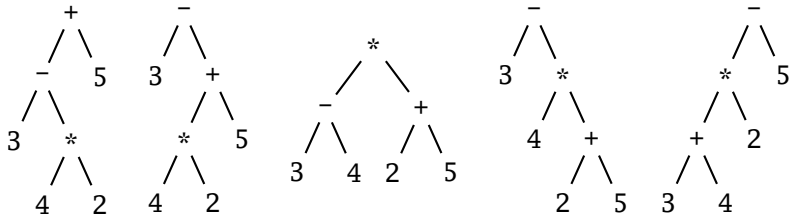

Operator Precedence

Defines how "sticky" an operator is.

$$1 * 2 + 3 * 4$$

* at higher precedence than +:

$$(1 * 2) + (3 * 4)$$

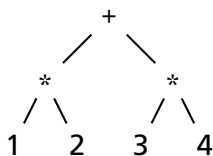

+ at higher precedence than *:

$$1 * (2 + 3) * 4$$

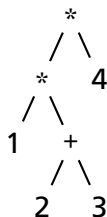

Associativity

Whether to evaluate left-to-right or right-to-left

Most operators are left-associative

$$1 - 2 - 3 - 4$$

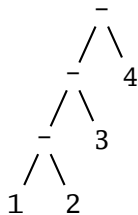

$$((1 - 2) - 3) - 4$$

left associative

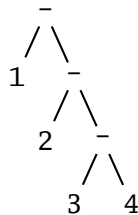

$$1 - (2 - (3 - 4))$$

right associative

Fixing Ambiguous Grammars

A grammar specification:

```
expr :  
    expr PLUS expr  
    | expr MINUS expr  
    | expr TIMES expr  
    | expr DIVIDE expr  
    | NUMBER
```

Ambiguous: no precedence or associativity.

Ocamlyacc's complaint: "16 shift/reduce conflicts."

Assigning Precedence Levels

Split into multiple rules, one per level

```
expr : expr PLUS expr  
      | expr MINUS expr  
      | term  
  
term : term TIMES term  
      | term DIVIDE term  
      | atom  
  
atom : NUMBER
```

Still ambiguous: associativity not defined

Ocamlyacc's complaint: "8 shift/reduce conflicts."

Assigning Associativity

Make one side the next level of precedence

```
expr : expr PLUS term  
      | expr MINUS term  
      | term  
  
term : term TIMES atom  
      | term DIVIDE atom  
      | atom  
  
atom : NUMBER
```

This is left-associative.

No shift/reduce conflicts.

Rightmost Derivation of $\text{Id} * \text{Id} + \text{Id}$

1: $e \rightarrow t + e$

2: $e \rightarrow t$

3: $t \rightarrow \text{Id} * t$

4: $t \rightarrow \text{Id}$

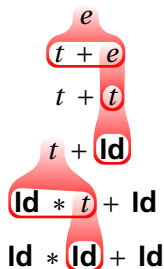

At each step, expand the *rightmost* nonterminal.

nonterminal

“handle”: The right side of a production

Fun and interesting fact: there is exactly one rightmost expansion if the grammar is unambiguous.

Rightmost Derivation: What to Expand

1: $e \rightarrow t + e$

2: $e \rightarrow t$

3: $t \rightarrow \mathbf{Id} * t$

4: $t \rightarrow \mathbf{Id}$

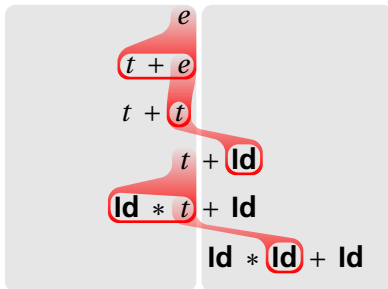
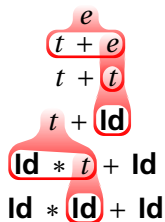

Expand here ↑ Terminals only

Reverse Rightmost Derivation

1: $e \rightarrow t + e$

2: $e \rightarrow t$

3: $t \rightarrow \text{Id} * t$

4: $t \rightarrow \text{Id}$

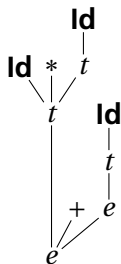
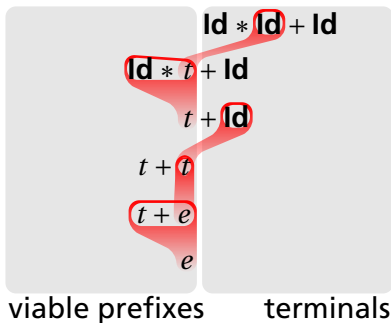
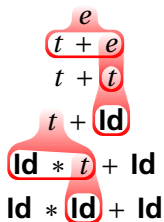

Shift/Reduce Parsing Using an Oracle

1: $e \rightarrow t + e$

2: $e \rightarrow t$

3: $t \rightarrow \text{Id} * t$

4: $t \rightarrow \text{Id}$

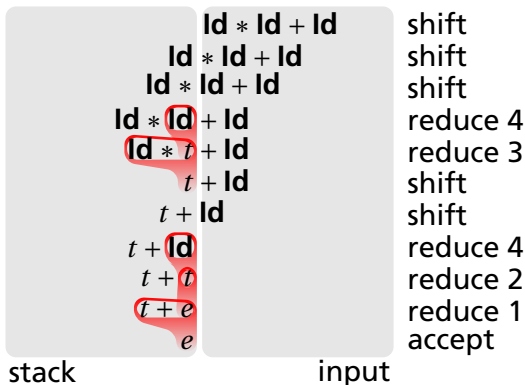
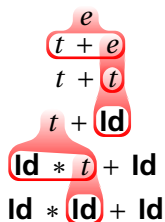

Handle Hunting

Right Sentential Form: any step in a rightmost derivation

Handle: in a sentential form, a RHS of a rule that, when rewritten, yields the previous step in a rightmost derivation.

The big question in shift/reduce parsing:

When is there a handle on the top of the stack?

Enumerate all the right-sentential forms and pattern-match against them? *Usually infinite in number, but let's try anyway.*

The Handle-Identifying Automaton

Magical result, due to Knuth: *An automaton suffices to locate a handle in a right-sentential form.*

$\text{Id} * \text{Id} * \dots * \text{Id} * t \dots$
 $\text{Id} * \text{Id} * \dots * \text{Id} \dots$
 $t + t + \dots + t + e$
 $t + t + \dots + t + \text{Id}$
 $t + t + \dots + t + \text{Id} * \text{Id} * \dots * \text{Id} * t$
 $t + t + \dots + t$

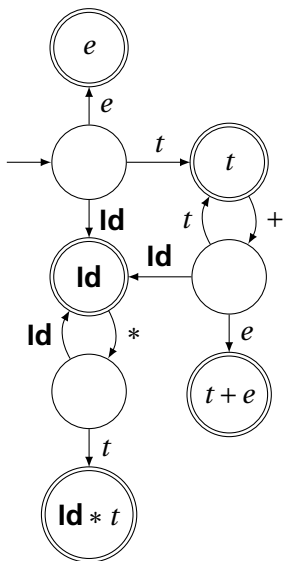

Building the Initial State of the LR(0) Automaton

$$e' \rightarrow \cdot e$$

1: $e \rightarrow t + e$

2: $e \rightarrow t$

3: $t \rightarrow \mathbf{ld} * t$

4: $t \rightarrow \mathbf{ld}$

Key idea: automata identify viable prefixes of right sentential forms. Each state is an equivalence class of possible places in productions.

At the beginning, any viable prefix must be at the beginning of a string expanded from e . We write this condition " $e' \rightarrow \cdot e$ "

Building the Initial State of the LR(0) Automaton

1: $e \rightarrow t + e$

2: $e \rightarrow t$

3: $t \rightarrow \mathbf{ld} * t$

4: $t \rightarrow \mathbf{ld}$

$$e' \rightarrow \cdot e$$
$$e \rightarrow \cdot t + e$$
$$e \rightarrow \cdot t$$

Key idea: automata identify viable prefixes of right sentential forms. Each state is an equivalence class of possible places in productions.

At the beginning, any viable prefix must be at the beginning of a string expanded from e . We write this condition " $e' \rightarrow \cdot e$ "

There are two choices for what an e may expand to: $t + e$ and t . So when $e' \rightarrow \cdot e$, $e \rightarrow \cdot t + e$ and $e \rightarrow \cdot t$ are also true, i.e., it must start with a string expanded from t .

Building the Initial State of the LR(0) Automaton

1: $e \rightarrow t + e$

2: $e \rightarrow t$

3: $t \rightarrow \mathbf{ld} * t$

4: $t \rightarrow \mathbf{ld}$

$$e' \rightarrow \cdot e$$
$$e \rightarrow \cdot t + e$$
$$e \rightarrow \cdot t$$
$$t \rightarrow \cdot \mathbf{ld} * t$$
$$t \rightarrow \cdot \mathbf{ld}$$

Key idea: automata identify viable prefixes of right sentential forms. Each state is an equivalence class of possible places in productions.

At the beginning, any viable prefix must be at the beginning of a string expanded from e . We write this condition " $e' \rightarrow \cdot e$ "

There are two choices for what an e may expand to: $t + e$ and t . So when $e' \rightarrow \cdot e$, $e \rightarrow \cdot t + e$ and $e \rightarrow \cdot t$ are also true, i.e., it must start with a string expanded from t .

Similarly, t must be either $\mathbf{ld} * t$ or \mathbf{ld} , so $t \rightarrow \cdot \mathbf{ld} * t$ and $t \rightarrow \cdot \mathbf{ld}$.

Building the LR(0) Automaton

$$e' \rightarrow \cdot e$$
$$e \rightarrow \cdot t + e$$

S0: $e \rightarrow \cdot t$

$$t \rightarrow \cdot \mathbf{ld} * t$$
$$t \rightarrow \cdot \mathbf{ld}$$

The first state suggests a viable prefix can start as any string derived from e , any string derived from t , or \mathbf{ld} .

Building the LR(0) Automaton

*"Just passed a string
derived from e "*

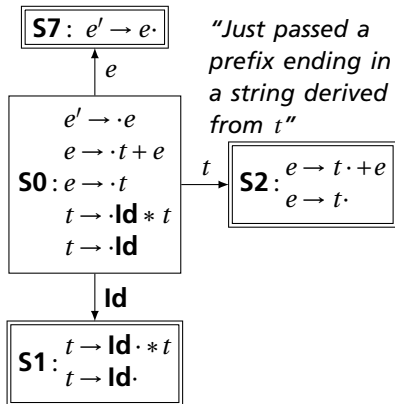

*"Just passed a
prefix ending in
a string derived
from t "*

The first state suggests a viable prefix can start as any string derived from e , any string derived from t , or ld .

The items for these three states come from advancing the \cdot across each thing, then performing the closure operation (vacuous here).

*"Just passed a
prefix that ended
in an ld "*

Building the LR(0) Automaton

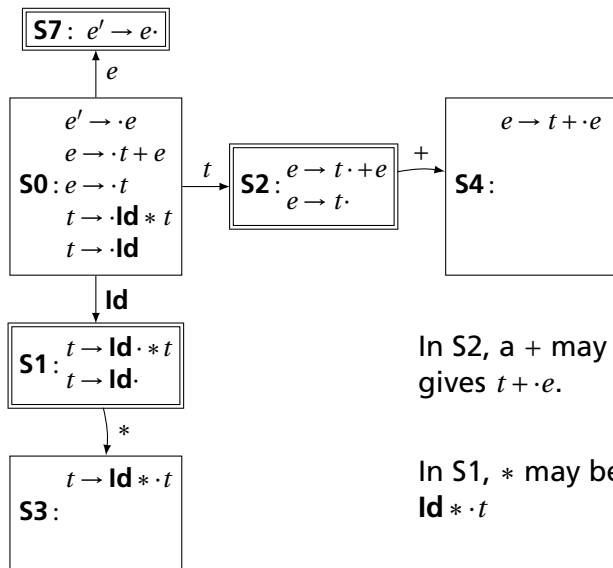

In S2, a $+$ may be next. This gives $t + \cdot e$.

In S1, $*$ may be next, giving $\text{ld} * \cdot t$

Building the LR(0) Automaton

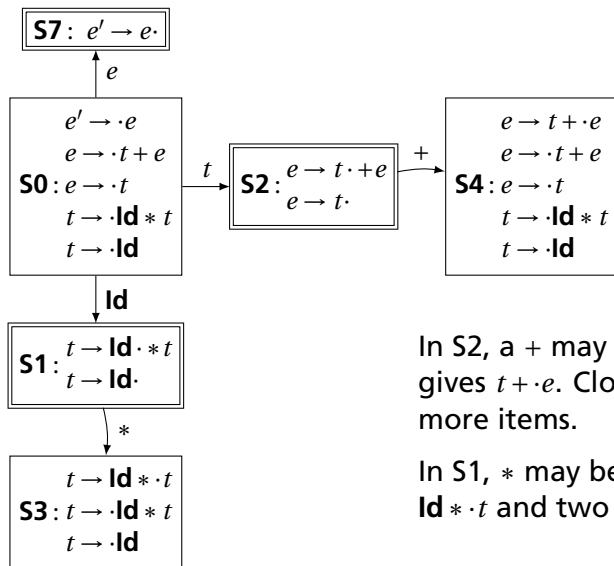

In S2, a + may be next. This gives $t + \cdot e$. Closure adds 4 more items.

In S1, * may be next, giving $\text{ld} * \cdot t$ and two others.

Building the LR(0) Automaton

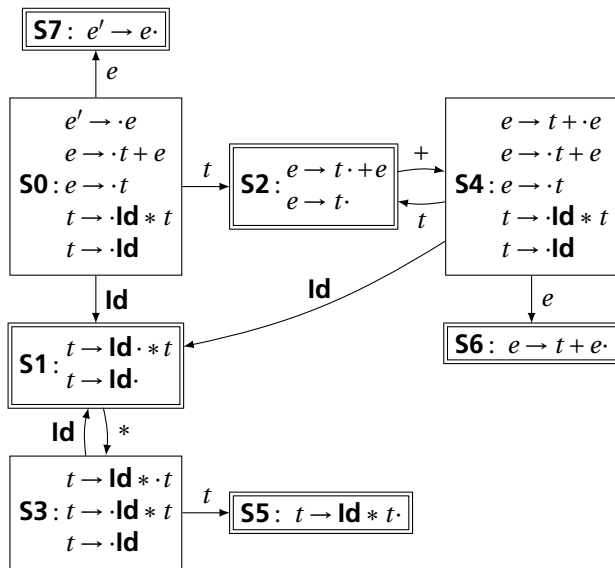

The first function

If you can derive a string that starts with terminal t from a sequence of terminals and nonterminals α , then $t \in \text{first}(\alpha)$.

1. If X is a terminal, $\text{first}(X) = \{X\}$.
2. If $X \rightarrow \epsilon$, then add ϵ to $\text{first}(X)$.
3. If $X \rightarrow Y_1 \cdots Y_k$ and $\epsilon \in \text{first}(Y_1)$, $\epsilon \in \text{first}(Y_2)$, \dots , and $\epsilon \in \text{first}(Y_{i-1})$ for $i = 1, \dots, k$ for some k ,
add $\text{first}(Y_i) - \{\epsilon\}$ to $\text{first}(X)$

X starts with anything that appears after skipping empty strings. Usually just $\text{first}(Y_1) \in \text{first}(X)$

4. If $X \rightarrow Y_1 \cdots Y_k$ and $\epsilon \in \text{first}(Y_1)$, $\epsilon \in \text{first}(Y_2)$, \dots , and $\epsilon \in \text{first}(Y_k)$, add ϵ to $\text{first}(X)$

If all of X can be empty, X can be empty

1: $e \rightarrow t + e$

$\text{first}(\mathbf{Id}) = \{\mathbf{Id}\}$

2: $e \rightarrow t$

$\text{first}(t) = \{\mathbf{Id}\}$ because $t \rightarrow \mathbf{Id} * t$ and $t \rightarrow \mathbf{Id}$

3: $t \rightarrow \mathbf{Id} * t$

$\text{first}(e) = \{\mathbf{Id}\}$ because $e \rightarrow t + e$, $e \rightarrow t$, and

4: $t \rightarrow \mathbf{Id}$

$\text{first}(t) = \{\mathbf{Id}\}$.

First and ϵ

$\epsilon \in \text{first}(\alpha)$ means α can derive the empty string.

1. If X is a terminal, $\text{first}(X) = \{X\}$.
2. If $X \rightarrow \epsilon$, then add ϵ to $\text{first}(X)$.
3. If $X \rightarrow Y_1 \cdots Y_k$ and
 $\epsilon \in \text{first}(Y_1)$, $\epsilon \in \text{first}(Y_2)$, \dots , and $\epsilon \in \text{first}(Y_{i-1})$
for $i = 1, \dots, k$ for some k ,
add $\text{first}(Y_i) - \{\epsilon\}$ to $\text{first}(X)$
4. If $X \rightarrow Y_1 \cdots Y_K$ and
 $\epsilon \in \text{first}(Y_1)$, $\epsilon \in \text{first}(Y_2)$, \dots , and $\epsilon \in \text{first}(Y_k)$,
add ϵ to $\text{first}(X)$

$X \rightarrow YZa$	$\text{first}(b) = \{b\}$ $\text{first}(c) = \{c\}$ $\text{first}(d) = \{d\}$	(1)
$Y \rightarrow$	$\text{first}(W) = \{\epsilon\} \cup \text{first}(d) = \{\epsilon, d\}$	(2, 3)
$Y \rightarrow b$	$\text{first}(Z) = \text{first}(c) \cup (\text{first}(W) - \{\epsilon\}) \cup \{\epsilon\} = \{\epsilon, c, d\}$	(3, 3, 4)
$Z \rightarrow c$	$\text{first}(Y) = \{\epsilon\} \cup \{b\} = \{\epsilon, b\}$	(2, 3)
$Z \rightarrow W$	$\text{first}(X) = (\text{first}(Y) - \{\epsilon\}) \cup (\text{first}(Z) - \{\epsilon\}) \cup$	
$W \rightarrow$	$\text{first}(a) = \{a, b, c, d\}$	(3, 3, 3)
$W \rightarrow d$		

The follow function

If t is a terminal, A is a nonterminal, and $\dots At\dots$ can be derived, then $t \in \text{follow}(A)$.

1. Add \$ ("end-of-input") to $\text{follow}(S)$ (start symbol).
End-of-input comes after the start symbol
2. For each prod. $\rightarrow \dots A\alpha$, add $\text{first}(\alpha) - \{\epsilon\}$ to $\text{follow}(A)$.
A is followed by the first thing after it
3. For each prod. $A \rightarrow \dots B$ or $A \rightarrow \dots B\alpha$ where $\epsilon \in \text{first}(\alpha)$, then add everything in $\text{follow}(A)$ to $\text{follow}(B)$.
If B appears at the end of a production, it can be followed by whatever follows that production

1: $e \rightarrow t + e$

$\text{follow}(e) = \{\$\}$

2: $e \rightarrow t$

$\text{follow}(t) = \{ \quad \}$

3: $t \rightarrow \mathbf{ld} * t$

1. Because e is the start symbol

4: $t \rightarrow \mathbf{ld}$

$\text{first}(t) = \{\mathbf{ld}\}$

$\text{first}(e) = \{\mathbf{ld}\}$

The follow function

If t is a terminal, A is a nonterminal, and $\dots At\dots$ can be derived, then $t \in \text{follow}(A)$.

1. Add \$ ("end-of-input") to $\text{follow}(S)$ (start symbol).
End-of-input comes after the start symbol
2. For each prod. $\rightarrow \dots A\alpha$, add $\text{first}(\alpha) - \{\epsilon\}$ to $\text{follow}(A)$.
A is followed by the first thing after it
3. For each prod. $A \rightarrow \dots B$ or $A \rightarrow \dots B\alpha$ where $\epsilon \in \text{first}(\alpha)$, then add everything in $\text{follow}(A)$ to $\text{follow}(B)$.
If B appears at the end of a production, it can be followed by whatever follows that production

1: $e \rightarrow t + e$

$\text{follow}(e) = \{\$\}$

2: $e \rightarrow t$

$\text{follow}(t) = \{+ \}$

3: $t \rightarrow \mathbf{ld} * t$

2. Because $e \rightarrow \underline{t} + e$ and $\text{first}(+) = \{+\}$

4: $t \rightarrow \mathbf{ld}$

$\text{first}(t) = \{\mathbf{ld}\}$

$\text{first}(e) = \{\mathbf{ld}\}$

The follow function

If t is a terminal, A is a nonterminal, and $\dots At\dots$ can be derived, then $t \in \text{follow}(A)$.

1. Add \$ ("end-of-input") to $\text{follow}(S)$ (start symbol).
End-of-input comes after the start symbol
2. For each prod. $\rightarrow \dots A\alpha$, add $\text{first}(\alpha) - \{\epsilon\}$ to $\text{follow}(A)$.
A is followed by the first thing after it
3. For each prod. $A \rightarrow \dots B$ or $A \rightarrow \dots B\alpha$ where $\epsilon \in \text{first}(\alpha)$, then add everything in $\text{follow}(A)$ to $\text{follow}(B)$.
If B appears at the end of a production, it can be followed by whatever follows that production

1: $e \rightarrow t + e$

$\text{follow}(e) = \{\$\}$

2: $e \rightarrow t$

$\text{follow}(t) = \{+, \$\}$

3: $t \rightarrow \mathbf{ld} * t$

3. Because $e \rightarrow \underline{t}$ and $\$ \in \text{follow}(e)$

4: $t \rightarrow \mathbf{ld}$

$\text{first}(t) = \{\mathbf{ld}\}$

$\text{first}(e) = \{\mathbf{ld}\}$

The follow function

If t is a terminal, A is a nonterminal, and $\dots At\dots$ can be derived, then $t \in \text{follow}(A)$.

1. Add \$ ("end-of-input") to $\text{follow}(S)$ (start symbol).
End-of-input comes after the start symbol
2. For each prod. $\rightarrow \dots A\alpha$, add $\text{first}(\alpha) - \{\epsilon\}$ to $\text{follow}(A)$.
A is followed by the first thing after it
3. For each prod. $A \rightarrow \dots B$ or $A \rightarrow \dots B\alpha$ where $\epsilon \in \text{first}(\alpha)$, then add everything in $\text{follow}(A)$ to $\text{follow}(B)$.
If B appears at the end of a production, it can be followed by whatever follows that production

1: $e \rightarrow t + e$

$\text{follow}(e) = \{\$\}$

2: $e \rightarrow t$

$\text{follow}(t) = \{+, \$\}$

3: $t \rightarrow \mathbf{ld} * t$

4: $t \rightarrow \mathbf{ld}$

$\text{first}(t) = \{\mathbf{ld}\}$

Fixed-point reached: applying any rule does not change any set

$\text{first}(e) = \{\mathbf{ld}\}$

Converting the LR(0) Automaton to an SLR Parsing Table

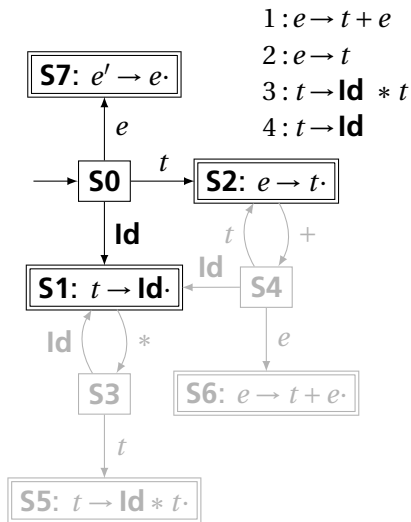

State	Action				Goto	
	Id	+	*	\$	e	t
0	s1				7	2

From S0, shift an **Id** and go to S1; or cross a **t** and go to S2; or cross an **e** and go to S7.

Converting the LR(0) Automaton to an SLR Parsing Table

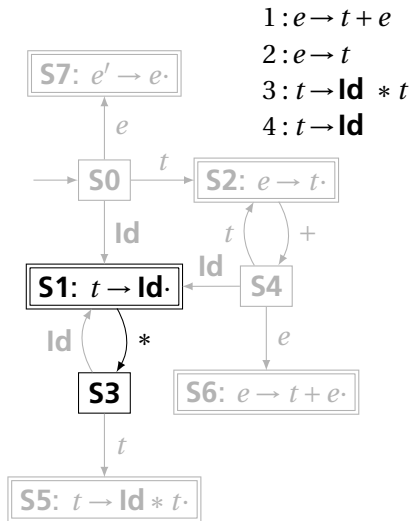

State	Action				Goto	
	Id	+	*	\$	e	t
0	s1				7	2
1		r4	s3	r4		

From S1, shift a $*$ and go to S3; or, if the next input could follow a t , reduce by rule 4. According to rule 1, $+$ could follow t ; from rule 2, $\$$ could.

Converting the LR(0) Automaton to an SLR Parsing Table

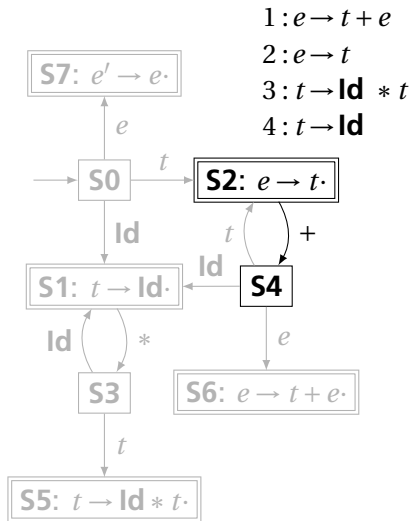

State	Action				Goto	
	Id	+	*	\$	e	t
0	s1				7	2
1		r4	s3	r4		
2		s4		r2		

From S2, shift a + and go to S4; or, if the next input could follow an e (only the end-of-input \$), reduce by rule 2.

Converting the LR(0) Automaton to an SLR Parsing Table

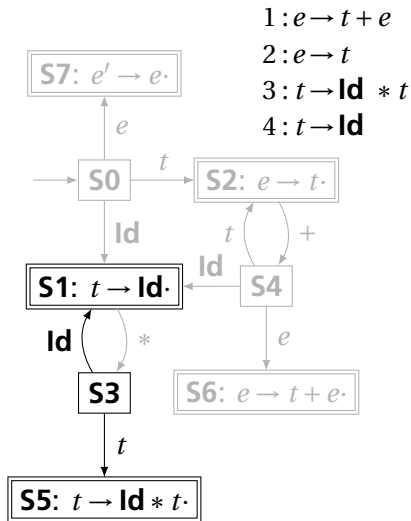

State	Action				Goto	
	Id	+	*	\$	e	t
0	s1				7	2
1		r4	s3	r4		
2		s4		r2		
3	s1					5

From S3, shift an **Id** and go to S1;
 or cross a t and go to S5.

Converting the LR(0) Automaton to an SLR Parsing Table

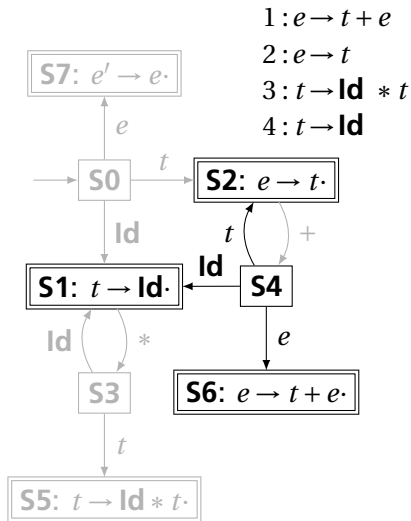

State	Action				Goto	
	Id	+	*	\$	e	t
0	s1				7	2
1		r4	s3	r4		
2		s4		r2		
3	s1					5
4	s1				6	2

From S4, shift an **Id** and go to S1;
 or cross an e or a t .

Converting the LR(0) Automaton to an SLR Parsing Table

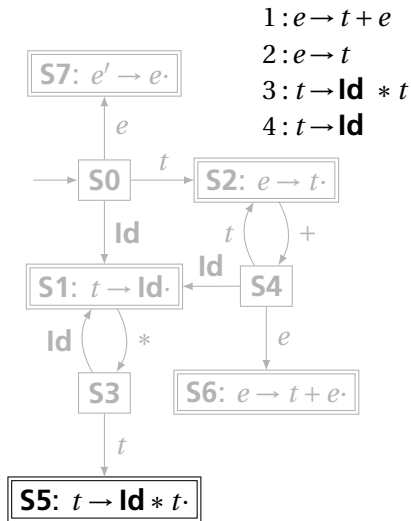

State	Action				Goto	
	Id	+	*	\$	e	t
0	s1				7	2
1		r4	s3	r4		
2		s4		r2		
3	s1					5
4	s1				6	2
5		r3		r3		

From S5, reduce using rule 3 if the next symbol could follow a t (again, + and \$).

Converting the LR(0) Automaton to an SLR Parsing Table

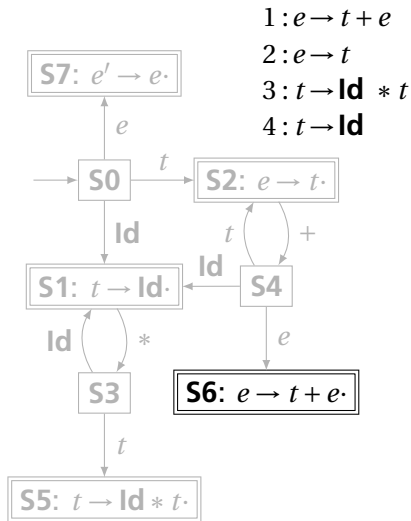

State	Action				Goto	
	Id	+	*	\$	e	t
0	s1				7	2
1		r4	s3	r4		
2		s4		r2		
3	s1					5
4	s1				6	2
5		r3		r3		
6				r1		

From S6, reduce using rule 1 if the next symbol could follow an e (\$ only).

Converting the LR(0) Automaton to an SLR Parsing Table

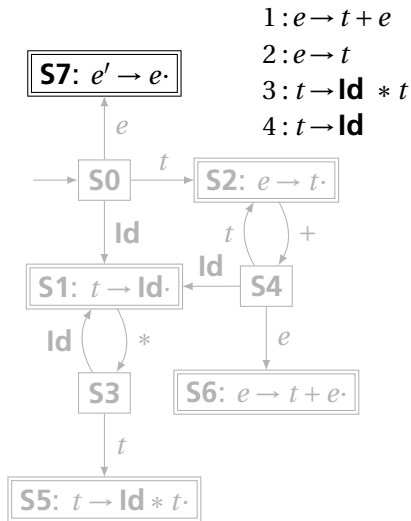

State	Action				Goto	
	Id	+	*	\$	e	t
0	s1				7	2
1		r4	s3	r4		
2		s4		r2		
3	s1					5
4	s1				6	2
5		r3		r3		
6				r1		
7				✓		

If, in S7, we just crossed an e , accept if we are at the end of the input.

Shift/Reduce Parsing with an SLR Table

1: $e \rightarrow t + e$

2: $e \rightarrow t$

3: $t \rightarrow \mathbf{Id} * t$

4: $t \rightarrow \mathbf{Id}$

State	Action				Goto	
	Id	+	*	\$	e	t
0	s1				7	2
1		r4	s3	r4		
2		s4		r2		
3	s1					5
4	s1				6	2
5		r3		r3		
6				r1		
7				✓		

Stack	Input	Action
0	Id * Id + Id \$	Shift, goto 1

Look at the state on top of the stack and the next input token.

Find the action (shift, reduce, or error) in the table.

In this case, shift the token onto the stack and mark it with state 1.

Shift/Reduce Parsing with an SLR Table

1: $e \rightarrow t + e$

2: $e \rightarrow t$

3: $t \rightarrow \mathbf{Id} * t$

4: $t \rightarrow \mathbf{Id}$

Stack	Input	Action
0	Id * Id + Id \$	Shift, goto 1
0 Id 1	* Id + Id \$	Shift, goto 3

Here, the state is 1, the next symbol is *, so shift and mark it with state 3.

State	Action				Goto	
	Id	+	*	\$	e	t
0	s1				7	2
1		r4	s3	r4		
2		s4		r2		
3	s1					5
4	s1				6	2
5		r3		r3		
6				r1		
7				✓		

Shift/Reduce Parsing with an SLR Table

1: $e \rightarrow t + e$

2: $e \rightarrow t$

3: $t \rightarrow \text{Id} * t$

4: $t \rightarrow \text{Id}$

State	Action				Goto	
	Id	+	*	\$	e	t
0	s1				7	2
1		r4	s3	r4		
2		s4		r2		
3	s1					5
4	s1				6	2
5		r3		r3		
6				r1		
7				✓		

Stack	Input	Action
0	Id * Id + Id \$	Shift, goto 1
0 Id	* Id + Id \$	Shift, goto 3
0 Id *	Id + Id \$	Shift, goto 1
0 Id * Id	+ Id \$	Reduce 4

Here, the state is 1, the next symbol is +. The table says reduce using rule 4.

Shift/Reduce Parsing with an SLR Table

1: $e \rightarrow t + e$

2: $e \rightarrow t$

3: $t \rightarrow \mathbf{Id} * t$

4: $t \rightarrow \mathbf{Id}$

State	Action				Goto	
	Id	+	*	\$	e	t
0	s1				7	2
1		r4	s3	r4		
2		s4		r2		
3	s1					5
4	s1				6	2
5		r3		r3		
6				r1		
7				✓		

Stack	Input	Action
0	Id * Id + Id \$	Shift, goto 1
0 Id	* Id + Id \$	Shift, goto 3
0 Id *	Id + Id \$	Shift, goto 1
0 Id * Id	+ Id \$	Reduce 4
0 Id *	+ Id \$	

Remove the RHS of the rule (here, just **Id**), observe the state on the top of the stack, and consult the "goto" portion of the table.

Shift/Reduce Parsing with an SLR Table

- 1: $e \rightarrow t + e$
- 2: $e \rightarrow t$
- 3: $t \rightarrow \text{Id} * t$
- 4: $t \rightarrow \text{Id}$

State	Action				Goto	
	Id	+	*	\$	<i>e</i>	<i>t</i>
0	s1				7	2
1		r4	s3	r4		
2		s4		r2		
3	s1					5
4	s1				6	2
5		r3		r3		
6				r1		
7				✓		

Stack	Input	Action
0	Id * Id + Id \$	Shift, goto 1
0 Id	* Id + Id \$	Shift, goto 3
0 Id *	Id + Id \$	Shift, goto 1
0 Id * Id	+ Id \$	Reduce 4
0 Id * Id	+ Id \$	Reduce 3

Here, we push a *t* with state 5. This effectively “backs up” the LR(0) automaton and runs it over the newly added nonterminal.

In state 5 with an upcoming +, the action is “reduce 3.”

Shift/Reduce Parsing with an SLR Table

1: $e \rightarrow t + e$

2: $e \rightarrow t$

3: $t \rightarrow \mathbf{Id} * t$

4: $t \rightarrow \mathbf{Id}$

State	Action				Goto	
	Id	+	*	\$	<i>e</i>	<i>t</i>
0	s1				7	2
1		r4	s3	r4		
2		s4		r2		
3	s1					5
4	s1				6	2
5		r3		r3		
6				r1		
7				✓		

Stack	Input	Action
0	Id * Id + Id \$	Shift, goto 1
0 Id	* Id + Id \$	Shift, goto 3
0 Id *	Id + Id \$	Shift, goto 1
0 Id * Id	+ Id \$	Reduce 4
0 Id * Id	+ Id \$	Reduce 3
0 t	+ Id \$	Shift, goto 4

This time, we strip off the RHS for rule 3, $\mathbf{Id} * t$, exposing state 0, so we push a t with state 2.

Shift/Reduce Parsing with an SLR Table

1: $e \rightarrow t + e$

2: $e \rightarrow t$

3: $t \rightarrow \mathbf{Id} * t$

4: $t \rightarrow \mathbf{Id}$

State	Action				Goto	
	Id	+	*	\$	e	t
0	s1				7	2
1		r4	s3	r4		
2		s4		r2		
3	s1					5
4	s1				6	2
5		r3		r3		
6				r1		
7				✓		

Stack	Input	Action
0	Id * Id + Id \$	Shift, goto 1
0 Id	* Id + Id \$	Shift, goto 3
0 Id *	Id + Id \$	Shift, goto 1
0 Id * Id	+ Id \$	Reduce 4
0 Id * Id *	+ Id \$	Reduce 3
0 Id * Id *	+ Id \$	Shift, goto 4
0 Id * Id *	Id \$	Shift, goto 1
0 Id * Id *	\$	Reduce 4
0 Id * Id *	\$	Reduce 2
0 Id * Id *	\$	Reduce 1
0 Id * Id *	\$	Accept

Applicative- and Normal-Order Evaluation

```
int p(int i) {  
    printf("%d ", i);  
    return i;  
}  
  
void q(int a, int b, int c)  
{  
    int total = a;  
    printf("%d ", b);  
    total += c;  
}  
  
q( p(1), 2, p(3) );
```

What does this print?

Applicative- vs. and Normal-Order

Most languages use applicative order.

Macro-like languages often use normal order.

```
#define p(x) (printf("%d ",x), x)

#define q(a,b,c) total = (a), \
    printf("%d ", (b)), \
    total += (c)

q( p(1), 2, p(3) );
```

Prints 1 2 3.

Some functional languages also use normal order evaluation to avoid doing work. "Lazy Evaluation"

Storage Classes and Memory Layout

Stack: objects created/destroyed in last-in, first-out order

Heap: objects created/destroyed in any order; automatic garbage collection optional

Static: objects allocated at compile time; persist throughout run

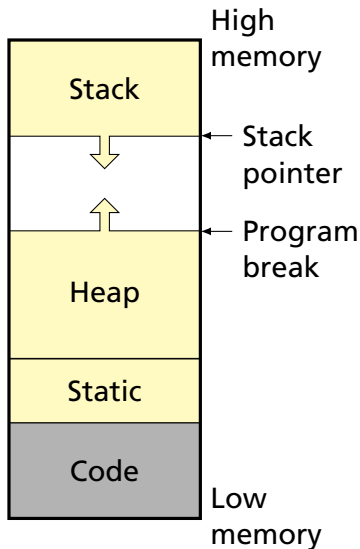

Static Objects

```
class Example {  
    public static final int a = 3;  
  
    public void hello() {  
        System.out.println("Hello");  
    }  
}
```

Advantages

Zero-cost memory management

Often faster access (address a constant)

No out-of-memory danger

Examples

Static class variable

Code for hello method

String constant "Hello"

Information about the Example class

Disadvantages

Size and number must be known beforehand

Wasteful if sharing is possible

Stack-Allocated Objects



Natural for supporting recursion.

Idea: some objects persist from when a procedure is called to when it returns.

Naturally implemented with a stack: linear array of memory that grows and shrinks at only one boundary.

Each invocation of a procedure gets its own *frame* (*activation record*) where it stores its own local variables and bookkeeping information.

An Activation Record: The State Before Calling *bar*

```
int foo(int a, int b) {  
    int c, d;  
    bar(1, 2, 3);  
}
```

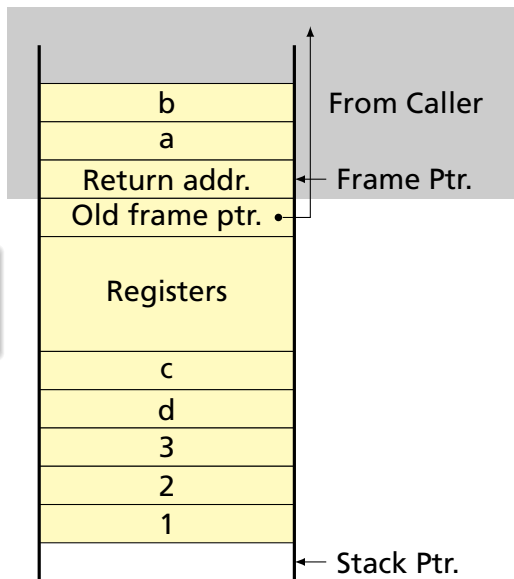

Recursive Fibonacci

(Real C)

```
int fib(int n) {  
    if (n<2)  
        return 1;  
    else  
        return  
            fib(n-1)  
            +  
            fib(n-2);  
}
```

(Assembly-like C)

```
int fib(int n) {  
    int tmp1, tmp2, tmp3;  
    tmp1 = n < 2;  
    if (!tmp1) goto L1;  
    return 1;  
L1: tmp1 = n - 1;  
    tmp2 = fib(tmp1);  
L2: tmp1 = n - 2;  
    tmp3 = fib(tmp1);  
L3: tmp1 = tmp2 + tmp3;  
    return tmp1;  
}
```

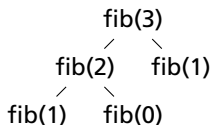

Executing fib(3)

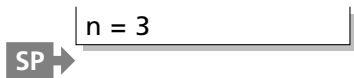

```
int fib(int n) {  
    int tmp1, tmp2, tmp3;  
    tmp1 = n < 2;  
    if (!tmp1) goto L1;  
    return 1;  
L1: tmp1 = n - 1;  
    tmp2 = fib(tmp1);  
L2: tmp1 = n - 2;  
    tmp3 = fib(tmp1);  
L3: tmp1 = tmp2 + tmp3;  
    return tmp1;  
}
```

Executing fib(3)

```
int fib(int n) {  
    int tmp1, tmp2, tmp3;  
    tmp1 = n < 2;  
    if (!tmp1) goto L1;  
    return 1;  
L1: tmp1 = n - 1;  
    tmp2 = fib(tmp1);  
L2: tmp1 = n - 2;  
    tmp3 = fib(tmp1);  
L3: tmp1 = tmp2 + tmp3;  
    return tmp1;  
}
```

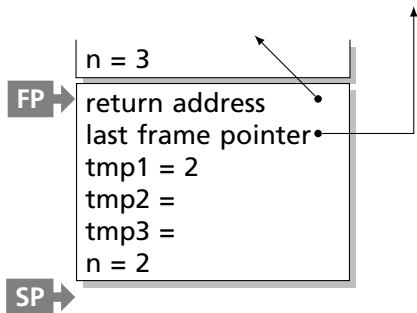

Executing fib(3)

```
int fib(int n) {  
    int tmp1, tmp2, tmp3;  
    tmp1 = n < 2;  
    if (!tmp1) goto L1;  
    return 1;  
L1: tmp1 = n - 1;  
    tmp2 = fib(tmp1);  
L2: tmp1 = n - 2;  
    tmp3 = fib(tmp1);  
L3: tmp1 = tmp2 + tmp3;  
    return tmp1;  
}
```

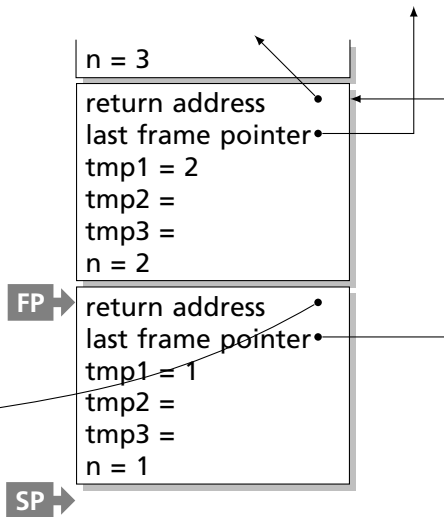

Executing fib(3)

```
int fib(int n) {  
    int tmp1, tmp2, tmp3;  
    tmp1 = n < 2;  
    if (!tmp1) goto L1;  
    return 1;  
L1: tmp1 = n - 1;  
    tmp2 = fib(tmp1);  
L2: tmp1 = n - 2;  
    tmp3 = fib(tmp1);  
L3: tmp1 = tmp2 + tmp3;  
    return tmp1;  
}
```

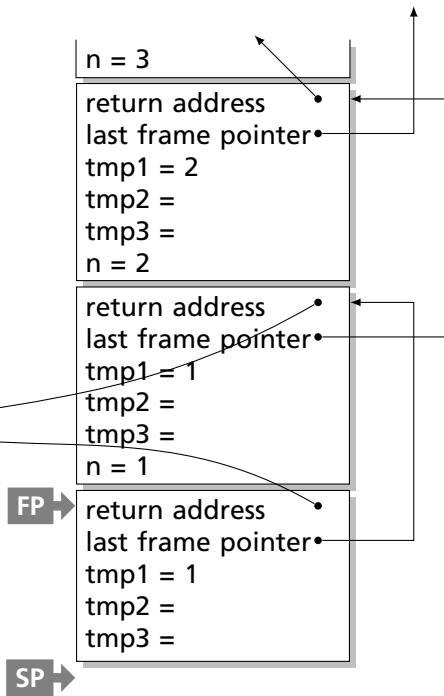

Executing fib(3)

```
int fib(int n) {  
    int tmp1, tmp2, tmp3;  
    tmp1 = n < 2;  
    if (!tmp1) goto L1;  
    return 1;  
L1: tmp1 = n - 1;  
    tmp2 = fib(tmp1);  
L2: tmp1 = n - 2;  
    tmp3 = fib(tmp1);  
L3: tmp1 = tmp2 + tmp3;  
    return tmp1;  
}
```

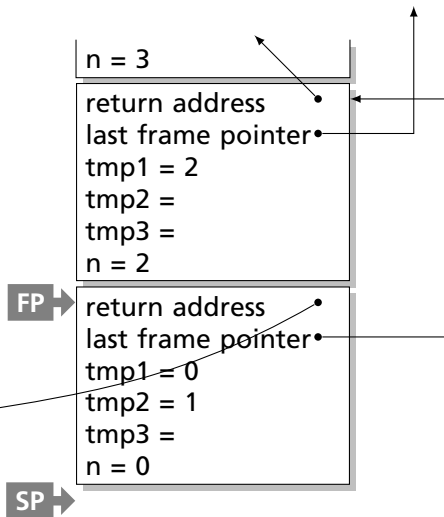

Executing fib(3)

```
int fib(int n) {  
    int tmp1, tmp2, tmp3;  
    tmp1 = n < 2;  
    if (!tmp1) goto L1;  
    return 1;  
L1: tmp1 = n - 1;  
    tmp2 = fib(tmp1);  
L2: tmp1 = n - 2;  
    tmp3 = fib(tmp1);  
L3: tmp1 = tmp2 + tmp3;  
    return tmp1;  
}
```

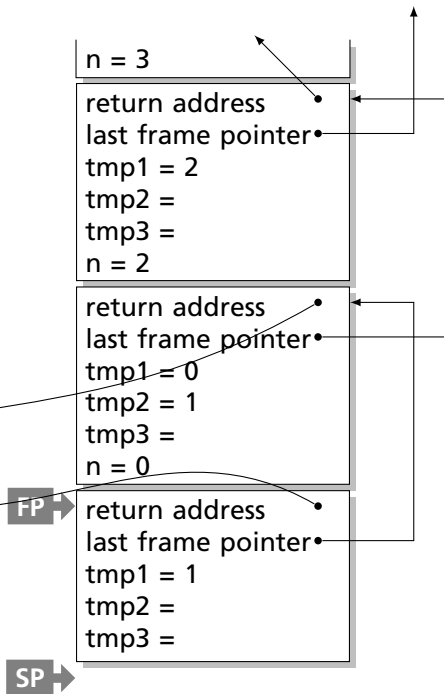

Executing fib(3)

```
int fib(int n) {  
    int tmp1, tmp2, tmp3;  
    tmp1 = n < 2;  
    if (!tmp1) goto L1;  
    return 1;  
L1: tmp1 = n - 1;  
    tmp2 = fib(tmp1);  
L2: tmp1 = n - 2;  
    tmp3 = fib(tmp1);  
L3: tmp1 = tmp2 + tmp3;  
    return tmp1;  
}
```

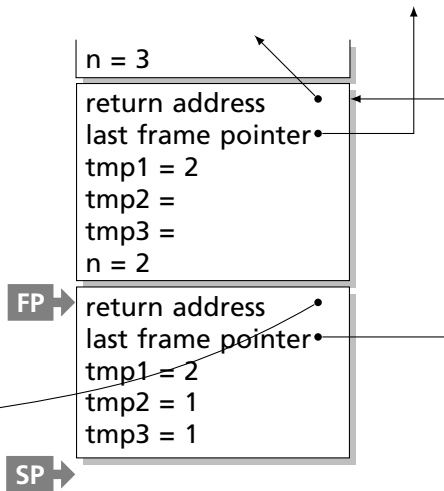

Executing fib(3)

```
int fib(int n) {  
    int tmp1, tmp2, tmp3;  
    tmp1 = n < 2;  
    if (!tmp1) goto L1;  
    return 1;  
L1: tmp1 = n - 1;  
    tmp2 = fib(tmp1);  
L2: tmp1 = n - 2;  
    tmp3 = fib(tmp1);  
L3: tmp1 = tmp2 + tmp3;  
    return tmp1;  
}
```

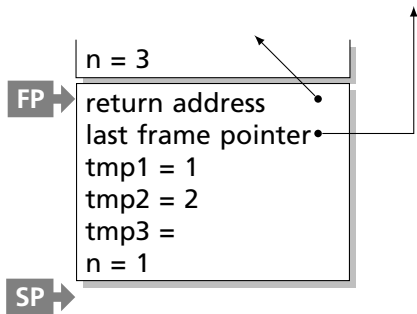

Executing fib(3)

```
int fib(int n) {  
    int tmp1, tmp2, tmp3;  
    tmp1 = n < 2;  
    if (!tmp1) goto L1;  
    return 1;  
L1: tmp1 = n - 1;  
    tmp2 = fib(tmp1);  
L2: tmp1 = n - 2;  
    tmp3 = fib(tmp1);  
L3: tmp1 = tmp2 + tmp3;  
    return tmp1;  
}
```

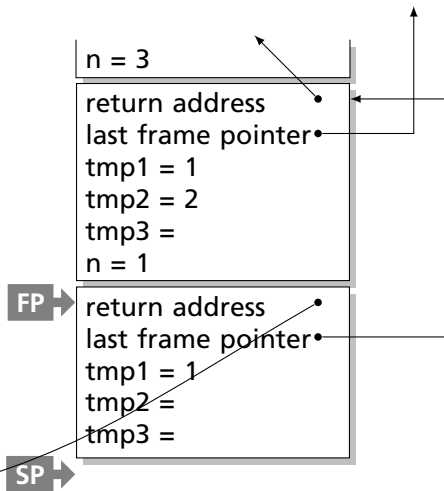

Executing fib(3)

```
int fib(int n) {  
    int tmp1, tmp2, tmp3;  
    tmp1 = n < 2;  
    if (!tmp1) goto L1;  
    return 1;  
L1: tmp1 = n - 1;  
    tmp2 = fib(tmp1);  
L2: tmp1 = n - 2;  
    tmp3 = fib(tmp1);  
L3: tmp1 = tmp2 + tmp3;  
    return tmp1;  
}
```

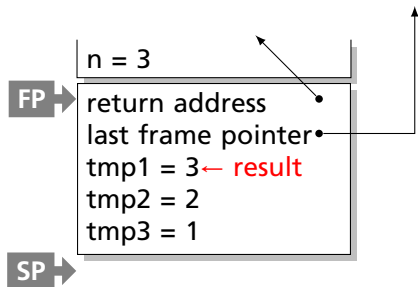

Allocating Fixed-Size Arrays

Local arrays with fixed size are easy to stack.

```
void foo()  
{  
    int a;  
    int b[10];  
    int c;  
}
```

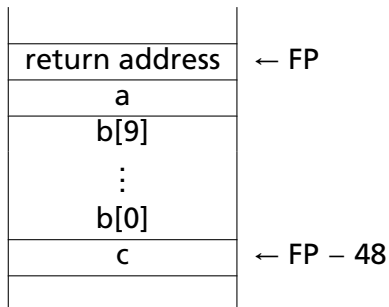

Allocating Variable-Sized Arrays

Variable-sized local arrays aren't as easy.

```
void foo(int n)
{
    int a;
    int b[n];
    int c;
}
```

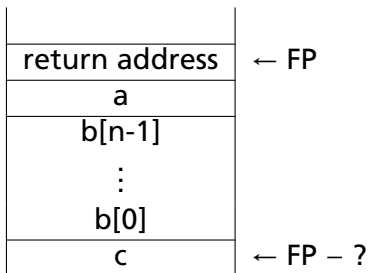

Doesn't work: generated code expects a fixed offset for c.
Even worse for multi-dimensional arrays.

Allocating Variable-Sized Arrays

As always:
add a level of indirection

```
void foo(int n)
{
    int a;
    int b[n];
    int c;
}
```

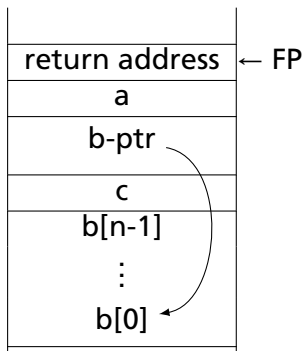

Variables remain constant offset from frame pointer.

Heap-Allocated Storage

Static works when you know everything beforehand and always need it.

Stack enables, but also requires, recursive behavior.

A *heap* is a region of memory where blocks can be allocated and deallocated in any order.

(These heaps are different than those in, e.g., heapsort)

Dynamic Storage Allocation in C

```
struct point {
    int x, y;
};

int play_with_points(int n)
{
    int i;
    struct point *points;

    points = malloc(n * sizeof(struct point));

    for ( i = 0 ; i < n ; i++ ) {
        points[i].x = random();
        points[i].y = random();
    }

    /* do something with the array */

    free(points);
}
```

Dynamic Storage Allocation



Dynamic Storage Allocation



↓ free()

Dynamic Storage Allocation



↓ free()



Dynamic Storage Allocation



↓ free()



↓ malloc()

Dynamic Storage Allocation



↓ free()



↓ malloc()



Dynamic Storage Allocation

Rules:

Each allocated block contiguous (no holes)

Blocks stay fixed once allocated

malloc()

Find an area large enough for requested block

Mark memory as allocated

free()

Mark the block as unallocated



Simple Dynamic Storage Allocation

Maintaining information about free memory

Simplest: Linked list

The algorithm for locating a suitable block

Simplest: First-fit

The algorithm for freeing an allocated block

Simplest: Coalesce adjacent free blocks

Simple Dynamic Storage Allocation

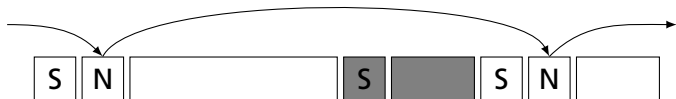

Simple Dynamic Storage Allocation

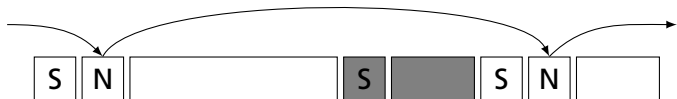

`malloc([shaded box])`

Simple Dynamic Storage Allocation

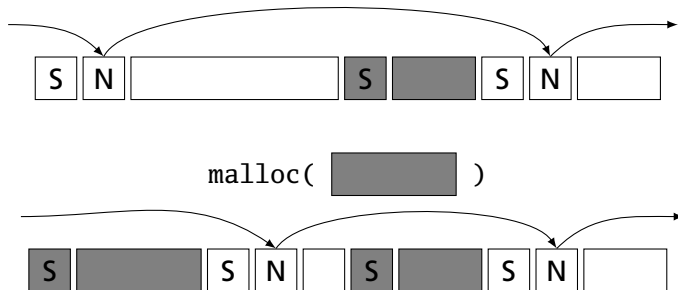

Simple Dynamic Storage Allocation

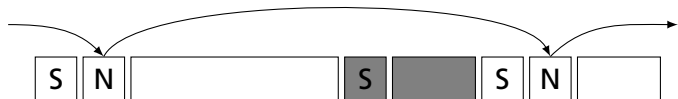

malloc()

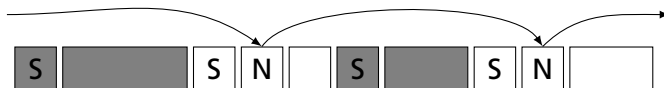

free()

Simple Dynamic Storage Allocation

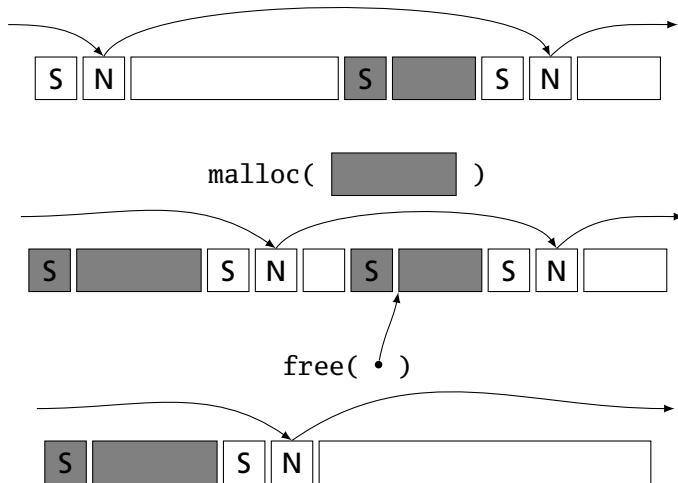

Fragmentation

malloc() seven times give



free() four times gives



malloc() ?

Need more memory; can't use fragmented memory.



Zebra



Tapir

Fragmentation and Handles

Standard CS solution: Add another layer of indirection.

Always reference memory through "handles."

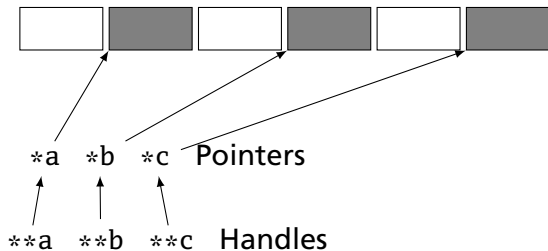

The original Macintosh did this to save memory.

Fragmentation and Handles

Standard CS solution: Add another layer of indirection.

Always reference memory through "handles."

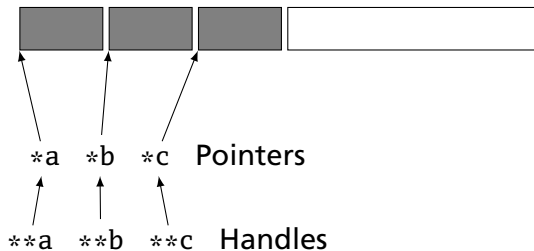

The original Macintosh did this to save memory.

Automatic Garbage Collection

Entrust the runtime system with freeing heap objects

Now common: Java, C#, Javascript, Python, Ruby, OCaml and most functional languages

Advantages

Much easier for the programmer

Greatly improves reliability: no memory leaks, double-freeing, or other memory management errors

Disadvantages

Slower, sometimes unpredictably so

May consume more memory



Reference Counting

What and when to free?

- ▶ Maintain count of references to each object
- ▶ Free when count reaches zero

```
let a = (42, 17) in  
let b = [a;a] in  
let c = (1,2)::b in  
b
```

0	42, 17
---	--------

Reference Counting

What and when to free?

- ▶ Maintain count of references to each object
- ▶ Free when count reaches zero

```
let a = (42, 17) in  
let b = [a;a] in  
let c = (1,2)::b in  
b
```

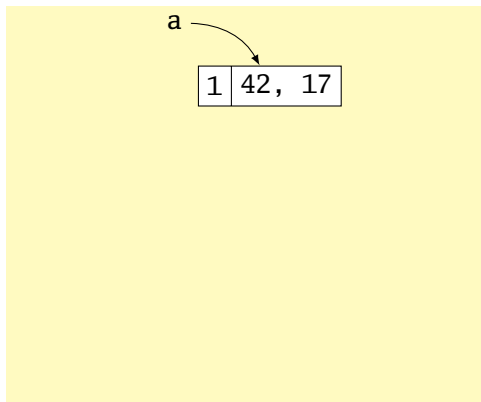

Reference Counting

What and when to free?

- ▶ Maintain count of references to each object
- ▶ Free when count reaches zero

```
let a = (42, 17) in
let b = [a;a] in
let c = (1,2)::b in
b
```

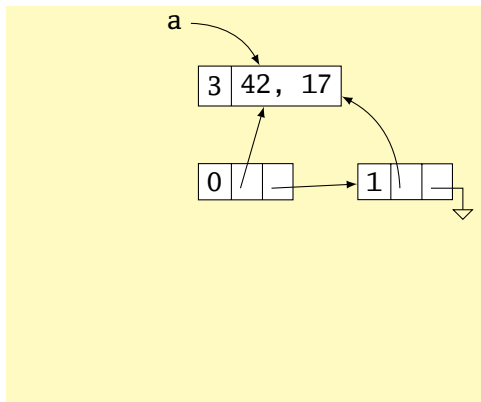

Reference Counting

What and when to free?

- ▶ Maintain count of references to each object
- ▶ Free when count reaches zero

```
let a = (42, 17) in  
let b = [a;a] in  
let c = (1,2)::b in  
b
```

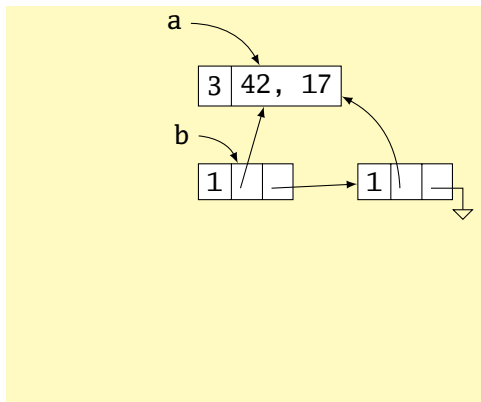

Reference Counting

What and when to free?

- ▶ Maintain count of references to each object
- ▶ Free when count reaches zero

```
let a = (42, 17) in  
let b = [a;a] in  
let c = (1,2)::b in  
b
```

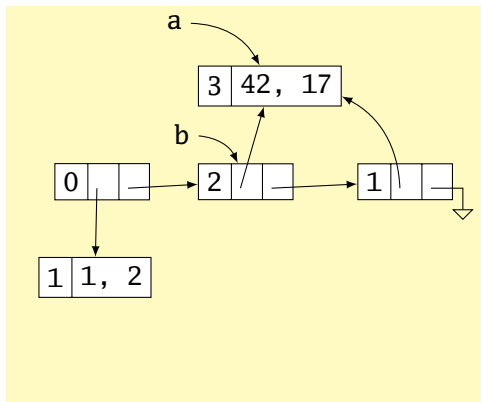

Reference Counting

What and when to free?

- ▶ Maintain count of references to each object
- ▶ Free when count reaches zero

```
let a = (42, 17) in  
let b = [a;a] in  
let c = (1,2)::b in  
b
```

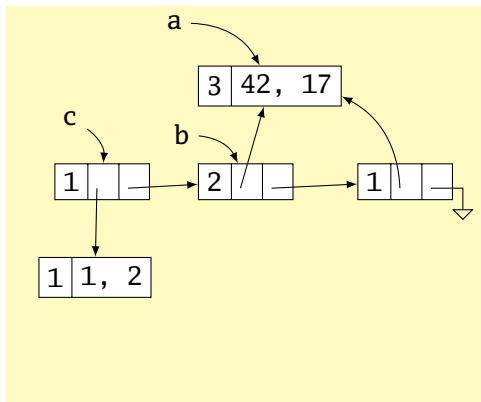

Reference Counting

What and when to free?

- ▶ Maintain count of references to each object
- ▶ Free when count reaches zero

```
let a = (42, 17) in  
let b = [a;a] in  
let c = (1,2)::b in  
b
```

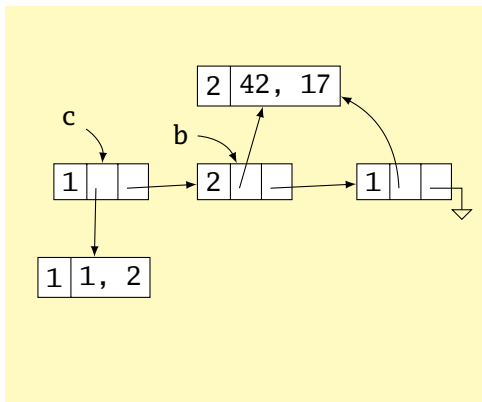

Reference Counting

What and when to free?

- ▶ Maintain count of references to each object
- ▶ Free when count reaches zero

```
let a = (42, 17) in
let b = [a;a] in
let c = (1,2)::b in
b
```

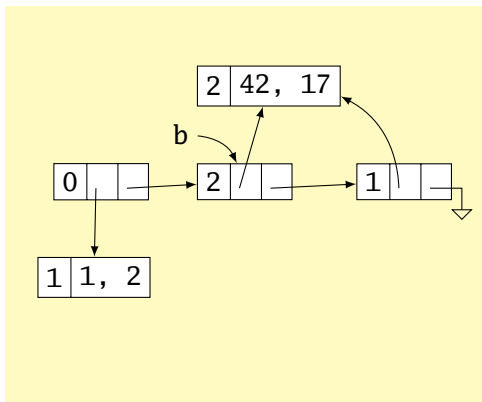

Reference Counting

What and when to free?

- ▶ Maintain count of references to each object
- ▶ Free when count reaches zero

```
let a = (42, 17) in  
let b = [a;a] in  
let c = (1,2)::b in  
b
```

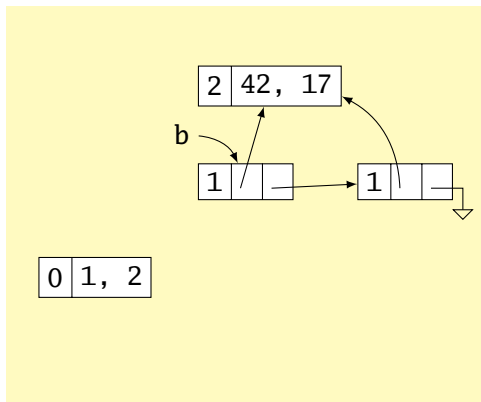

Reference Counting

What and when to free?

- ▶ Maintain count of references to each object
- ▶ Free when count reaches zero

```
let a = (42, 17) in  
let b = [a;a] in  
let c = (1,2)::b in  
b
```

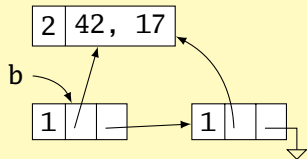

Issues with Reference Counting

Circular structures defy reference counting:



Neither is reachable, yet both have non-zero reference counts.

High overhead (must update counts constantly), although incremental

Mark-and-Sweep

What and when to free?

- ▶ Stop-the-world algorithm invoked when memory full
- ▶ Breadth-first-search marks all reachable memory
- ▶ All unmarked items freed

```
let a = (42, 17) in  
let b = [a;a] in  
let c = (1,2)::b in  
b
```

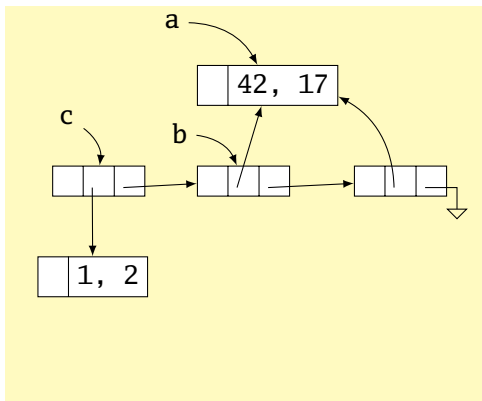

Mark-and-Sweep

What and when to free?

- ▶ Stop-the-world algorithm invoked when memory full
- ▶ Breadth-first-search marks all reachable memory
- ▶ All unmarked items freed

```
let a = (42, 17) in  
let b = [a;a] in  
let c = (1,2)::b in  
b
```

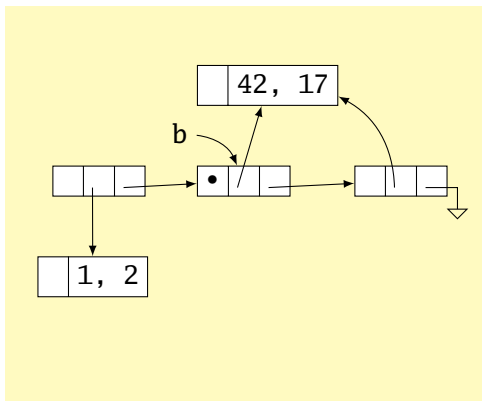

Mark-and-Sweep

What and when to free?

- ▶ Stop-the-world algorithm invoked when memory full
- ▶ Breadth-first-search marks all reachable memory
- ▶ All unmarked items freed

```
let a = (42, 17) in  
let b = [a;a] in  
let c = (1,2)::b in  
b
```

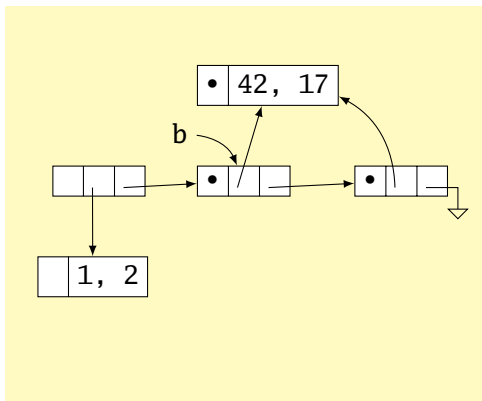

Mark-and-Sweep

What and when to free?

- ▶ Stop-the-world algorithm invoked when memory full
- ▶ Breadth-first-search marks all reachable memory
- ▶ All unmarked items freed

```
let a = (42, 17) in  
let b = [a;a] in  
let c = (1,2)::b in  
b
```

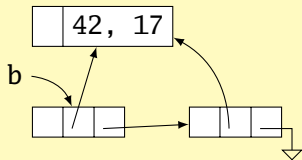

Mark-and-Sweep

Mark-and-sweep is faster overall; may induce big pauses

Mark-and-compact variant also moves or copies reachable objects to eliminate fragmentation

Incremental garbage collectors try to avoid doing everything at once

Most objects die young; generational garbage collectors segregate heap objects by age

Parallel garbage collection tricky

Real-time garbage collection tricky

Single Inheritance

Simple: Add new fields to end of the object

Fields in base class always at same offset in derived class
(compiler never reorders)

Consequence: Derived classes can never remove fields

C++

```
class Shape {  
    double x, y;  
};  
  
class Box : Shape {  
    double h, w;  
};  
  
class Circle : Shape {  
    double r;  
};
```

Equivalent C

```
struct Shape {  
    double x, y;  
};  
  
struct Box {  
    double x, y;  
    double h, w;  
};  
  
struct Circle {  
    double x, y;  
    double r;  
};
```

Virtual Functions

```
class Shape {  
    virtual void draw(); // Invoked by object's run-time class  
}; // not its compile-time type.  
  
class Line : public Shape {  
    void draw();  
}  
  
class Arc : public Shape {  
    void draw();  
};  
  
Shape *s[10];  
s[0] = new Line;  
s[1] = new Arc;  
s[0]->draw(); // Invoke Line::draw()  
s[1]->draw(); // Invoke Arc::draw()
```

Virtual Functions

Trick: add to each object a pointer to the virtual table for its type, filled with pointers to the virtual functions.

Like the objects themselves, the virtual table for each derived type begins identically.

```
struct A {  
    int x;  
    virtual void Foo();  
    virtual void Bar();  
};  
  
struct B : A {  
    int y;  
    virtual void Foo();  
    virtual void Baz();  
};  
  
A a1;  
A a2;  
B b1;
```

A's Vtbl

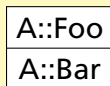

a1



a2



B's Vtbl

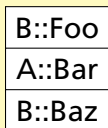

b1

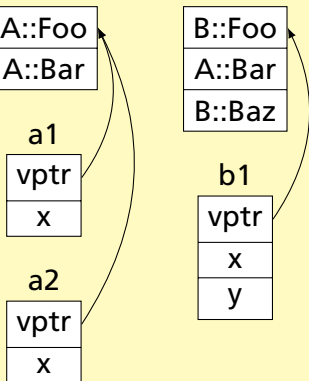
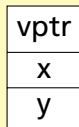

Stack-Based IR: Java Bytecode

```
int gcd(int a, int b) {  
    while (a != b) {  
        if (a > b)  
            a -= b;  
        else  
            b -= a;  
    }  
    return a;  
}
```

```
# javap -c Gcd
```

```
Method int gcd(int, int)
```

```
    0 goto 19  
  
    3 iload_1      // Push a  
    4 iload_2      // Push b  
    5 if_icmple 15 // if a <= b goto 15  
  
    8 iload_1      // Push a  
    9 iload_2      // Push b  
   10 isub        // a - b  
   11 istore_1     // Store new a  
   12 goto 19  
  
   15 iload_2      // Push b  
   16 iload_1      // Push a  
   17 isub        // b - a  
   18 istore_2     // Store new b  
  
   19 iload_1      // Push a  
   20 iload_2      // Push b  
   21 if_icmpne 3  // if a != b goto 3  
  
   24 iload_1      // Push a  
   25 ireturn     // Return a
```



Stack-Based IRs

Advantages:

- ▶ Trivial translation of expressions
- ▶ Trivial interpreters
- ▶ No problems with exhausting registers
- ▶ Often compact



Disadvantages:

- ▶ Semantic gap between stack operations and modern register machines
- ▶ Hard to see what communicates with what
- ▶ Difficult representation for optimization

Register-Based IR: Mach SUIF

```
int gcd(int a, int b) {  
    while (a != b) {  
        if (a > b)  
            a -= b;  
        else  
            b -= a;  
    }  
    return a;  
}
```



```
gcd:  
gcd._gcdTmp0:  
    sne    $vr1.s32 <- gcd.a,gcd.b  
    seq    $vr0.s32 <- $vr1.s32,0  
    btrue  $vr0.s32,gcd._gcdTmp1 // if!(a!=b) goto Tmp1  
  
    sl     $vr3.s32 <- gcd.b,gcd.a  
    seq    $vr2.s32 <- $vr3.s32,0  
    btrue  $vr2.s32,gcd._gcdTmp4 // if!(a<b) goto Tmp4  
  
    mrk    2, 4 // Line number 4  
    sub    $vr4.s32 <- gcd.a,gcd.b  
    mov    gcd._gcdTmp2 <- $vr4.s32  
    mov    gcd.a <- gcd._gcdTmp2 // a = a - b  
    jmp    gcd._gcdTmp5  
gcd._gcdTmp4:  
    mrk    2, 6  
    sub    $vr5.s32 <- gcd.b,gcd.a  
    mov    gcd._gcdTmp3 <- $vr5.s32  
    mov    gcd.b <- gcd._gcdTmp3 // b = b - a  
gcd._gcdTmp5:  
    jmp    gcd._gcdTmp0  
  
gcd._gcdTmp1:  
    mrk    2, 8  
    ret    gcd.a // Return a
```

Register-Based IRs



Most common type of IR

Advantages:

- ▶ Better representation for register machines
- ▶ Dataflow is usually clear

Disadvantages:

- ▶ Slightly harder to synthesize from code
- ▶ Less compact
- ▶ More complicated to interpret

Optimization In Action

```
int gcd(int a, int b) {  
    while (a != b) {  
        if (a < b) b -= a;  
        else a -= b;  
    }  
    return a;  
}
```



GCC on SPARC

```
gcd:  save %sp, -112, %sp  
      st  %i0, [%fp+68]  
      st  %i1, [%fp+72]  
.LL2: ld  [%fp+68], %i1  
      ld  [%fp+72], %i0  
      cmp %i1, %i0  
      bne .LL4  
      nop  
      b   .LL3  
      nop  
.LL4: ld  [%fp+68], %i1  
      ld  [%fp+72], %i0  
      cmp %i1, %i0  
      bge .LL5  
      nop  
      ld  [%fp+72], %i0  
      ld  [%fp+68], %i1  
      sub %i0, %i1, %i0  
      st  %i0, [%fp+72]  
      b   .LL2  
      nop  
.LL5: ld  [%fp+68], %i0  
      ld  [%fp+72], %i1  
      sub %i0, %i1, %i0  
      st  %i0, [%fp+68]  
      b   .LL2  
      nop  
.LL3: ld  [%fp+68], %i0  
      ret  
      restore
```

GCC -O7 on SPARC

```
gcd:  cmp  %o0, %o1  
      be  .LL8  
      nop  
.LL9: bge,a .LL2  
      sub %o0, %o1, %o0  
      sub %o1, %o0, %o1  
.LL2: cmp  %o0, %o1  
      bne .LL9  
      nop  
.LL8: retl  
      nop
```

Typical Optimizations

- ▶ Folding constant expressions

$1+3 \rightarrow 4$

- ▶ Removing dead code

`if (0) { ... }` \rightarrow nothing

- ▶ Moving variables from memory to registers

```
ld    [%fp+68], %i1
```

```
sub   %i0, %i1, %i0  $\rightarrow$  sub   %o1, %o0, %o1
```

```
st    %i0, [%fp+72]
```

- ▶ Removing unnecessary data movement
- ▶ Filling branch delay slots (Pipelined RISC processors)
- ▶ Common subexpression elimination

Machine-Dependent vs. -Independent Optimization

No matter what the machine is, folding constants and eliminating dead code is always a good idea.

```
a = c + 5 + 3;  
if (0 + 3) {  
    b = c + 8;  
}
```

→ b = a = c + 8;

However, many optimizations are processor-specific:

- ▶ Register allocation depends on how many registers the machine has
- ▶ Not all processors have branch delay slots to fill
- ▶ Each processor's pipeline is a little different

Basic Blocks



```
int gcd(int a, int b) {  
    while (a != b) {  
        if (a < b) b -= a;  
        else a -= b;  
    }  
    return a;  
}
```

lower
→

```
A: sne t, a, b  
   bz E, t  
   slt t, a, b  
   bnz B, t  
   sub b, b, a  
   jmp C  
B: sub a, a, b  
C: jmp A  
E: ret a
```

split
→

```
A: sne t, a, b  
   bz E, t  
   slt t, a, b  
   bnz B, t  
   sub b, b, a  
   jmp C  
B: sub a, a, b  
C: jmp A  
E: ret a
```

The statements in a basic block all run if the first one does.

Starts with a statement following a conditional branch or is a branch target.

Usually ends with a control-transfer statement.

Control-Flow Graphs

A CFG illustrates the flow of control among basic blocks.

```
A:  
sne t, a, b  
bz E, t
```

```
slt t, a, b  
bnz B, t
```

```
sub b, b, a  
jmp C
```

```
B:  
sub a, a, b
```

```
C:  
jmp A
```

```
E:  
ret a
```

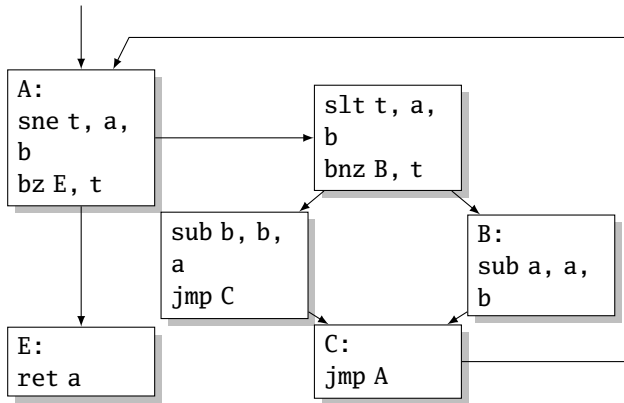

Lambda Expressions

Function application written in prefix form. “Add four and five” is

(+ 4 5)

Evaluation: select a *redex* and evaluate it:

(+ (* 5 6) (* 8 3)) → (+ 30 (* 8 3))
→ (+ 30 24)
→ 54

Often more than one way to proceed:

(+ (* 5 6) (* 8 3)) → (+ (* 5 6) 24)
→ (+ 30 24)
→ 54

Simon Peyton Jones, *The Implementation of Functional Programming Languages*, Prentice-Hall, 1987.

Function Application and Currying



Function application is written as juxtaposition:

$$f x$$

Every function has exactly one argument.

Multiple-argument functions, e.g., $+$, are represented by *currying*, named after Haskell Brooks Curry (1900–1982). So,

$$(+ x)$$

is the function that adds x to its argument.

Function application associates left-to-right:

$$\begin{aligned} (+ 3 4) &= ((+ 3) 4) \\ &\rightarrow 7 \end{aligned}$$

Lambda Abstraction

The only other thing in the lambda calculus is *lambda abstraction*: a notation for defining unnamed functions.

$(\lambda x . + x 1)$

(λ x . + x 1)
 \uparrow \uparrow \uparrow \uparrow \uparrow \uparrow
 That function of x that adds x to 1

The Syntax of the Lambda Calculus

```
expr ::= expr expr  
       |  $\lambda$  variable . expr  
       | constant  
       | variable  
       | (expr)
```

Constants are numbers and built-in functions;
variables are identifiers.

Beta-Reduction

Evaluation of a lambda abstraction—*beta-reduction*—is just substitution:

$$\begin{aligned}(\lambda x . + x 1) 4 &\rightarrow (+ 4 1) \\ &\rightarrow 5\end{aligned}$$

The argument may appear more than once

$$\begin{aligned}(\lambda x . + x x) 4 &\rightarrow (+ 4 4) \\ &\rightarrow 8\end{aligned}$$

or not at all

$$(\lambda x . 3) 5 \rightarrow 3$$

Free and Bound Variables

$$(\lambda x . + x y) 4$$

Here, x is like a function argument but y is like a global variable.

Technically, x occurs *bound* and y occurs *free* in

$$(\lambda x . + x y)$$

However, both x and y occur free in

$$(+ x y)$$

Beta-Reduction More Formally

$$(\lambda x . E) F \rightarrow_{\beta} E'$$

where E' is obtained from E by replacing every instance of x that appears free in E with F .

The definition of free and bound mean variables have scopes. Only the rightmost x appears free in

$$(\lambda x . + (- x 1)) x 3$$

so

$$\begin{aligned}(\lambda x . (\lambda x . + (- x 1)) x 3) 9 &\rightarrow (\lambda x . + (- x 1)) 9 3 \\ &\rightarrow + (- 9 1) 3 \\ &\rightarrow + 8 3 \\ &\rightarrow 11\end{aligned}$$

Alpha-Conversion

One way to confuse yourself less is to do α -conversion: renaming a λ argument and its bound variables.

Formal parameters are only names: they are correct if they are consistent.

$$\begin{aligned}(\lambda x . (\lambda x . + (- x 1)) x 3) 9 &\leftrightarrow (\lambda x . (\lambda y . + (- y 1)) x 3) 9 \\ &\rightarrow ((\lambda y . + (- y 1)) 9 3) \\ &\rightarrow (+ (- 9 1) 3) \\ &\rightarrow (+ 8 3) \\ &\rightarrow 11\end{aligned}$$

Beta-Abstraction and Eta-Conversion

Running β -reduction in reverse, leaving the “meaning” of a lambda expression unchanged, is called *beta abstraction*:

$$+ 4 1 \leftarrow (\lambda x . + x 1) 4$$

Eta-conversion is another type of conversion that leaves “meaning” unchanged:

$$(\lambda x . + 1 x) \leftrightarrow_{\eta} (+ 1)$$

Formally, if F is a function in which x does not occur free,

$$(\lambda x . F x) \leftrightarrow_{\eta} F$$

Reduction Order

The order in which you reduce things can matter.

$$(\lambda x . \lambda y . y) ((\lambda z . z z) (\lambda z . z z))$$

Two things can be reduced:

$$(\lambda z . z z) (\lambda z . z z)$$

$$(\lambda x . \lambda y . y) (\dots)$$

However,

$$(\lambda z . z z) (\lambda z . z z) \rightarrow (\lambda z . z z) (\lambda z . z z)$$

$$(\lambda x . \lambda y . y) (\dots) \rightarrow (\lambda y . y)$$

Normal Form

A lambda expression that cannot be β -reduced is in *normal form*. Thus,

$$\lambda y . y$$

is the normal form of

$$(\lambda x . \lambda y . y) ((\lambda z . z z) (\lambda z . z z))$$

Not everything has a normal form. E.g.,

$$(\lambda z . z z) (\lambda z . z z)$$

can only be reduced to itself, so it never produces an non-reducible expression.

Normal Form

Can a lambda expression have more than one normal form?

Church-Rosser Theorem I: If $E_1 \leftrightarrow E_2$, then there exists an expression E such that $E_1 \rightarrow E$ and $E_2 \rightarrow E$.

Corollary. No expression may have two distinct normal forms.

Proof. Assume E_1 and E_2 are distinct normal forms for E : $E \leftrightarrow E_1$ and $E \leftrightarrow E_2$. So $E_1 \leftrightarrow E_2$ and by the Church-Rosser Theorem I, there must exist an F such that $E_1 \rightarrow F$ and $E_2 \rightarrow F$. However, since E_1 and E_2 are in normal form, $E_1 = F = E_2$, a contradiction.

Normal-Order Reduction

Not all expressions have normal forms, but is there a reliable way to find the normal form if it exists?

Church-Rosser Theorem II: If $E_1 \rightarrow E_2$ and E_2 is in normal form, then there exists a *normal order* reduction sequence from E_1 to E_2 .

Normal order reduction: reduce the leftmost outermost redex.

Normal-Order Reduction

$$\left((\lambda x . ((\lambda w . \lambda z . + w z) 1)) ((\lambda x . x x) (\lambda x . x x)) \right) ((\lambda y . + y 1) (+ 2 3))$$

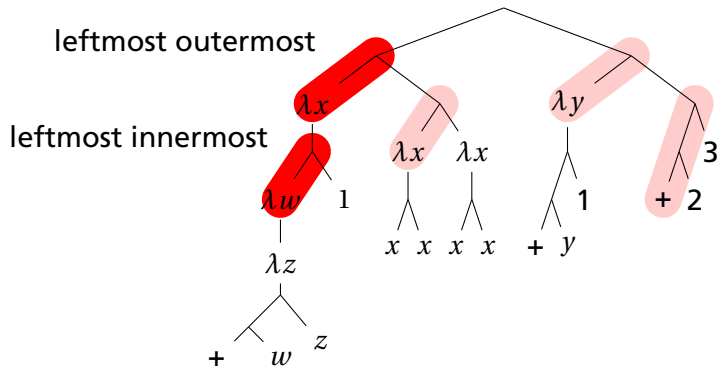

Recursion

Where is recursion in the lambda calculus?

$$FAC = \left(\lambda n . IF (= n 0) 1 \left(* n (FAC (- n 1)) \right) \right)$$

This does not work: functions are unnamed in the lambda calculus. But it is possible to express recursion *as a function*.

$$\begin{aligned} FAC &= (\lambda n . \dots FAC \dots) \\ &\leftarrow_{\beta} (\lambda f . (\lambda n . \dots f \dots)) FAC \\ &= H FAC \end{aligned}$$

That is, the factorial function, FAC , is a *fixed point* of the (non-recursive) function H :

$$H = \lambda f . \lambda n . IF (= n 0) 1 (* n (f (- n 1)))$$

Recursion

Let's invent a function Y that computes FAC from H , i.e.,
 $FAC = Y H$:

$$\begin{aligned} FAC &= H FAC \\ Y H &= H (Y H) \end{aligned}$$

$$\begin{aligned} FAC\ 1 &= Y\ H\ 1 \\ &= H\ (Y\ H)\ 1 \\ &= (\lambda f . \lambda n . IF\ (= n\ 0)\ 1\ (*\ n\ (f\ (-\ n\ 1))))\ (Y\ H)\ 1 \\ &\rightarrow (\lambda n . IF\ (= n\ 0)\ 1\ (*\ n\ ((Y\ H)\ (-\ n\ 1))))\ 1 \\ &\rightarrow IF\ (= 1\ 0)\ 1\ (*\ 1\ ((Y\ H)\ (-\ 1\ 1))) \\ &\rightarrow * 1\ (Y\ H\ 0) \\ &= * 1\ (H\ (Y\ H)\ 0) \\ &= * 1\ ((\lambda f . \lambda n . IF\ (= n\ 0)\ 1\ (*\ n\ (f\ (-\ n\ 1))))\ (Y\ H)\ 0) \\ &\rightarrow * 1\ ((\lambda n . IF\ (= n\ 0)\ 1\ (*\ n\ (Y\ H\ (-\ n\ 1))))\ 0) \\ &\rightarrow * 1\ (IF\ (= 0\ 0)\ 1\ (*\ 0\ (Y\ H\ (-\ 0\ 1)))) \\ &\rightarrow * 1\ 1 \\ &\rightarrow 1 \end{aligned}$$

The Y Combinator

Here's the eye-popping part: Y can be a simple lambda expression.

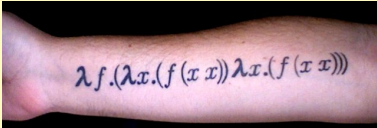
$$Y = \lambda f . (\lambda x . f (x x)) (\lambda x . f (x x))$$

$$= \lambda f . (\lambda x . f (x x)) (\lambda x . f (x x))$$

$$\begin{aligned} Y H &= \left(\lambda f . (\lambda x . f (x x)) (\lambda x . f (x x)) \right) H \\ &\rightarrow (\lambda x . H (x x)) (\lambda x . H (x x)) \\ &\rightarrow H \left((\lambda x . H (x x)) (\lambda x . H (x x)) \right) \\ &\leftrightarrow H \left(\left(\lambda f . (\lambda x . f (x x)) (\lambda x . f (x x)) \right) H \right) \\ &= H (Y H) \end{aligned}$$

“Y: The function that takes a function f and returns $f(f(f(f(\dots))))$ ”