

The VHDL Hardware Description Language

Prof. Stephen A. Edwards
sedwards@cs.columbia.edu

Columbia University
Spring 2006

Why HDLs?

1970s: SPICE transistor-level netlists

An XOR built from four NAND gates

```
.MODEL P PMOS
.MODEL N NMOS

.SUBCKT NAND A B Y Vdd Vss
M1 Y A Vdd Vdd P
M2 Y B Vdd Vdd P
M3 Y A X Vss N
M4 X B Vss Vss N
.ENDS
```

```
X1 A B I1 Vdd 0 NAND
X2 A I1 I2 Vdd 0 NAND
X3 B I1 I3 Vdd 0 NAND
X4 I2 I3 Y Vdd 0 NAND
```

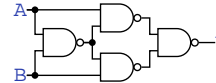
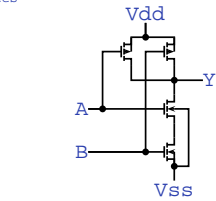

Why HDLs?

1980s: Graphical schematic capture programs

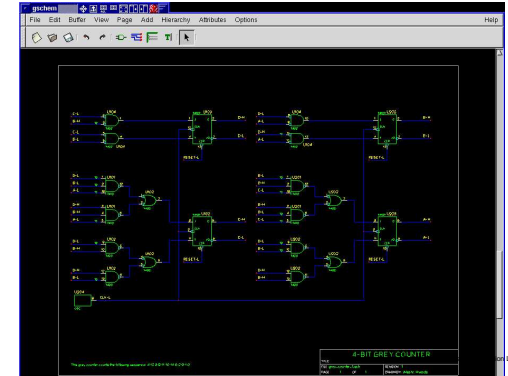

Why HDLs?

1990s: HDLs and Logic Synthesis

```
library ieee;
use ieee.std_logic_1164.all;
use ieee.std_logic_unsigned.all;
use ieee.std_logic_arith.all;
entity ALU is
port( A: in std_logic_vector(1 downto 0);
      B: in std_logic_vector(1 downto 0);
      Sel: in std_logic_vector(1 downto 0);
      Res: out std_logic_vector(1 downto 0));
end ALU;
architecture behv of ALU is begin
  process(A,B,Sel) begin
    case Sel is
      when "00" => Res <= A + B;
      when "01" => Res <= A + (not B) + 1;
      when "10" => Res <= A and B;
      when "11" => Res <= A or B;
      when others => Res <= "XX";
    end case;
  end process;
```

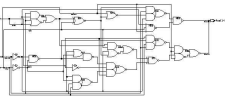

Two Separate but Equal Languages



Verilog and VHDL
Verilog: More succinct, less flexible, really messy
VHDL: Verbose, very (too?) flexible, fairly messy
Part of languages people actually use identical.
Every synthesis system supports both.

VHDL: Hierarchical Models

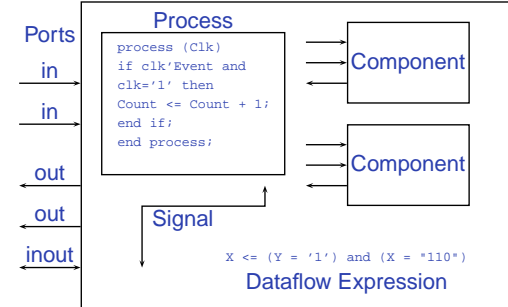

Basic VHDL: Full Adder

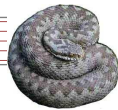

```
library ieee;
use ieee.std_logic_1164.all;
entity full_adder is
port(a, b, c : in std_ulogic;
      sum, carry : out std_ulogic);
end full_adder;
architecture imp of full_adder is
begin
  sum <= (a xor b) xor c; -- combinational logic
  carry <= (a and b) or (a and c) or (b and c);
end imp;
```

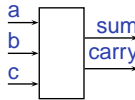

VHDL: Two-bit Counter



```
library ieee;
use ieee.std_logic_1164.all;
entity add2 is
port ( A, B : in std_logic_vector(1 downto 0);
       C : out std_logic_vector(2 downto 0));
end add2;
architecture imp of add2 is
  component full_adder
  port ( a, b, c : in std_ulogic;
        sum, carry : out std_ulogic);
  end component;
  signal carry : std_ulogic;
begin
  bit0 : full_adder port map (
    a => A(0),
    b => B(0),
    c => '0',
    sum => C(0),
    carry => carry);
  bit1 : full_adder port map (
    a => A(1),
    b => B(1),
    c => carry,
    sum => C(1),
    carry => C(2));
```

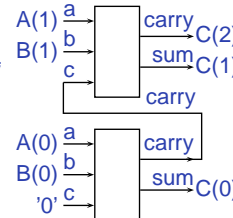

Four-to-one multiplexer: when...else

```
library ieee;
use ieee.std_logic_1164.all;
entity multiplexer_4_1 is
port(in0, in1 : in std_ulogic_vector(15 downto 0);
      in2, in3 : in std_ulogic_vector(15 downto 0);
      s0, s1 : in std_ulogic;
      z : out std_ulogic_vector(15 downto 0));
end multiplexer_4_1;
architecture imp of multiplexer_4_1 is
begin
  z <= in0 when (s0 = '0' and s1 = '0') else
    in1 when (s0 = '1' and s1 = '0') else
    in2 when (s0 = '0' and s1 = '1') else
    in3 when (s0 = '1' and s1 = '1') else
    "XXXXXXXXXXXXXXXXXX";
end imp;
```

Four-to-one mux: with...select

```
library ieee;
use ieee.std_logic_1164.all;

entity multiplexer_4_1 is
  port(in0, in1 : in  std_logic_vector(15 downto 0);
        in2, in3 : in  std_logic_vector(15 downto 0);
        s0, s1  : in  std_logic;
        z      : out std_logic_vector(15 downto 0));
end multiplexer_4_1;

architecture usewith of multiplexer_4_1 is
  signal sels : std_logic_vector(1 downto 0);
begin
  sels <= s1 & s0; -- Vector concatenation

  with sels select
    z <=
      in0      when "00",
      in1      when "01",
      in2      when "10",
      in3      when "11",
      "XXXXXXXXXXXXXXXX" when others;
end usewith;
```

The VHDL Hardware Description Language -- p. 103

Three-to-eight Decoder

```
library ieee;
use ieee.std_logic_1164.all;

entity decl_8 is
  port (
    sel : in  std_logic_vector(2 downto 0);
    res : out std_logic_vector(7 downto 0));
end decl_8;

architecture imp of decl_8 is
begin
  res <= "00000001" when sel = "000" else
        "00000010" when sel = "001" else
        "00000100" when sel = "010" else
        "00001000" when sel = "011" else
        "00010000" when sel = "100" else
        "00100000" when sel = "101" else
        "01000000" when sel = "110" else
        "10000000";
end imp;
```

The VHDL Hardware Description Language -- p. 103

Priority Encoder



```
library ieee;
use ieee.std_logic_1164.all;

entity priority is
  port (
    sel : in  std_logic_vector(7 downto 0);
    code : out std_logic_vector(2 downto 0));
end priority;

architecture imp of priority is
begin
  code <= "000" when sel(0) = '1' else
        "001" when sel(1) = '1' else
        "010" when sel(2) = '1' else
        "011" when sel(3) = '1' else
        "100" when sel(4) = '1' else
        "101" when sel(5) = '1' else
        "110" when sel(6) = '1' else
        "111" when sel(7) = '1' else
        "---"; -- "-" is "don't care"
end imp;
```

The VHDL Hardware Description Language -- p. 103

Integer Arithmetic



```
library ieee;
use ieee.std_logic_1164.all;
use ieee.std_logic_arith.all;
use ieee.std_logic_unsigned.all;

entity adder is
  port (
    A, B : in  std_logic_vector(7 downto 0);
    CI   : in  std_logic;
    SUM  : out std_logic_vector(7 downto 0);
    CO   : out std_logic);
end adder;

architecture imp of adder is
  signal tmp : std_logic_vector(8 downto 0);
begin
  tmp <= conv_std_logic_vector((conv_integer(A) +
                               conv_integer(B) +
                               conv_integer(CI)), 9);

  SUM <= tmp(7 downto 0);
  CO  <= tmp(8);
end imp;
```

The VHDL Hardware Description Language -- p. 133

A Very Simple ALU

```
library ieee;
use ieee.std_logic_1164.all;
use ieee.std_logic_unsigned.all;

entity alu is
  port (
    A, B : in  std_logic_vector(7 downto 0);
    ADD  : in  std_logic;
    RES  : out std_logic_vector(7 downto 0));
end alu;

architecture imp of alu is
begin
  RES <= A + B when ADD = '1' else
        A - B;
end imp;
```

The VHDL Hardware Description Language -- p. 143

Arithmetic Comparison

```
library ieee;
use ieee.std_logic_1164.all;
use ieee.std_logic_unsigned.all;

entity comparator is
  port (
    A, B : in  std_logic_vector(7 downto 0);
    GE   : out std_logic);
end comparator;

architecture imp of comparator is
begin
  GE <= '1' when A >= B else '0';
end imp;
```

The VHDL Hardware Description Language -- p. 153

Generate: Ripple-carry adder

```
library ieee;
use ieee.std_logic_1164.all;

entity rippleadder is
  port (a, b : in  std_logic_vector(3 downto 0);
        cin : in  std_logic;
        sum : out std_logic_vector(3 downto 0);
        cout : out std_logic);
end rippleadder;

architecture imp of rippleadder is
  signal c : std_logic_vector(4 downto 0);
begin
  c(0) <= cin;
  G1: for m in 0 to 3 generate -- at compile time
    sum(m) <= a(m) xor b(m) xor c(m);
    c(m+1) <= (a(m) and b(m)) or (b(m) and c(m)) or
              (a(m) and c(m));
  end generate G1;
  cout <= c(4);
end imp;
```

Basic Flip-Flop



```
library ieee;
use ieee.std_logic_1164.all;

entity flipflop is
  port (Clk, D : in  std_logic;
        Q      : out std_logic);
end flipflop;

architecture imp of flipflop is
begin
  process (Clk) -- Process sensitive to Clk
  begin
    if (Clk'event and Clk = '1') then -- Rising edge
      Q <= D;
    end if;
  end process P1;
end imp;
```

Flip-Flop with Synchronous Reset

```
library ieee;
use ieee.std_logic_1164.all;

entity flipflop_reset is
  port (Clk, Reset, D : in  std_logic;
        Q      : out std_logic);
end flipflop_reset;

architecture imp of flipflop_reset is
begin
  P1: process (Clk)
  begin
    if (Clk'event and Clk = '1') then
      if (Reset = '1') then Q <= '0';
      else Q <= D;
      end if;
    end if;
  end process P1;
end imp;
```

Four-bit binary counter



```

library ieee;
use ieee.std_logic_1164.all;
use ieee.std_logic_unsigned.all;

entity counter is
    port(
        Clk, Reset : in std_logic;
        Q          : out std_logic_vector(3 downto 0));
end counter;

architecture imp of counter is
    signal count : std_logic_vector(3 downto 0);
begin
    process (Clk)
    begin
        if (Clk'event and Clk = '1') then
            if (Reset = '1') then
                count <= "0000";
            else
                count <= count + 1;
            end if;
        end if;
    end process;

    Q <= count; -- copy count to output
end imp;

```

The VHDL Hardware Description Language - p. 193

Eight-bit serial in/out shift register

```

library ieee;
use ieee.std_logic_1164.all;

entity shifter is
    port (
        Clk : in std_logic;
        SI  : in std_logic;
        SO  : out std_logic);
end shifter;

architecture impl of shifter is
    signal tmp : std_logic_vector(7 downto 0);
begin
    process (Clk)
    begin
        if (Clk'event and Clk = '1') then
            for i in 0 to 6 loop -- unrolled at compile time
                tmp(i+1) <= tmp(i);
            end loop;
            tmp(0) <= SI;
        end if;
    end process;

    SO <= tmp(7); -- Copy to output
end impl;

```

The VHDL Hardware Description Language - p. 203

A small RAM



```

library ieee;
use ieee.std_logic_1164.all;
use ieee.std_logic_unsigned.all;

entity ram_32_4 is
    port (
        Clk : in std_logic;
        WE  : in std_logic; -- Write enable
        EN  : in std_logic; -- Read enable
        addr : in std_logic_vector(4 downto 0);
        di   : in std_logic_vector(3 downto 0); -- Data in
        do   : out std_logic_vector(3 downto 0); -- Data out
    end ram_32_4;

architecture imp of ram_32_4 is
    type ram_type is array(31 downto 0) of std_logic_vector(3 downto 0);
    signal RAM : ram_type;
begin
    process (Clk)
    begin
        if (Clk'event and Clk = '1') then
            if (en = '1') then
                if (we = '1') then
                    RAM(conv_integer(addr)) <= di;
                else
                    do <= RAM(conv_integer(addr));
                end if;
            end if;
        end if;
    end process;
end imp;

```

The VHDL Hardware Description Language - p. 213

A small ROM

```

library ieee;
use ieee.std_logic_1164.all;
use ieee.std_logic_unsigned.all;

entity rom_32_4 is
    port (
        Clk : in std_logic;
        en  : in std_logic; -- Read enable
        addr : in std_logic_vector(4 downto 0);
        data : out std_logic_vector(3 downto 0);
    end rom_32_4;

architecture imp of rom_32_4 is
    type rom_type is array(31 downto 0) of std_logic_vector(3 downto 0);
    constant ROM : rom_type :=
        ("0001", "0010", "0011", "0100", "0101", "0110", "0111", "1000",
         "1001", "1010", "1011", "1100", "1101", "1110", "1111", "0001",
         "0010", "0011", "0100", "0101", "0110", "0111", "1000", "1001",
         "1010", "1011", "1100", "1101", "1110", "1111", "0000", "0010");
begin
    process (Clk)
    begin
        if (Clk'event and Clk = '1') then
            if (en = '1') then
                data <= ROM(conv_integer(addr));
            end if;
        end process;
    end imp;

```

The VHDL Hardware Description Language - p. 223

Rocket Science: FSMs

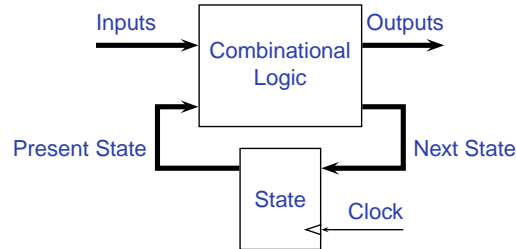

The VHDL Hardware Description Language - p. 233

Structure of FSMs in VHDL

```

entity myFSM is
    port( ... );
end myFSM;

architecture imp of myFSM is
    constant STATE1 := "...";
    constant STATE2 := "...";
    signal current_state, next_state : ...;

    process (clk) -- State holding element process
    begin
        if (clk'event and clk = '1') then
            current_state <= next_state;
        end if;
    end process;

    process (inputs...) -- Outputs and next state function
    begin
        if (reset = '1') then
            next_state <= STATE1;
        else
            case current_state is
                when STATE1 =>
                    output1 <= '1';
                    next_state <= STATE2;
                when STATE2 =>
                    ...
                    next_state <= STATE3;
            end case;
        end if;
    end process;
end imp;

```

The VHDL Hardware Description Language - p. 243

The Traffic Light Controller

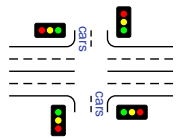

This controls a traffic light at the intersection of a busy highway and a farm road. Normally, the highway light is green but if a sensor detects a car on the farm road, the highway light turns yellow then red. The farm road light then turns green until there are no cars or after a long timeout. Then, the farm road light turns yellow then red, and the highway light returns to green. The inputs to the machine are the car sensor, a short timeout signal, and a long timeout signal. The outputs are a timer start signal and the colors of the highway and farm road lights.

Source: Mead and Conway, *Introduction to VLSI Systems*, 1980, p. 85.

FSM for the Traffic Light Controller

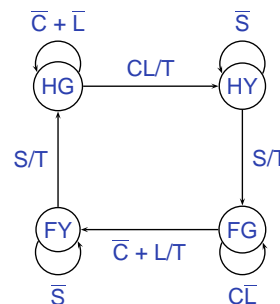

C: Car sensor
S: Short timeout
L: Long timeout
T: Start timer

St	Hwy	Farm
HG	G	R
HY	Y	R
FG	R	G
FY	R	Y

Traffic Light Controller in VHDL (1)

```

library ieee;
use ieee.std_logic_1164.all;

entity tlc is
    port (
        clk          : in std_ulogic;
        reset        : in std_ulogic;
        cars         : in std_ulogic;
        short        : in std_ulogic;
        long         : in std_ulogic;
        highway_yellow : out std_ulogic;
        highway_red   : out std_ulogic;
        farm_yellow   : out std_ulogic;
        farm_red      : out std_ulogic;
        start_timer   : out std_ulogic);
end tlc;

```

Traffic Light Controller in VHDL (2)

```
architecture imp of tlc is
    signal current_state, next_state : std_ulogic_vector;
    constant HG : std_ulogic_vector := "00";
    constant HY : std_ulogic_vector := "01";
    constant FY : std_ulogic_vector := "10";
    constant FG : std_ulogic_vector := "11";
begin

    P1: process (clk) -- Sequential process
    begin
        if (clk'event and clk = '1') then
            current_state <= next_state;
        end if;
    end process P1;
```

The VHDL Hardware Description Language -- p. 293

Traffic Light Controller in VHDL (3)

```
-- Combinational process
-- Sensitive to input changes, not clock

P2: process (current_state, reset, cars, short, long)
begin
    if (reset = '1') then
        next_state <= HG;
        start_timer <= '1';
    else
        case current_state is
            when HG =>
                highway_yellow <= '0';
                highway_red <= '0';
                farm_yellow <= '0';
                farm_red <= '1';
                if (cars = '1' and long = '1') then
                    next_state <= HY;
                    start_timer <= '1';
                else
                    next_state <= HG;
                    start_timer <= '0';
                end if;
            end if;
```

The VHDL Hardware Description Language -- p. 293

Traffic Light Controller in VHDL (4)

```
        when HY =>
            highway_yellow <= '1';
            highway_red <= '0';
            farm_yellow <= '0';
            farm_red <= '1';
            if (short = '1') then
                next_state <= FG;
                start_timer <= '1';
            else
                next_state <= HY;
                start_timer <= '0';
            end if;
        when FG =>
            highway_yellow <= '0';
            highway_red <= '1';
            farm_yellow <= '0';
            farm_red <= '0';
            if (cars = '0' or long = '1') then
                next_state <= FY;
                start_timer <= '1';
            else
                next_state <= FG;
                start_timer <= '0';
            end if;
```

The VHDL Hardware Description Language -- p. 303

Traffic Light Controller in VHDL (5)

```
        when FY =>
            highway_yellow <= '0';
            highway_red <= '1';
            farm_yellow <= '1';
            farm_red <= '0';
            if (short = '1') then
                next_state <= HG;
                start_timer <= '1';
            else
                next_state <= FY;
                start_timer <= '0';
            end if;
        when others =>
            next_state <= "XX";
            start_timer <= 'X';
            highway_yellow <= 'X';
            highway_red <= 'X';
            farm_yellow <= 'X';
            farm_red <= 'X';
        end case;
    end if;
end process P2;

end imp;
```

The VHDL Hardware Description Language -- p. 313