

The On-Chip Peripheral Bus

Prof. Stephen A. Edwards
sedwards@cs.columbia.edu

Columbia University
Spring 2006

The On-Chip Peripheral Bus

Developed by IBM

Part of their CoreConnect architecture designed for integrating on-chip "cores"

Something like "PCI on a chip"

Spec. allows for 32- or 64-bit addresses and data

Xilinx Microblaze variant uses 32-bit only

Intended System Architecture

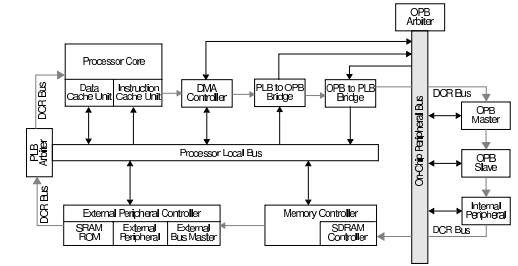

Source: IBM

Physical Implementation

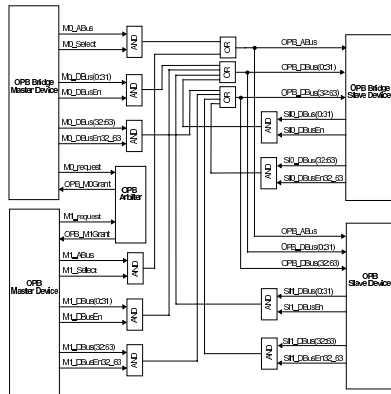

Masters and Slaves

Most bus protocols draw a distinction between

Masters: Can initiate a transaction, specify an address, etc. E.g., the Microblaze

Slaves: Respond to requests from masters, can generate return data. E.g., a video controller

Most peripherals are slaves.

Masters speak a more complex protocol

Bus arbiter decides which master gains control

Naming Conventions

For OPB slave devices,

prefix meaning

OPB_ Signals from OPB bus logic to slave

Sl_ Signals from slave to OPB

OPB slave signals (Xilinx)

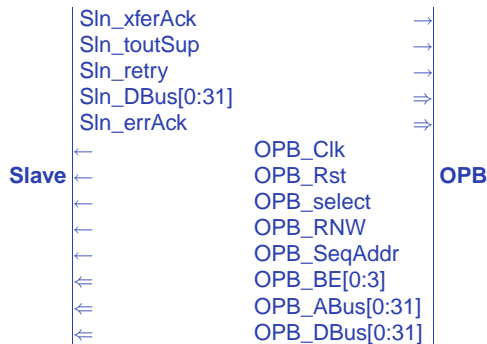

OPB Signals

- OPB_Clk Bus clock: master synchronization
- OPB_Rst Global asynchronous reset
- OPB_ABus[0:31] Address
- OPB_BE[0:3] Byte enable
- OPB_DBus[0:31] Data to slave
- OPB_RNW 1=read from slave, 0=write to slave
- OPB_select Transfer in progress
- OPB_seqAddr Next sequential address pending (unused)

- Sln_DBus[0:31] Data from slave. Must be 0 when inactive
- Sln_xferAck Transfer acknowledge. OPB_select=0
- Sln_retry Request master to retry operation (=0)
- Sln_toutSup Suppress slave time-out (=0)
- Sln_errAck Signal a transfer error occurred (=0)

Bytes, Bits, and Words

The OPB and the Microblaze are big-endian:

0 is the most significant bit, 31 is the least

Bytes and halfwords are left-justified:

	msb								lsb
Byte	0	1	2	3					
Bit	0	7	8	15	16	23	24	31	
Word	0								31
Halfword	0		15						
Byte	0		7						

In VHDL

```

entity opb_peripheral is
  generic (
    C_BASEADDR : std_logic_vector(0 to 31) := X"FFFFFFF";
    C_HIGHADDR : std_logic_vector(0 to 31) := X"00000000";
    C_OPB_AWIDTH : integer := 32;
    C_OPB_DWIDTH : integer := 32);
  port (
    OPB_ABus : in std_logic_vector(0 to C_OPB_AWIDTH-1);
    OPB_BE : in std_logic_vector(0 to C_OPB_DWIDTH/8-1);
    OPB_clk : in std_logic;
    OPB_DBus : in std_logic_vector(0 to C_OPB_DWIDTH-1);
    OPB_RNW : in std_logic;
    OPB_Rst : in std_logic;
    OPB_select : in std_logic;
    OPB_segAddr : in std_logic;
    Sln_DBus : out std_logic_vector(0 to C_OPB_DWIDTH-1);
    Sln_errAck : out std_logic;
    Sln_retry : out std_logic;
    Sln_toutSup : out std_logic;
    Sln_xferAck : out std_logic);
end entity opb_peripheral;

```

The On-Chip Peripheral Bus -- p. 103

Typical OPB Read Cycle Timing

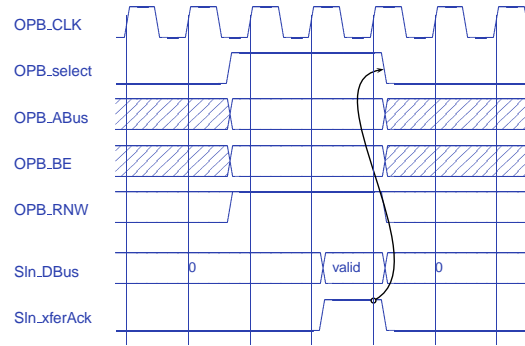

OPB signals arrive late; DBus and xferAck needed early.

The On-Chip Peripheral Bus -- p. 110

Typical OPB Write Cycle Timing

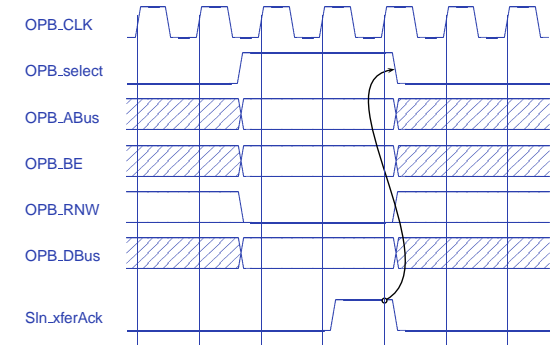

The On-Chip Peripheral Bus -- p. 123

Xilinx Rules

OPB data and address busses are 32 bits

Byte-wide peripherals use data byte 0 and word-aligned addresses (0, 4, ...)

Peripherals output 0 on everything when inactive

Xilinx does not support complete IBM OPB spec:

Dynamic bus sizing is not used

The On-Chip Peripheral Bus -- p. 130

Designing an OPB Peripheral

Let's design a peripheral that contains one of the BRAM blocks.

Reading and writing this peripheral will turn into reading and writing the BRAM.

The On-Chip Peripheral Bus -- p. 140

Block Diagram

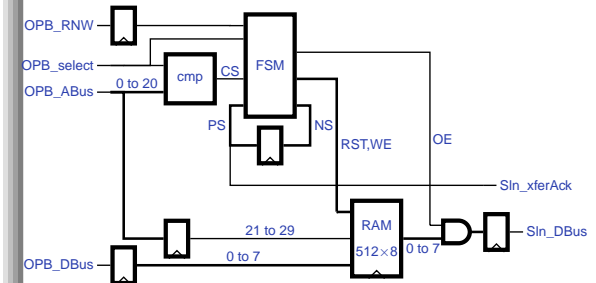

The On-Chip Peripheral Bus -- p. 150

Read Cycle

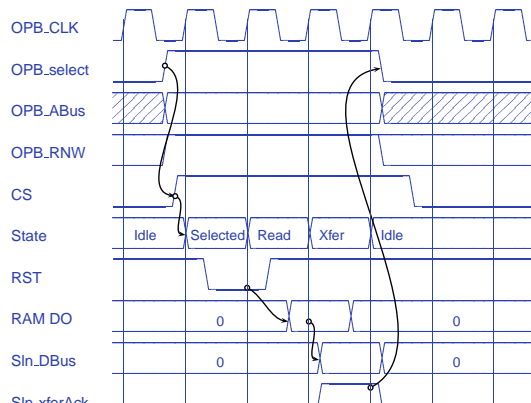

Back-to-back Read Cycles

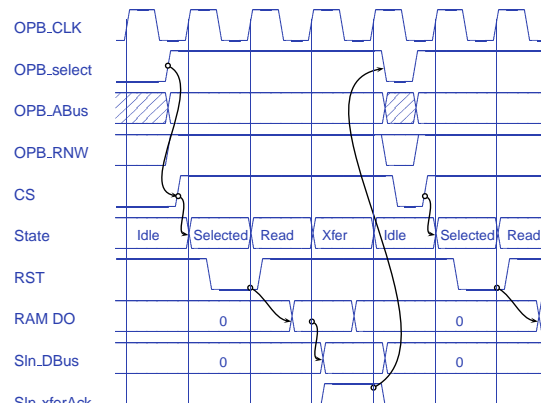

Aborted Read Cycle

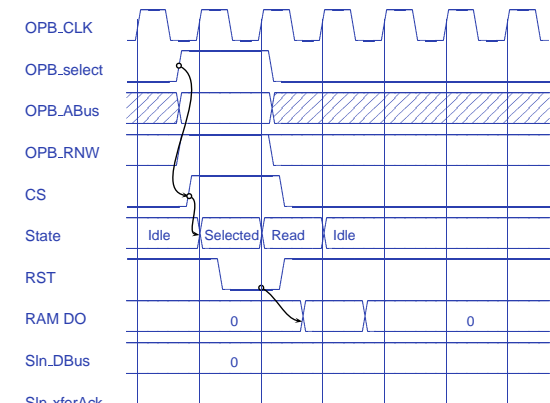

Write Cycle

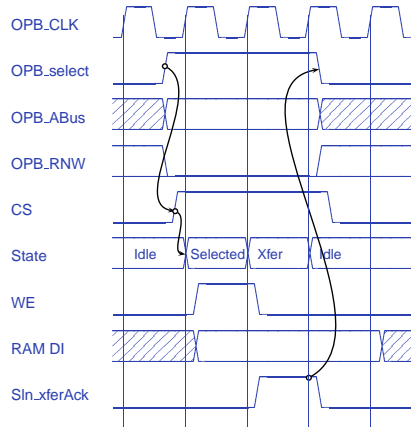

The On-Chip Peripheral Bus - p. 193

FSM

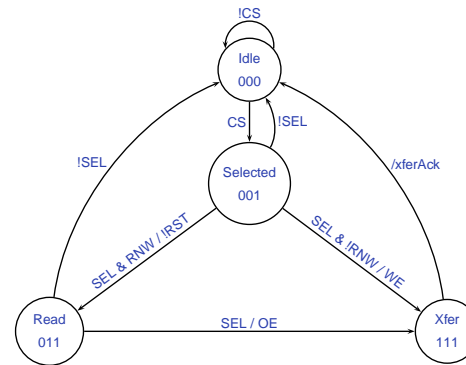

The On-Chip Peripheral Bus - p. 203

RAM component

```
signal WE, RST : std_logic;
signal RAM_DI, RAM_DO
    : std_logic_vector(0 to RAM_DWIDTH-1);
signal ABus
    : std_logic_vector(0 to RAM_AWIDTH-1);

RAMBlock : RAMB4_S8
port map (
    DO => RAM_DO,
    ADDR => ABus,
    CLK => OPB_Clk,
    DI => RAM_DI,
    EN => '1',
    RST => RST,
    WE => WE);
```

The On-Chip Peripheral Bus - p. 213

Input Registers

```
register_opb_inputs: process (OPB_Clk, OPB_Rst)
begin
    if OPB_Rst = '1' then
        RAM_DI <= (others => '0');
        ABus <= (others => '0');
        RNW <= '0';
    elsif OPB_Clk'event and OPB_Clk = '1' then
        RAM_DI <= OPB_DBus(0 to RAM_DWIDTH-1);
        ABus <=
            OPB_ABus(C_OPB_AWIDTH-3-(RAM_AWIDTH-1)
                to C_OPB_AWIDTH-3);
        RNW <= OPB_RNW;
    end if;
end process register_opb_inputs;
```

The On-Chip Peripheral Bus - p. 223

Output Registers

```
register_opb_outputs: process (OPB_Clk, OPB_Rst)
begin
    if OPB_Rst = '1' then
        Sln_DBus(0 to RAM_DWIDTH-1) <=
            (others => '0');
    elsif OPB_Clk'event and OPB_Clk = '1' then
        if output_enable = '1' then
            Sln_DBus(0 to RAM_DWIDTH-1) <=
                RAM_DO;
        else
            Sln_DBus(0 to RAM_DWIDTH-1) <=
                (others => '0');
        end if;
    end if;
end process register_opb_outputs;
```

The On-Chip Peripheral Bus - p. 233

Chip Select

```
chip_select <=
    '1' when OPB_select = '1' and
        OPB_ABus(0 to C_OPB_AWIDTH-3-RAM_AWIDTH) =
            C_BASEADDR(0 to C_OPB_AWIDTH-3-RAM_AWIDTH)
    else '0';
```

The On-Chip Peripheral Bus - p. 243

FSM: Declarations

```
constant STATE_BITS : integer := 3;
constant Idle
    : std_logic_vector(0 to STATE_BITS-1) := "000";
constant Selected
    : std_logic_vector(0 to STATE_BITS-1) := "001";
constant Read
    : std_logic_vector(0 to STATE_BITS-1) := "011";
constant Xfer
    : std_logic_vector(0 to STATE_BITS-1) := "111";

signal present_state, next_state
    : std_logic_vector(0 to STATE_BITS-1);
```

FSM: Sequential

```
fsm_seq : process(OPB_Clk, OPB_Rst)
begin
    if OPB_Rst = '1' then
        current_state <= Idle;
    elsif OPB_Clk'event and OPB_Clk = '1' then
        current_state <= next_state;
    end if;
end process fsm_seq;
```

FSM: Combinational

```
fsm_comb : process(OPB_Rst, present_state,
    chip_select, OPB_Select, RNW)
begin
    RST <= '1';
    WE <= '0';
    output_enable <= '0';
    if OPB_RST = '1' then
        next_state <= Idle;
    else
        case present_state is
            when Idle =>
                if chip_select = '1' then
                    next_state <= Selected;
                else
                    next_state <= Idle;
                end if;
        end case;
    end if;
```

FSM: Combinational

```
when Selected =>
  if OPB_Select = '1' then
    if RNW = '1' then
      RST <= '0';
      next_state <= Read;
    else
      WE <= '1';
      next_state <= Xfer;
    end if;
  else
    next_state <= Idle;
  end if;

when Read =>
  if OPB_Select = '1' then
    output_enable <= '1';
    next_state <= Xfer;
  else
    next_state <= Idle;
  end if;
```

FSM: Combinational

```
-- State encoding is critical here:
-- xfer must only be true here
when Xfer =>
  next_state <= Idle;

when others =>
  next_state <= Idle;
end case;
end if;
end process fsm_comb;
```

For more information...

[Xilinx Processor IP Reference Guide](#)

[IBM On-Chip Peripheral Bus Architecture Specification](#)