

Fundamentals of Computer Systems

Finite State Machines

Stephen A. Edwards

Columbia University

Summer 2021

Finite State Machine Components

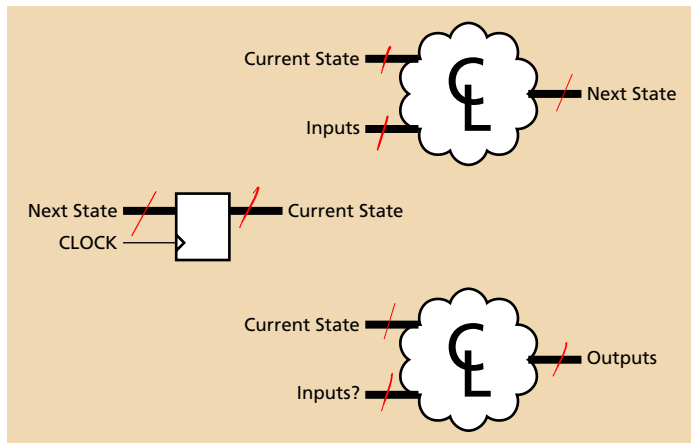

Moore and Mealy Machines

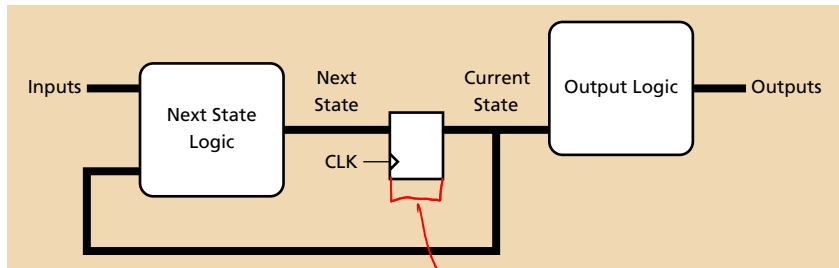

The Moore Form:

More flip-flops

Outputs are a function of **only** the current state.

Moore and Mealy Machines

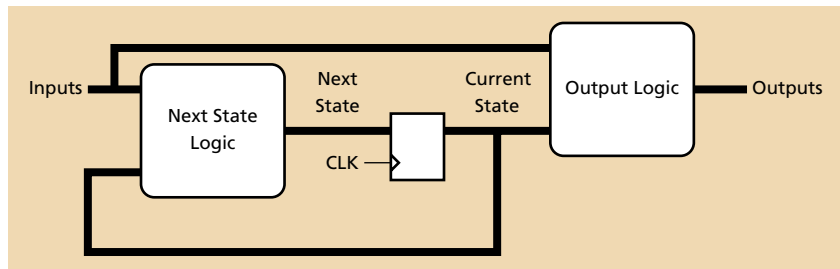

The Mealy Form:

Outputs may be a function of *both* the current state and the inputs.

A mnemonic: Moore machines often have more states.

Mealy Machines are the Most General

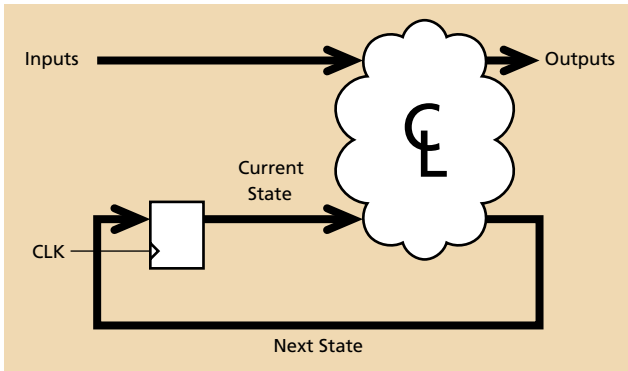

Another, equivalent way of drawing Mealy Machines

This is exactly the synchronous digital logic paradigm

Moore vs. Mealy FSMs

Alyssa P. Hacker has a snail that crawls down a paper tape with 1's and 0's on it. The snail smiles whenever the last four digits it has crawled over are 1101. Design Moore and Mealy FSMs of the snail's brain.



State Transition Diagrams: Looking for "1101"

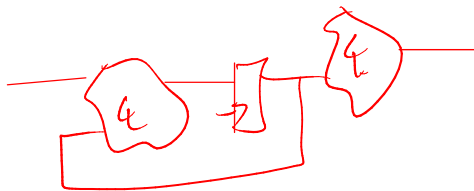
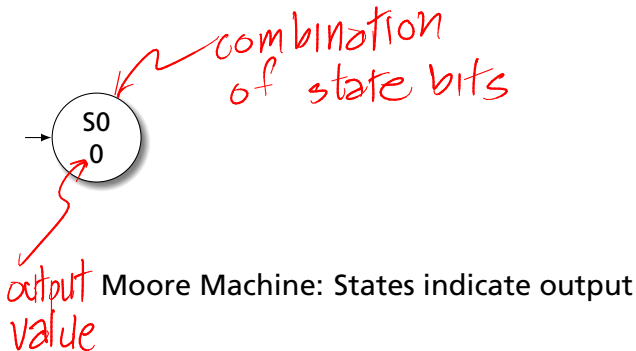

State Transition Diagrams: Looking for "1101"

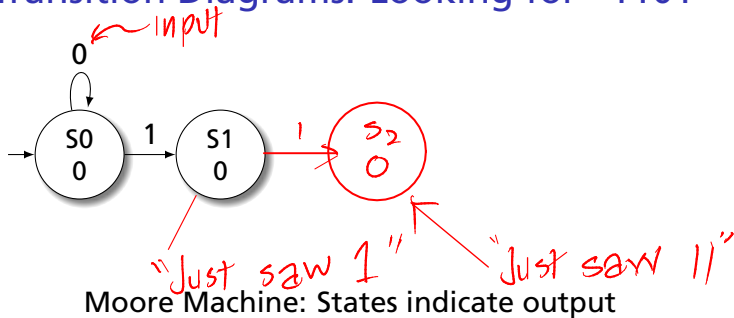

State Transition Diagrams: Looking for "1101"

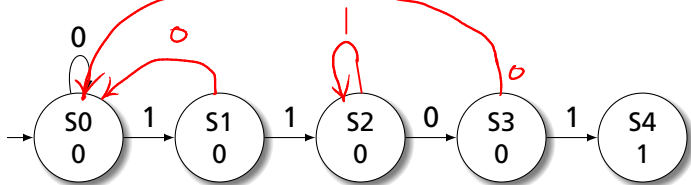

Moore Machine: States indicate output

"just saw 1" *"just saw 11"*

"just saw 1101"

State Transition Diagrams: Looking for "1101"

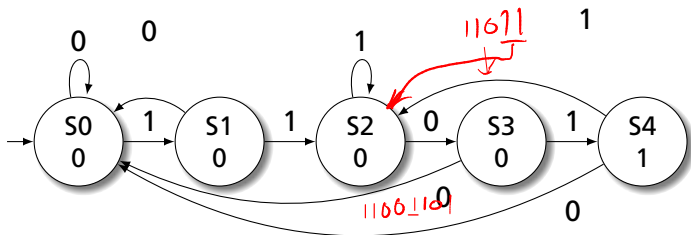

Moore Machine: States indicate output

11011011011011 repeat every 3 symbols

State Transition Diagrams: Looking for "1101"

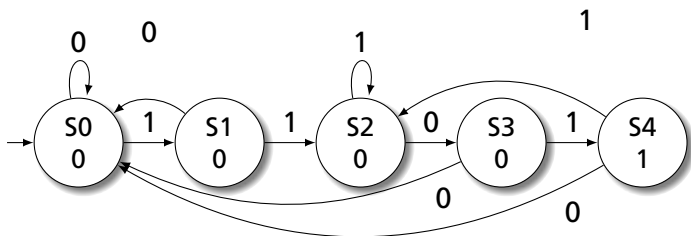

Moore Machine: States indicate output

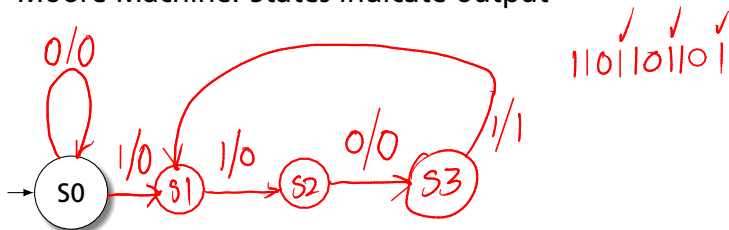

Mealy Machine: Arcs indicate input/output

State Transition Diagrams: Looking for "1101"

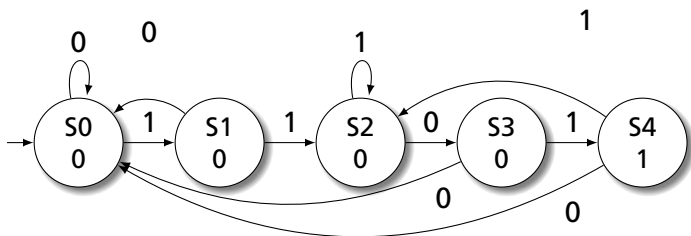

Moore Machine: States indicate output

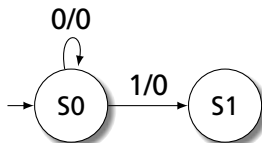

Mealy Machine: Arcs indicate input/output

State Transition Diagrams: Looking for "1101"

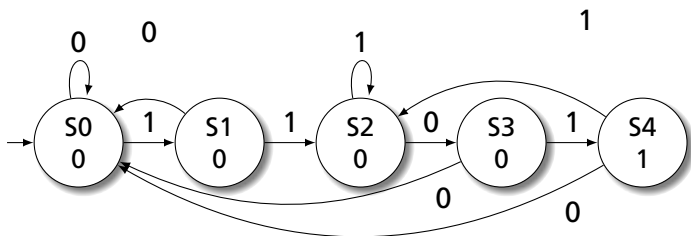

Moore Machine: States indicate output

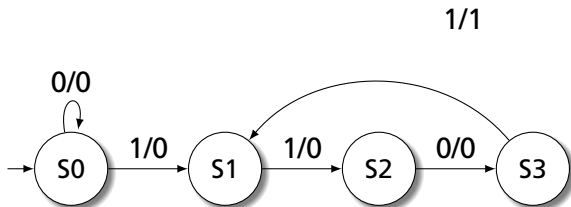

State Transition Diagrams: Looking for "1101"

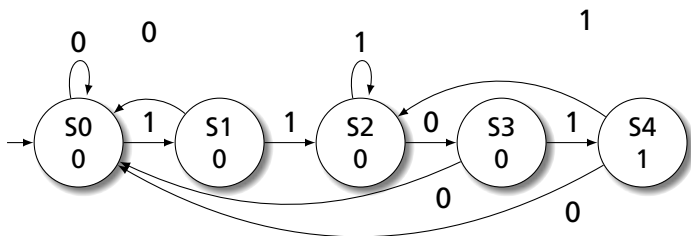

5 states

Moore Machine: States indicate output

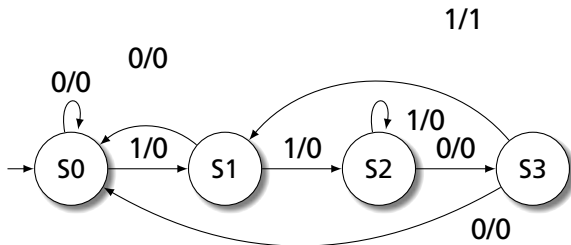

4 states

Moore Machine



Next State			Output	
S	A	S'	S	Y
S0	0	S0	S0	0
S0	1	S1	S1	0
S1	0	S0	S2	0
S1	1	S2	S3	0
S2	0	S3	S4	1
S2	1	S2		
S3	0	S0		
S3	1	S4		
S4	0	S0		
S4	1	S2		

Moore Machine

s_2

0000
0100
x x x x
0 0 x x

input to next-state logic
next state functions

Next State			Output	
S	A	S'	S	Y
000	0	000	000	0
000	1	001	001	0
001	0	000	010	0
001	1	010	011	0
010	0	011	100	1
010	1	010		
011	0	000	101	X
011	1	100	110	X
100	0	000	111	X
100	1	010		

$\begin{matrix} 111 \\ 210 \end{matrix}$
 $\begin{matrix} 111 \\ 210 \end{matrix}$
 $\begin{matrix} 101 & X & X & X \\ 110 & X & X & X \\ 111 & X & X & X \end{matrix}$

D FFs
state bits

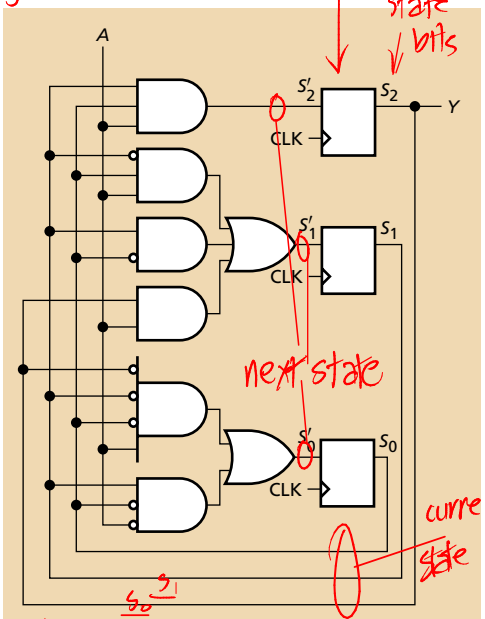

next state

current state

$$Y = \begin{matrix} 0000 \\ s_1 (1xxx) \end{matrix} = S_2$$

Mealy Machine

S	A	S'	Y
S0	0	S0	0
S0	1	S1	0
S1	0	S0	0
S1	1	S2	0
S2	0	S3	0
S2	1	S2	0
S3	0	S0	0
S3	1	S1	1

Mealy Machine

S	A	S'	Y
00	0	00	0
00	1	01	0
01	0	00	0
01	1	10	0
10	0	11	0
10	1	10	0
11	0	00	0
11	1	01	1

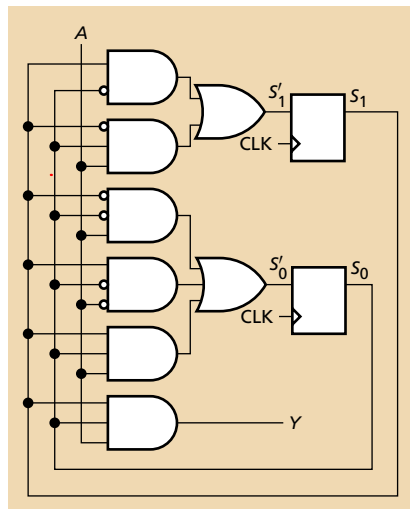

More Intuitive Solutions using Shift Registers

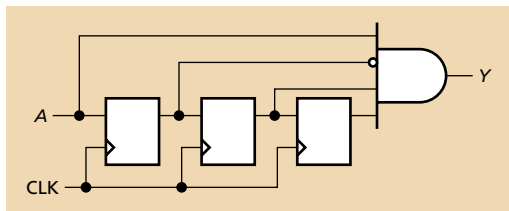

Mealy Form: Output Depends on Input Immediately

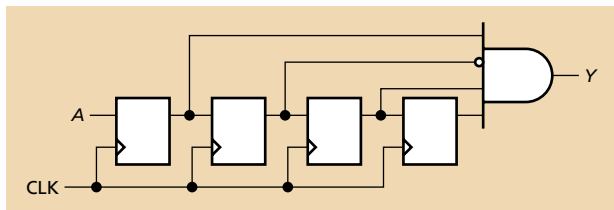

Moore Form: Output Depends Only on State

FSM Example: A Traffic Light Controller

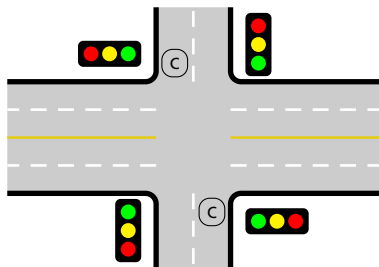

This controls a traffic light at the intersection of a busy highway and a farm road. Normally, the highway light is green but if a sensor detects a car on the farm road, the highway light turns yellow

then red. The farm road light then turns green until there are no cars or after a long timeout. Then, the farm road light turns yellow then red, and the highway light returns to green. The inputs to the machine are the car sensor, a short timeout signal, and a long timeout signal. The outputs are a timer start signal and the colors of the highway and farm road lights.

State Transition Diagram for the TLC

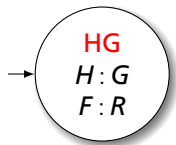

Inputs:

C: Car sensor

S: Short Timeout

L: Long Timeout

Outputs:

T: Timer Reset

H: Highway color

F: Farm road color

State Transition Diagram for the TLC

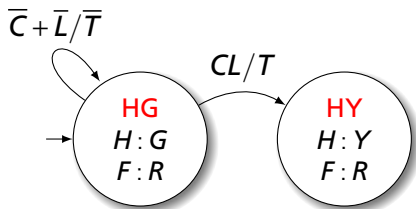

Inputs:

C: Car sensor

S: Short Timeout

L: Long Timeout

Outputs:

T: Timer Reset

H: Highway color

F: Farm road color

State Transition Diagram for the TLC

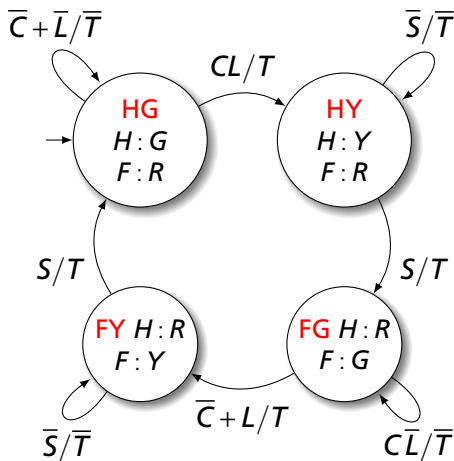

Inputs:

C: Car sensor

S: Short Timeout

L: Long Timeout

Outputs:

T: Timer Reset

H: Highway color

F: Farm road color

State Transition Diagram for the TLC

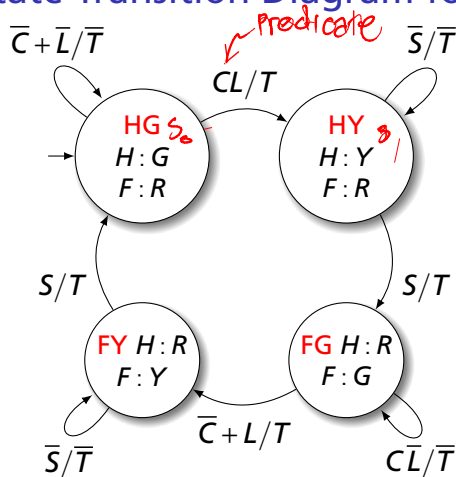

S	C	S	L	T	S'
HG	0	X	X	0	HG
HG	X	X	0	0	HG
HG	1	X	1	1	HY
HY	X	0	X	0	HY
HY	X	1	X	1	FG
FG	1	X	0	0	FG
FG	0	X	X	1	FY
FG	X	X	1	1	FY
FY	X	0	X	0	FY
FY	X	1	X	1	HG

S	H	F
HG	G	R
HY	Y	R
FG	R	G
FY	R	Y

Inputs:

C: Car sensor

S: Short Timeout

L: Long Timeout

Outputs:

T: Timer Reset

H: Highway color

F: Farm road color

State and Output Encoding

S	C	S	L	T	S'
HG	0	X	X	0	HG
HG	X	X	0	0	HG
HG	1	X	1	1	HY
HY	X	0	X	0	HY
HY	X	1	X	1	FG
FG	1	X	0	0	FG
FG	0	X	X	1	FY
FG	X	X	1	1	FY
FY	X	0	X	0	FY
FY	X	1	X	1	HG

S	H	F
HG	G	R
HY	Y	R
FG	R	G
FY	R	Y

First idea: use a binary encoding:

HG	00
HY	01
FG	10
FY	11

G	00
Y	01
R	10

State and Output Encoding

S	C	S	L	T	S'
00	0	X	X	0	00
00	X	X	0	0	00
00	1	X	1	1	01
01	X	0	X	0	01
01	X	1	X	1	10
10	1	X	0	0	10
10	0	X	X	1	11
10	X	X	1	1	11
11	X	0	X	0	11
11	X	1	X	1	00

S	H	F
00	00	10
01	01	10
10	10	00
11	10	01

$$T = \overline{S_1} \overline{S_0} CL + \overline{S_1} S_0 S + S_1 \overline{S_0} (\overline{C} + L) + S_1 S_0 S$$

$$S'_1 = \overline{S_1} S_0 S + S_1 \overline{S_0} + S_1 S_0 S$$

$$S'_0 = \overline{S_1} \overline{S_0} CL + \overline{S_1} S_0 \overline{S} + S_1 \overline{S_0} (\overline{C} + L) + S_1 S_0 \overline{S}$$

$$H_1 = S_1$$

$$H_0 = \overline{S_1} S_0$$

$$F_1 = \overline{S_1}$$

$$F_0 = S_1 S_0$$

State and Output Encoding

S	C	S	L	T	S'
00	0	X	X	0	00
00	X	X	0	0	00
00	1	X	1	1	01
01	X	0	X	0	01
01	X	1	X	1	10
10	1	X	0	0	10
10	0	X	X	1	11
10	X	X	1	1	11
11	X	0	X	0	11
11	X	1	X	1	00

S	H	F
00	00	10
01	01	10
10	10	00
11	10	01

$$T = \overline{S_1} \overline{S_0} CL + S_0 S + S_1 \overline{S_0} (\overline{C} + L)$$

$$S'_1 = S_0 S + S_1 \overline{S_0}$$

$$S'_0 = \overline{S_1} \overline{S_0} CL + S_0 \overline{S} + S_1 \overline{S_0} (\overline{C} + L)$$

$$H_1 = S_1$$

$$H_0 = \overline{S_1} S_0$$

$$F_1 = \overline{S_1}$$

$$F_0 = S_1 S_0$$

State and Output Encoding

S	C	S	L	T	S'
00	0	X	X	0	00
00	X	X	0	0	00
00	1	X	1	1	01
01	X	0	X	0	01
01	X	1	X	1	10
10	1	X	0	0	10
10	0	X	X	1	11
10	X	X	1	1	11
11	X	0	X	0	11
11	X	1	X	1	00

S	H	F
00	00	10
01	01	10
10	10	00
11	10	01

$$T = \overline{S_0}(\overline{S_1}CL + S_1(\overline{C} + L)) + S_0S$$

$$S'_1 = S_0S + S_1\overline{S_0}$$

$$S'_0 = \overline{S_0}(\overline{S_1}CL + S_1(\overline{C} + L)) + S_0\overline{S}$$

$$H_1 = S_1$$

$$H_0 = \overline{S_1}S_0$$

$$F_1 = \overline{S_1}$$

$$F_0 = S_1S_0$$

State and Output Encoding

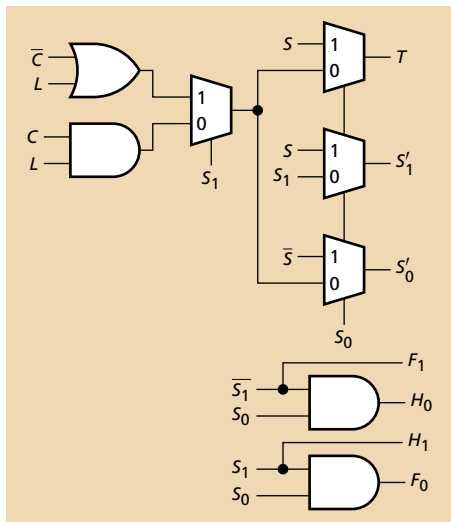

$$T = \bar{S}_0(\bar{S}_1 CL + S_1(\bar{C} + L)) + S_0 S$$

$$S'_1 = S_0 S + S_1 \bar{S}_0$$

$$S'_0 = \bar{S}_0(\bar{S}_1 CL + S_1(\bar{C} + L)) + S_0 \bar{S}$$

$$H_1 = S_1$$

$$H_0 = \bar{S}_1 S_0$$

$$F_1 = \bar{S}_1$$

$$F_0 = S_1 S_0$$

State and Output Encoding

S	C	S	L	T	S'
HG	0	X	X	0	HG
HG	X	X	0	0	HG
HG	1	X	1	1	HY
HY	X	0	X	0	HY
HY	X	1	X	1	FG
FG	1	X	0	0	FG
FG	0	X	X	1	FY
FG	X	X	1	1	FY
FY	X	0	X	0	FY
FY	X	1	X	1	HG

S	H	F
HG	G	R
HY	Y	R
FG	R	G
FY	R	Y

Second idea: use a one-hot encoding:

HG	0001	G	001
HY	0010	Y	010
FG	0100	R	100
FY	1000		

one-hot encoding
one FF state:
in that state that FF = 1

State and Output Encoding

S	C	S	L	T	S'
0001	0	X	X	0	0001
0001	X	X	0	0	0001
0001	1	X	1	1	0010
0010	X	0	X	0	0010
0010	X	1	X	1	0100
0100	1	X	0	0	0100
0100	0	X	X	1	1000
0100	X	X	1	1	1000
1000	X	0	X	0	1000
1000	X	1	X	1	0001

S	H	F
0001	001	100
0010	010	100
0100	100	001
1000	100	010

$$T = S_0CL + S_1S + S_2(\bar{C} + L) + S_3S$$

$$S'_3 = S_2(\bar{C} + L) + S_3\bar{S}$$

$$S'_2 = S_1S + S_2(\bar{C} + L)$$

$$S'_1 = S_0CL + S_1\bar{S}$$

$$S'_0 = S_0(\bar{C}L) + S_3S$$

$$H_R = S_2 + S_3$$

$$H_Y = S_1$$

$$H_G = S_0$$

$$F_R = S_0 + S_1$$

$$F_Y = S_3$$

$$F_G = S_2$$

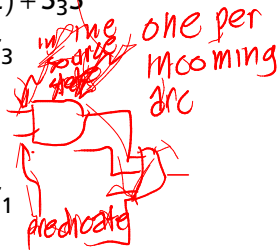

State and Output Encoding

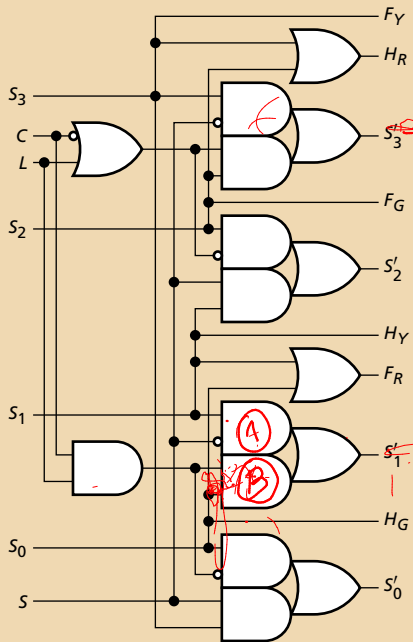

$$T = S_0CL + S_1S + S_2(\bar{C} + L) + S_3S$$

$$S'_3 = S_2(\bar{C} + L) + S_3\bar{S}$$

$$S'_2 = S_1S + S_2\overline{(\bar{C} + L)}$$

$$S'_1 = S_0CL + S_1\bar{S}$$

$$S'_0 = S_0\overline{(CL)} + S_3S$$

$$H_R = S_2 + S_3$$

$$H_Y = S_1$$

$$H_G = S_0$$

$$F_R = S_0 + S_1$$

$$F_Y = S_3$$

$$F_G = S_2$$

