

Fundamentals of Computer Systems

Memory

Stephen A. Edwards

Columbia University

Summer 2020

Atari Space Race, 1973

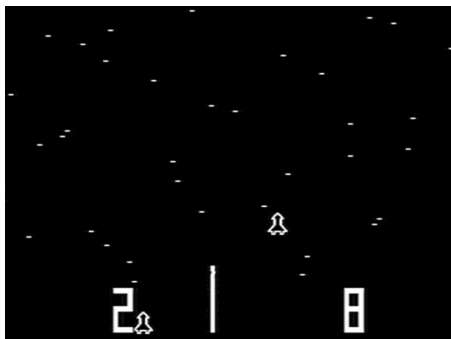
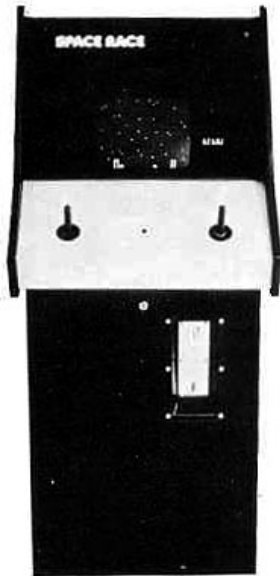

Atari Space Race PCB

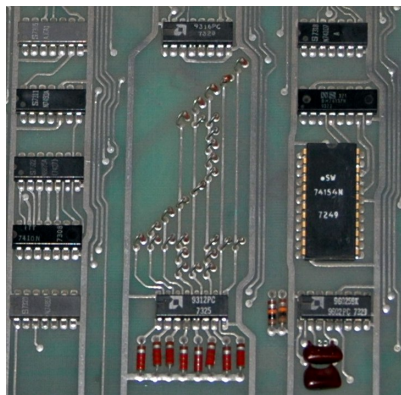

Front

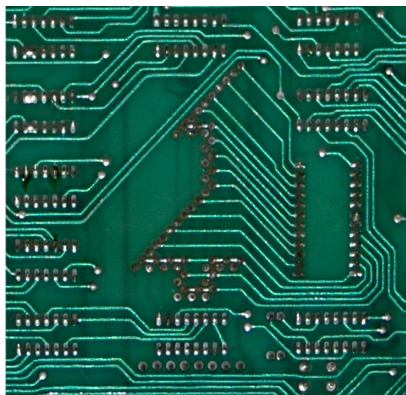

Back (mirrored)

Read-Only Memories: Combinational Functions

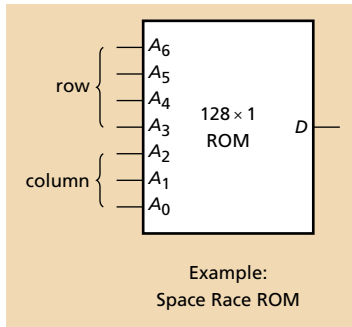
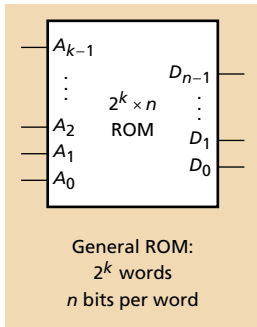

Implementing ROMs

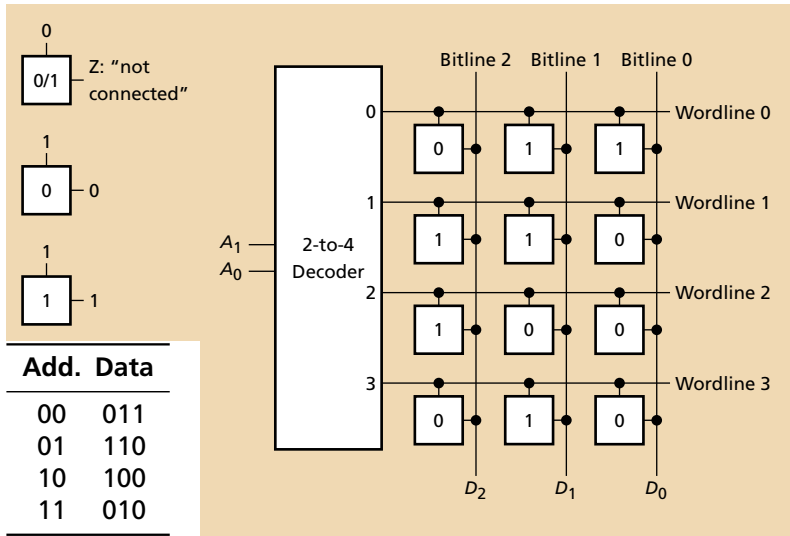

Implementing ROMs

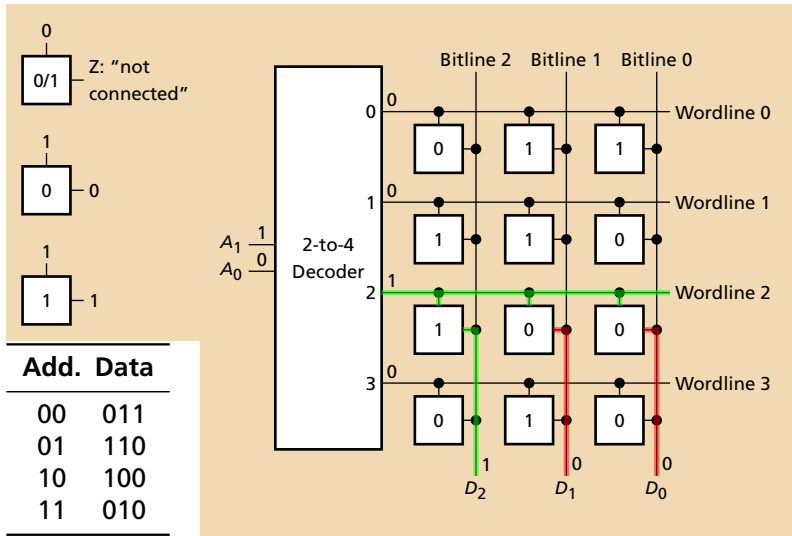

Implementing ROMs

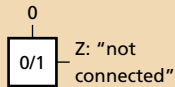

Addr. Data

00	011
01	110
10	100
11	010

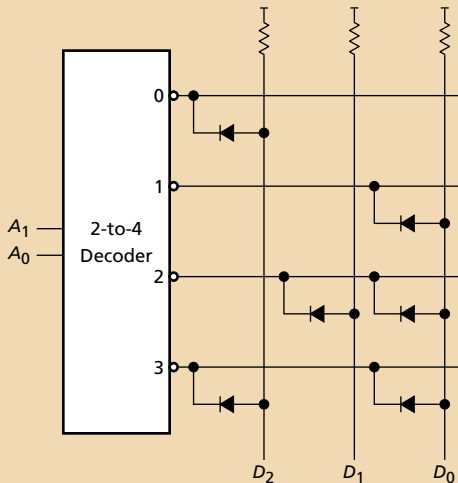

Implementing ROMs

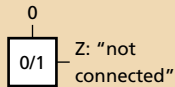

Add. Data

00	011
01	110
10	100
11	010

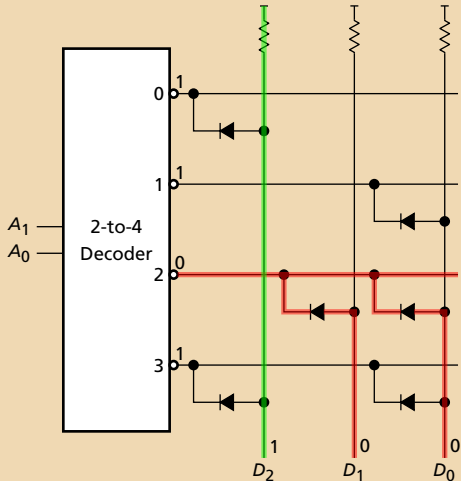

Atari Space Race Schematic

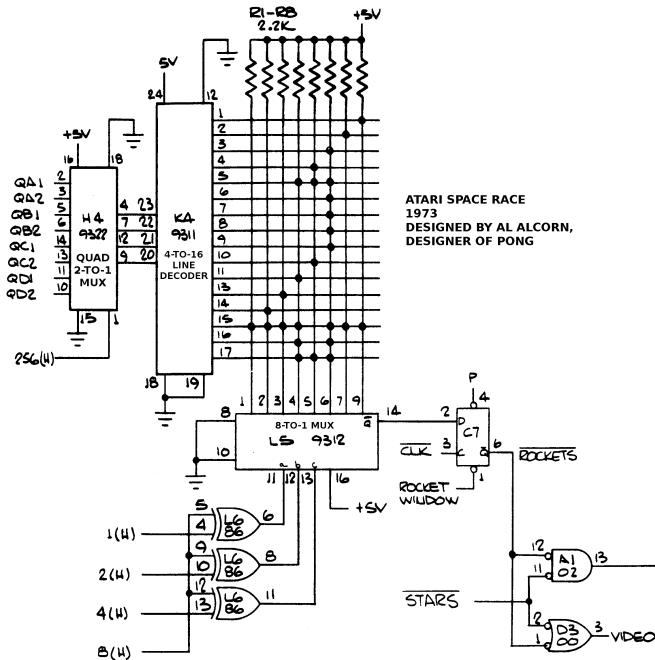

The 1971 DEC M792-YB Bootstrap Diode Matrix

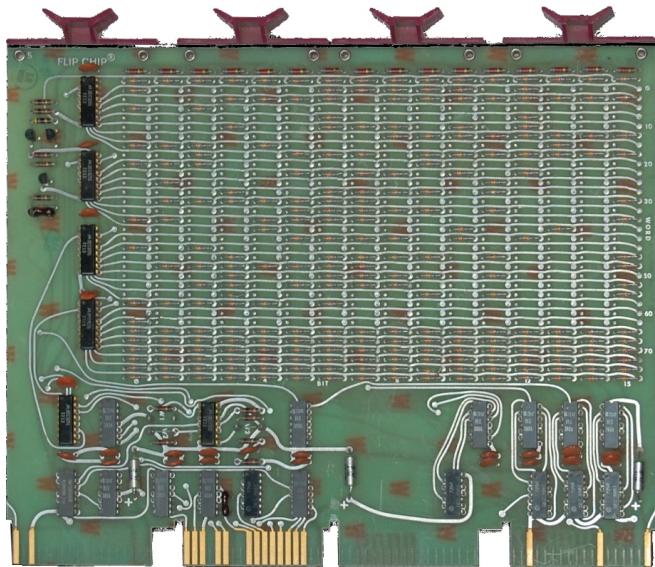

32-word, 16-bit (64-byte) ROM diode matrix

CMOS Mask-Programmed ROMs

Add. Data	
00	011
01	110
10	100
11	010

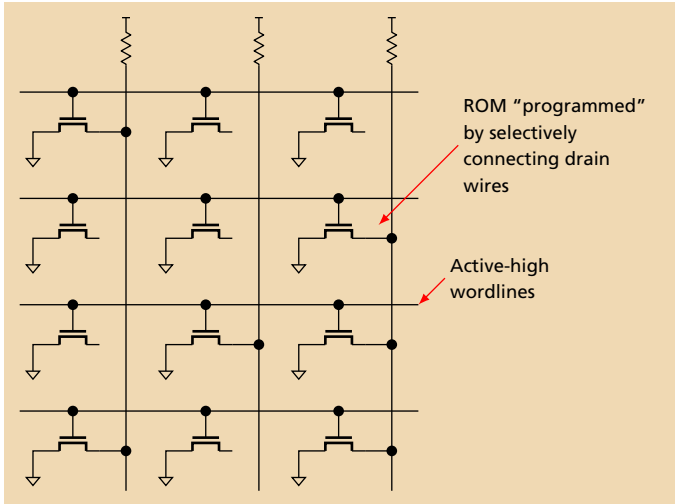

Mask ROM Die Photo

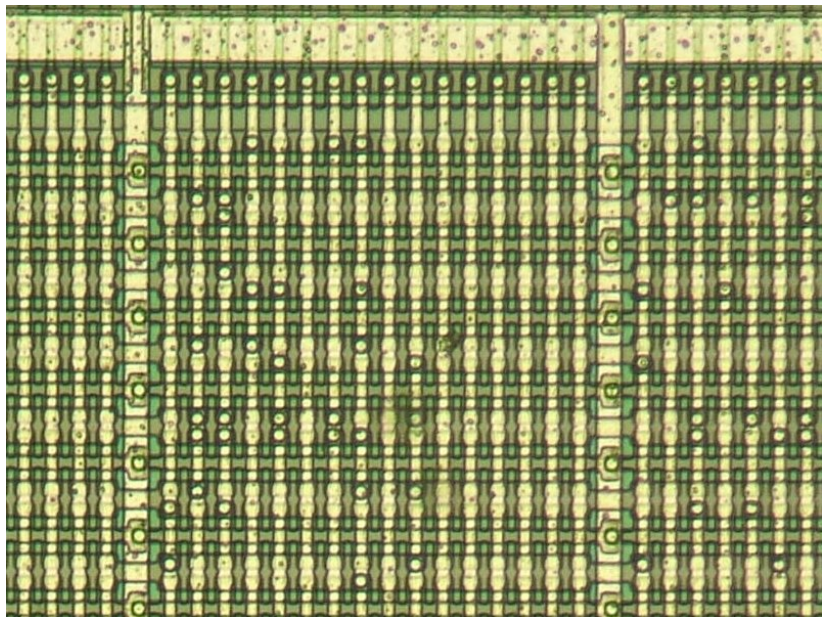

Color PROM in Pac-Man

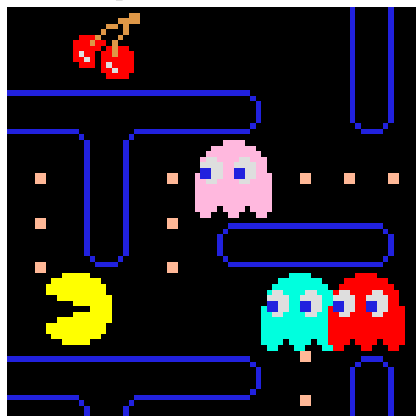
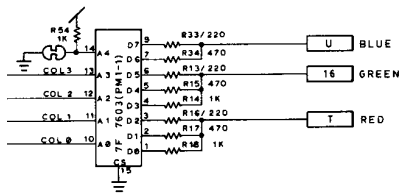

00	00	█
01	07	█
02	66	█
03	EF	█
04	00	█
05	F8	█
06	EA	█
07	6F	█
08	00	█
09	3F	█
0A	00	█
0B	C9	█
0C	38	█
0D	AA	█
0E	AF	█
0F	F6	█
10	00	█
⋮	⋮	
1F	00	█

A Floating Gate MOSFET

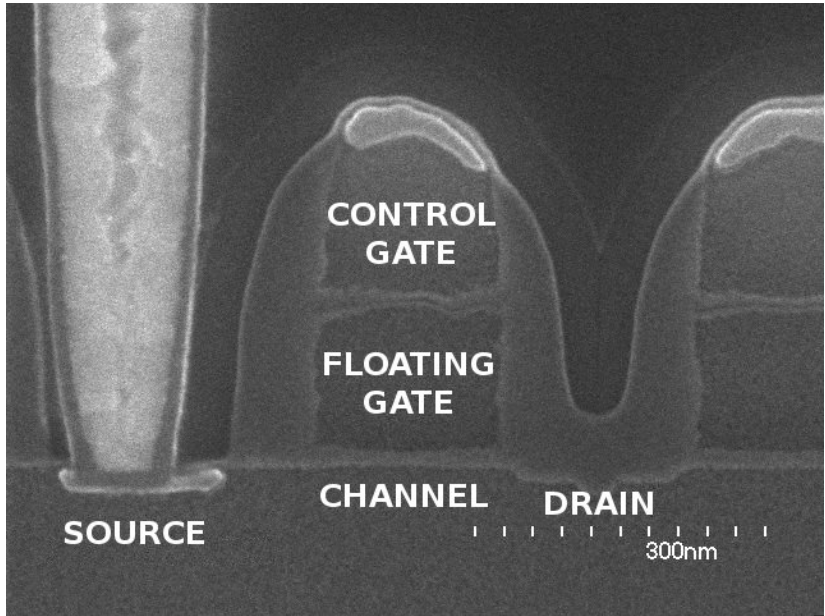

Cross section of a NOR FLASH transistor. Kawai et al., ISSCC 2008 (Renesas)

Floating Gate n-channel MOSFET

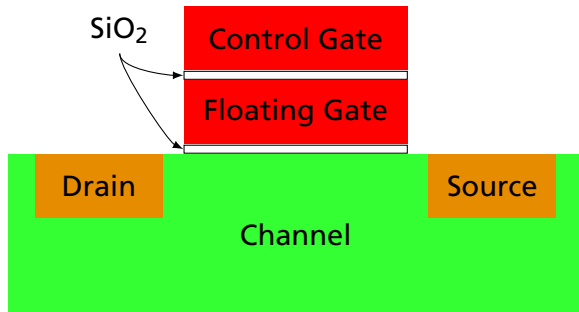

Floating gate uncharged; Control gate at 0V: Off

Floating Gate n-channel MOSFET

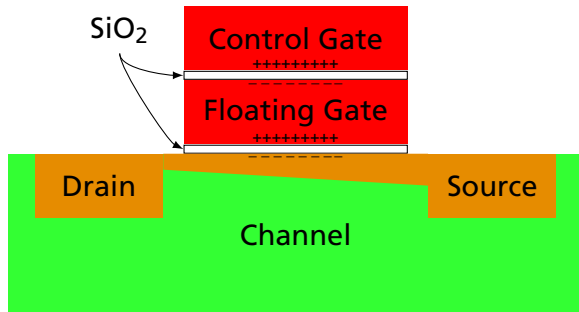

Floating gate uncharged; Control gate positive: On

Floating Gate n-channel MOSFET

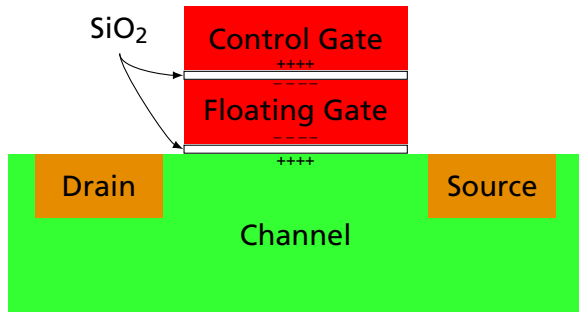

Floating gate negative; Control gate at 0V: Off

Floating Gate n-channel MOSFET

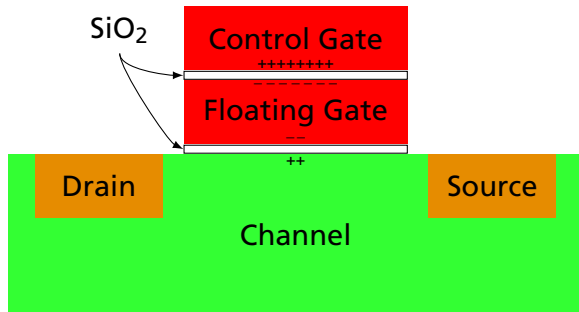

Floating gate negative; Control gate positive: Off

EPROMs and FLASH use Floating-Gate MOSFETs

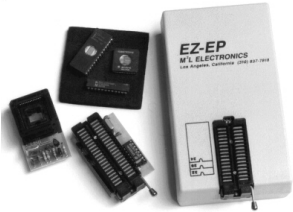
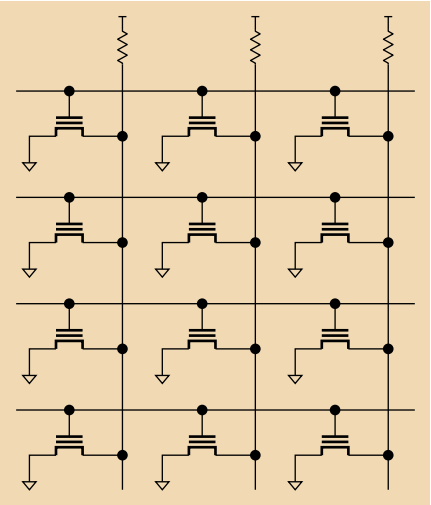

Static Random-Access Memory Cell

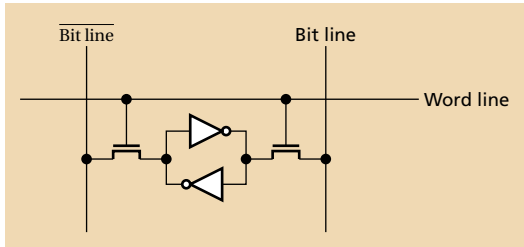

Layout of a 6T SRAM Cell

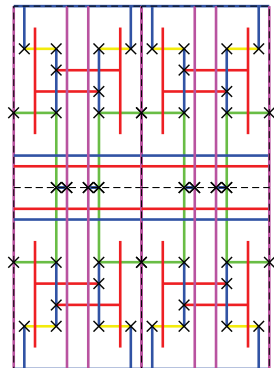
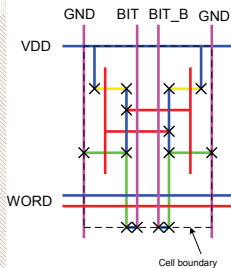
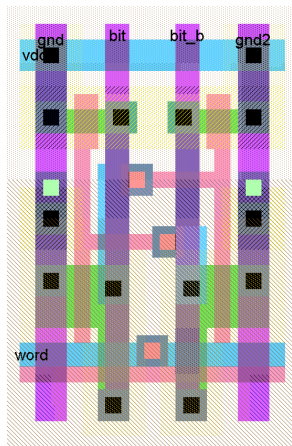

Weste and Harris. *Introduction to CMOS VLSI Design*. Addison-Wesley, 2010.

Intel's 2102 SRAM, 1024 × 1 bit, 1972

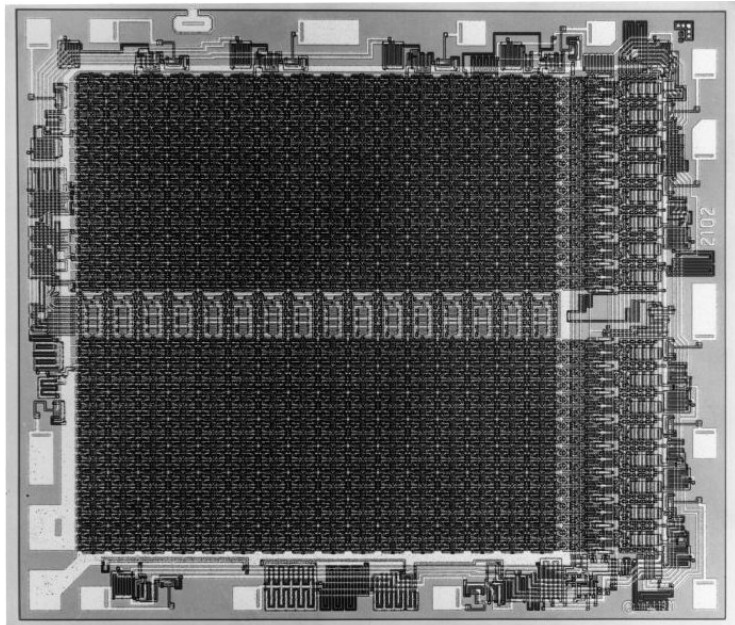

2102 Block Diagram

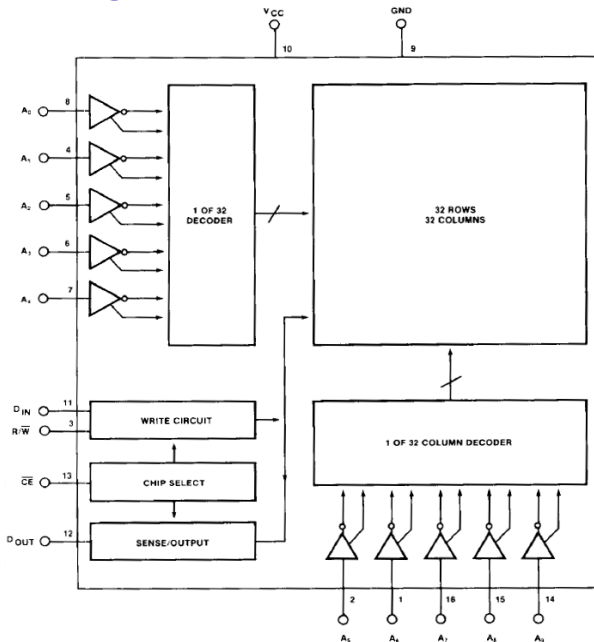

SRAM Timing

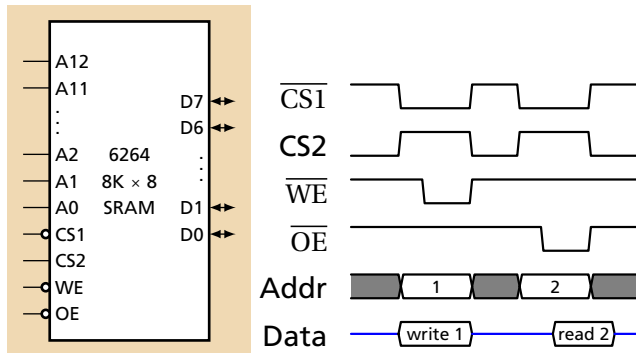

6264 SRAM Block Diagram

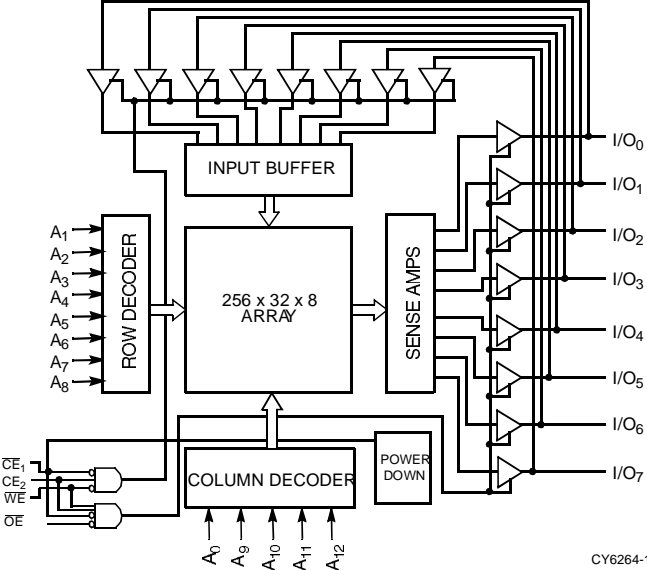

Dynamic RAM Cell

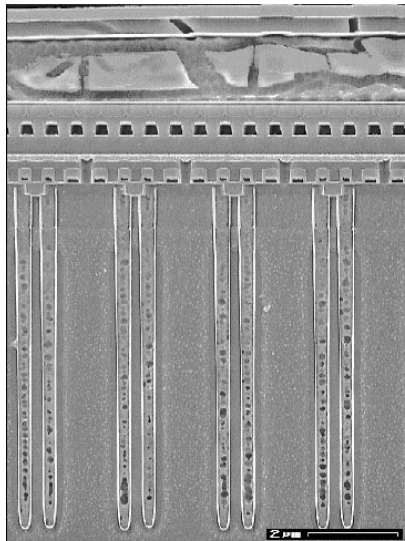
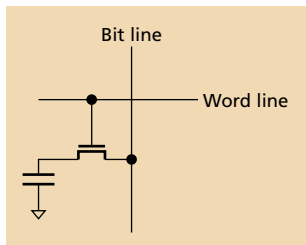

Our Old Pal, the Space Race ROM

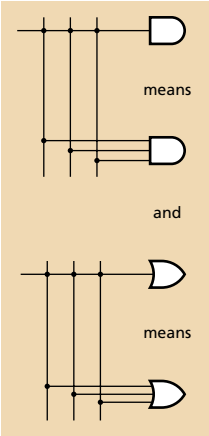
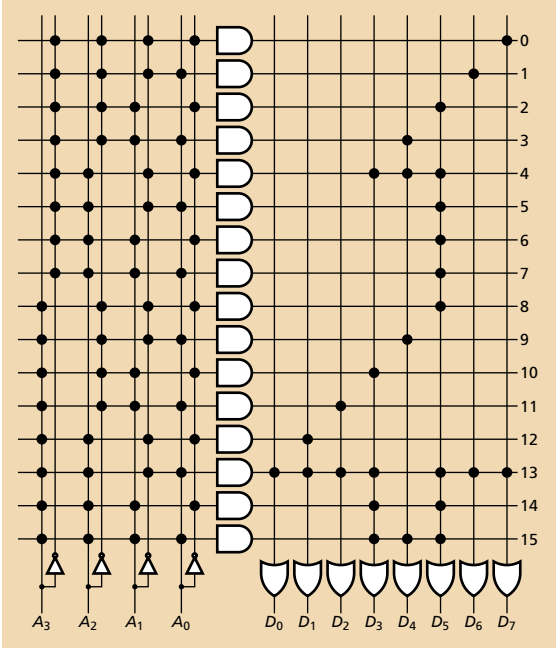

Our Old Pal, the Space Race ROM

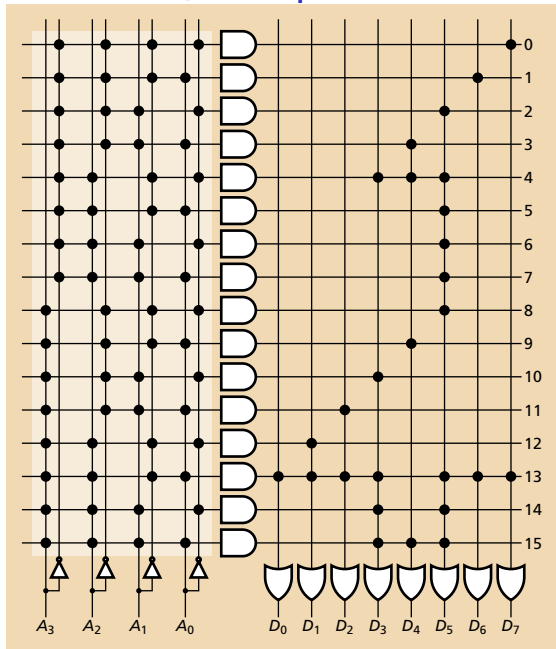

The decoder or
"AND plane"

In a RAM or ROM,
computes every
minterm

Pattern is not
programmable

Our Old Pal, the Space Race ROM

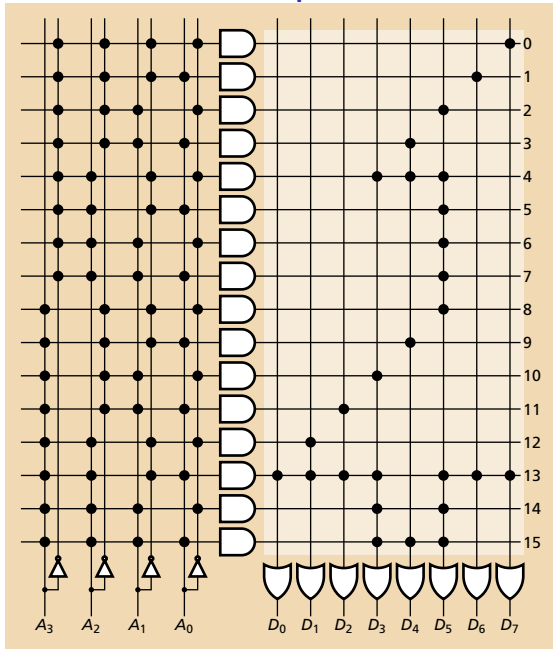

The decoder or “OR plane”

One term for every output

Pattern is programmable = the contents of the ROM

Our Old Pal, the Space Race ROM

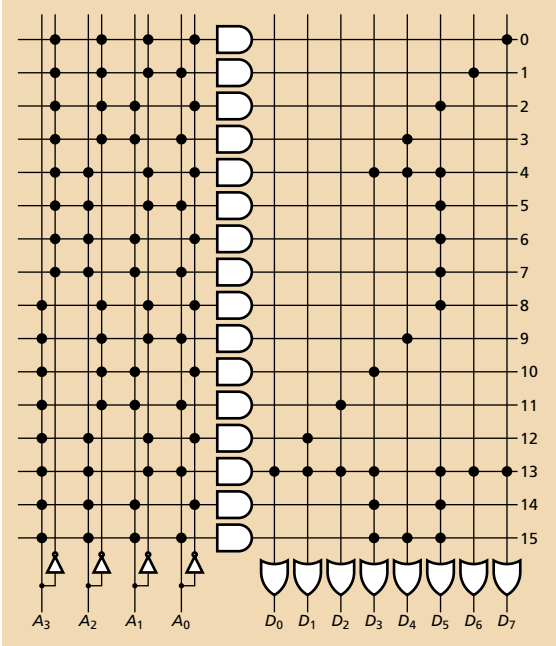

Can we do better?

Simplifying the Space Race ROM

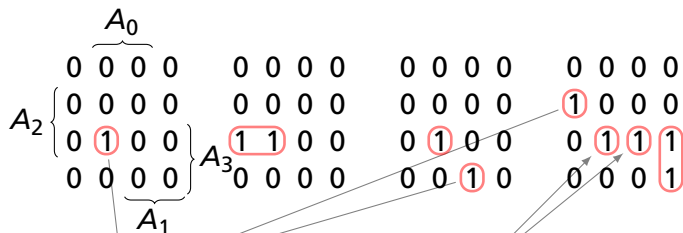

Essential minterms

mean don't expand these



Our New PAL, the Space Race ROM

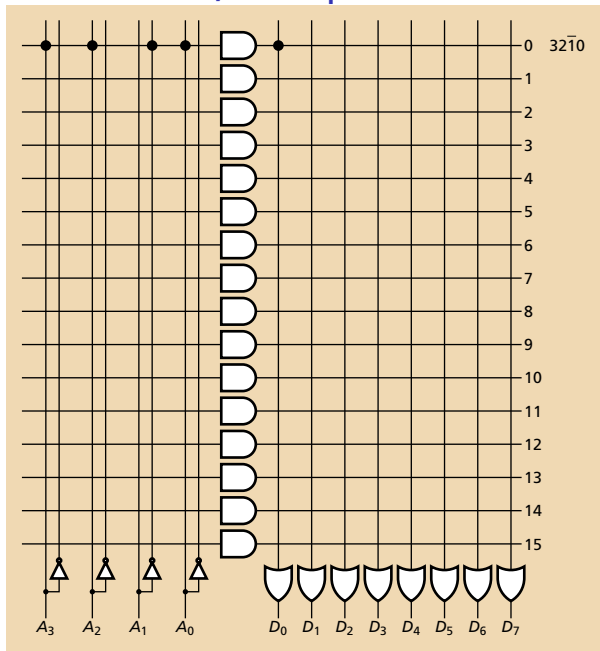

$$D_0 = 32\bar{1}0$$

Our New PAL, the Space Race ROM

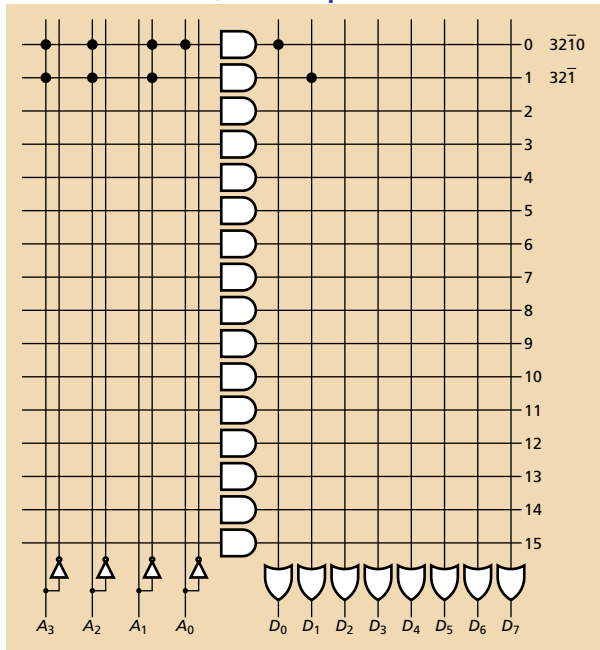

$$D_0 = 32\bar{1}0$$

$$D_1 = 32\bar{1}$$

Our New PAL, the Space Race ROM

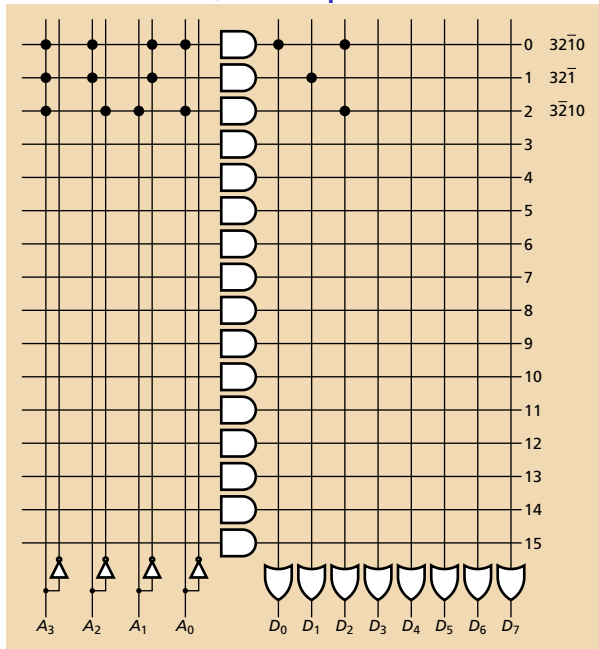

$$D_0 = 3\bar{2}10$$

$$D_1 = 3\bar{2}1$$

$$D_2 = 3\bar{2}10 + 3\bar{2}10$$

Our New PAL, the Space Race ROM

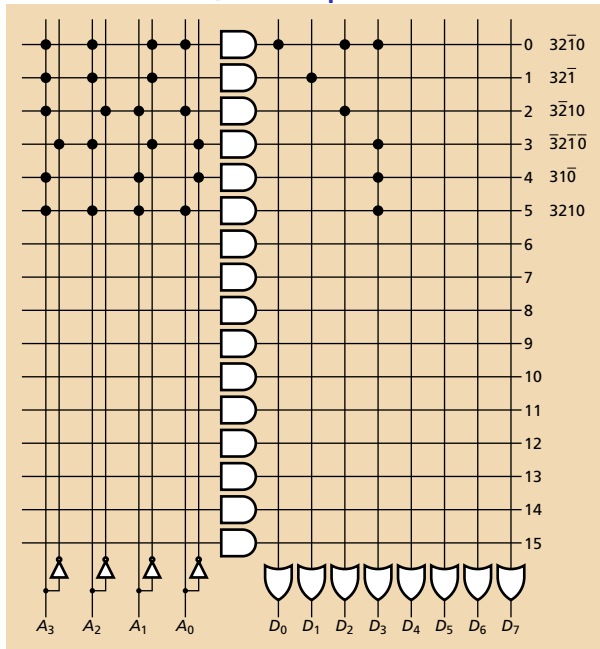

$$D_0 = 3\bar{2}\bar{1}0$$

$$D_1 = 3\bar{2}\bar{1}$$

$$D_2 = 3\bar{2}\bar{1}0 + 3\bar{2}\bar{1}0$$

$$D_3 = \bar{3}\bar{2}\bar{1}\bar{0} + 3\bar{1}\bar{0} + 3\bar{2}\bar{1}0 + 32\bar{1}0$$

Our New PAL, the Space Race ROM

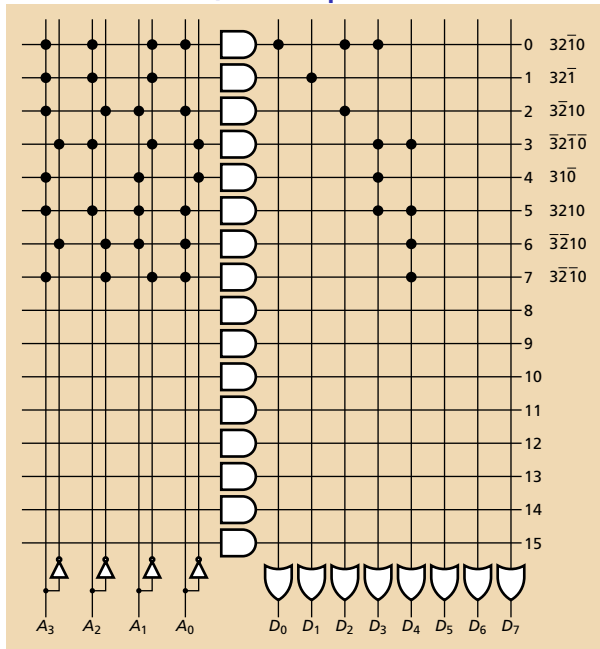

$$D_0 = 3\bar{2}\bar{1}0$$

$$D_1 = 3\bar{2}\bar{1}$$

$$D_2 = \bar{3}\bar{2}\bar{1}0 + 31\bar{0}$$

$$D_3 = \bar{3}\bar{2}\bar{1}0 + 31\bar{0} + 3\bar{2}\bar{1}0 + 3210$$

$$D_4 = \bar{3}\bar{2}\bar{1}0 + \bar{3}\bar{2}10 + 3\bar{2}\bar{1}0 + 3210$$

Our New PAL, the Space Race ROM

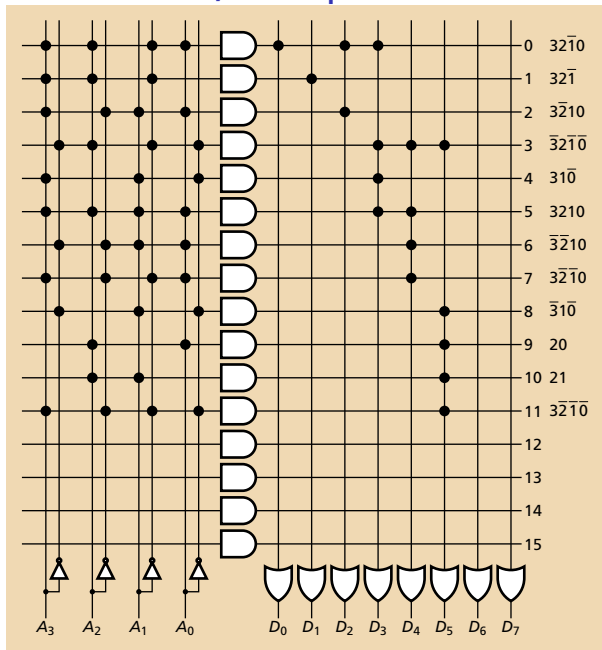

$$D_0 = 3\bar{2}\bar{1}0$$

$$D_1 = 3\bar{2}\bar{1}$$

$$D_2 = \bar{3}\bar{2}\bar{1}0 + 3\bar{2}\bar{1}0$$

$$D_3 = \bar{3}\bar{2}\bar{1}0 + 3\bar{1}0 + \bar{3}\bar{2}\bar{1}0 + 3\bar{2}\bar{1}0$$

$$D_4 = \bar{3}\bar{2}\bar{1}0 + \bar{3}\bar{2}\bar{1}0 + \bar{3}\bar{2}\bar{1}0 + 3\bar{2}\bar{1}0$$

$$D_5 = \bar{3}\bar{1}0 + 20 + 21 + \bar{3}\bar{2}\bar{1}0 + \bar{3}\bar{2}\bar{1}0$$

Our New PAL, the Space Race ROM

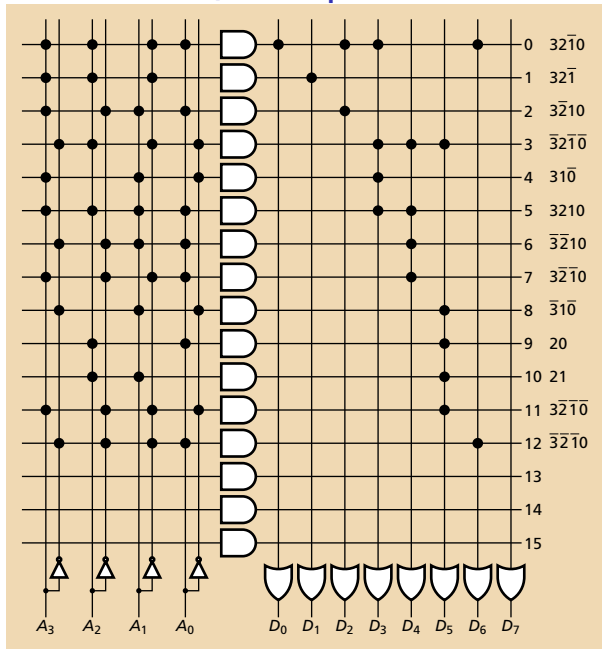

$$D_0 = \bar{3}\bar{2}\bar{1}0$$

$$D_1 = 3\bar{2}\bar{1}$$

$$D_2 = \bar{3}\bar{2}10 + 3\bar{2}\bar{1}0$$

$$D_3 = \bar{3}\bar{2}\bar{1}\bar{0} + 3\bar{1}\bar{0} + \bar{3}\bar{2}10 + 3210$$

$$D_4 = \bar{3}\bar{2}10 + \bar{3}\bar{2}\bar{1}\bar{0} + \bar{3}\bar{2}\bar{1}0 + 3210$$

$$D_5 = \bar{3}\bar{1}\bar{0} + 20 + 21 + \bar{3}\bar{2}\bar{1}\bar{0} + \bar{3}\bar{2}\bar{1}0$$

$$D_6 = \bar{3}\bar{2}\bar{1}0 + 3\bar{2}\bar{1}0$$

Our New PAL, the Space Race ROM

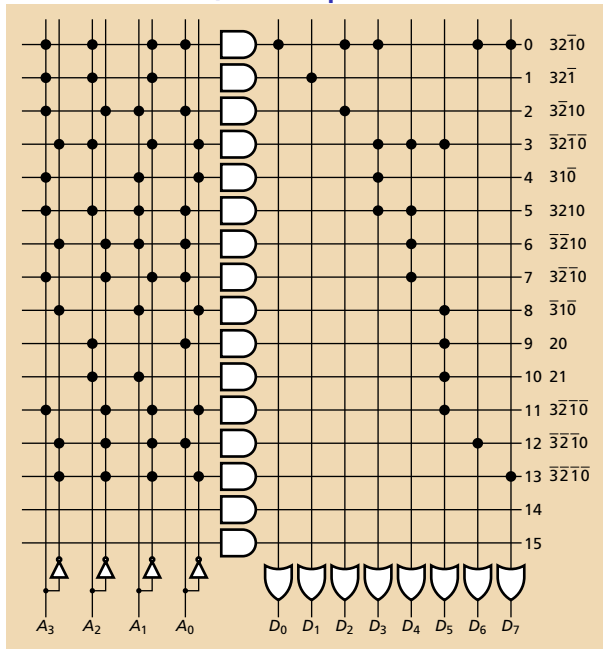

$$D_0 = 3\bar{2}\bar{1}0$$

$$D_1 = 3\bar{2}1$$

$$D_2 = 3\bar{2}\bar{1}0 + 3\bar{2}10$$

$$D_3 = \bar{3}\bar{2}\bar{1}0 + 310 + 3\bar{2}\bar{1}0 + 3210$$

$$D_4 = \bar{3}\bar{2}10 + \bar{3}\bar{2}\bar{1}0 + \bar{3}10 + 3\bar{2}\bar{1}0 + 3210$$

$$D_5 = \bar{3}10 + 20 + 21 + \bar{3}\bar{2}\bar{1}0 + \bar{3}\bar{2}10$$

$$D_6 = \bar{3}\bar{2}\bar{1}0 + 3\bar{2}\bar{1}0$$

$$D_7 = \bar{3}\bar{2}\bar{1}0 + 3\bar{2}\bar{1}0$$

Saved two ANDs

A 22V10 PAL: Programmable AND/Fixed OR

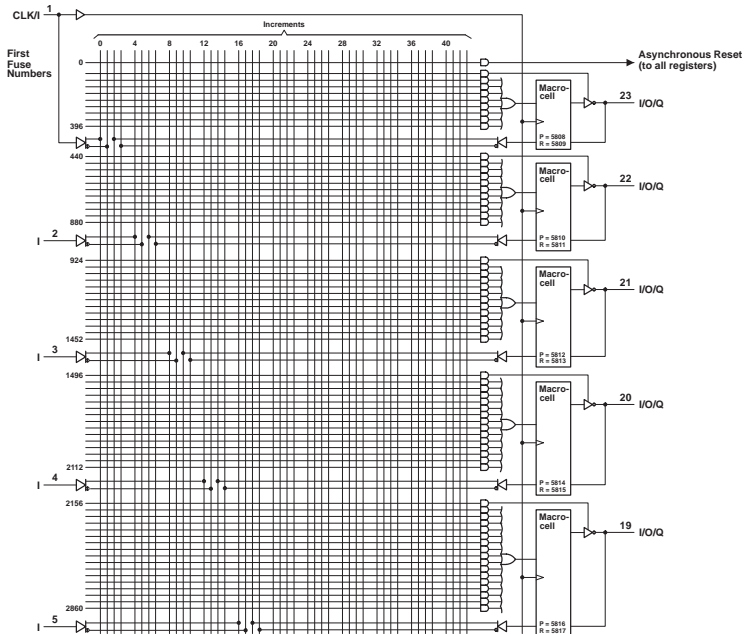

Field-Programmable Gate Arrays (FPGAs)

