



Serial Communications

Prof. Stephen A. Edwards
sedwards@cs.columbia.edu

Columbia University

Spring 2007

Early Serial Communication

Morse code key

Letters

A	•—
B	—•••
C	—•—•
D	—••
E	•
F	••—•
G	——•
H	••••
I	••
J	•— — —
K	—•—
L	•—••
M	— —
N	—•
O	— — —
P	•— —•
Q	— —•—
R	•—•
S	•••
T	—
U	••—
V	•••—
W	•— —
X	—••—
Y	—•— —
Z	— —••

Numbers

1	• — — — —
2	•• — — —
3	••• — —
4	•••• —
5	•••••
6	—••••
7	— —•••
8	— — —••
9	— — — —•
0	— — — — —

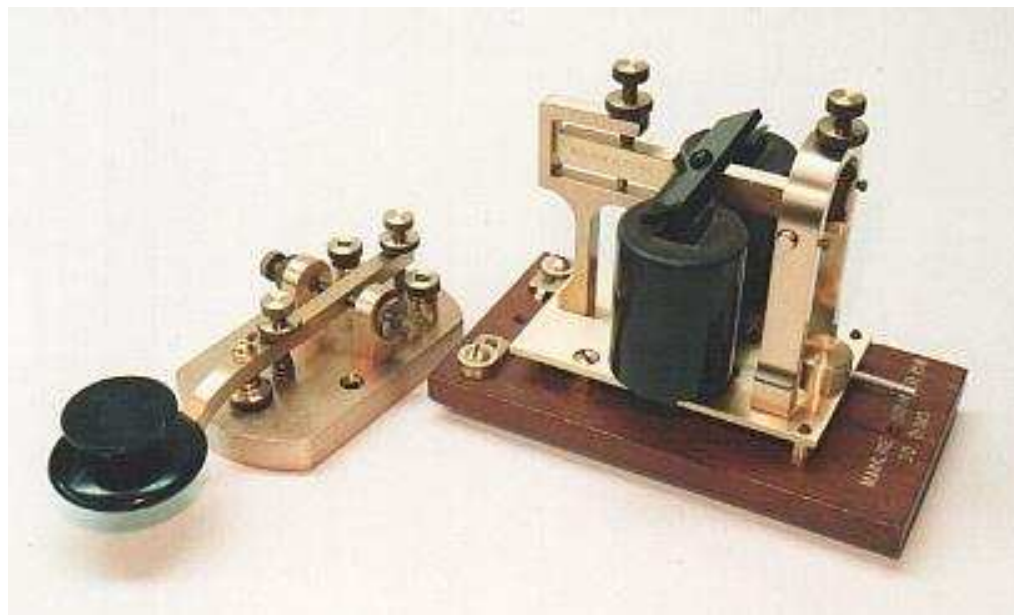

Later Serial Communication



Data Terminal Equipment



Data
Communications
Equipment

RS-232

Defined in early 1960s
Serial, Asynchronous, Full-duplex,
Voltage-based, point-to-point, 100 ft+ cables

+12V)
) SPACE = 0
+3V)

-3V)
) MARK = 1
-12V)

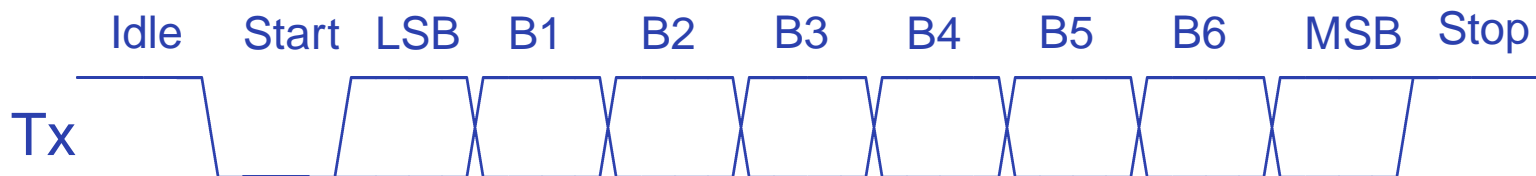

RS-232 Signals



Signal DB-9 DTE ... Meaning

	pin	DCE	
RxD	2	←	Data received by DTE
TxD	3	→	Data sent by DTE
SG	5	—	Ground
DSR	6	←	Data Set Ready (I'm alive)
DTR	4	→	Data Terminal Ready (me, too)
DCD	1	←	Carrier Detect (hear a carrier)
RTS	7	→	Request To Send (Yo?)
CTS	8	←	Clear To Send (Yo!)
RI	9	←	Ring Indicator

Receiving RS-232

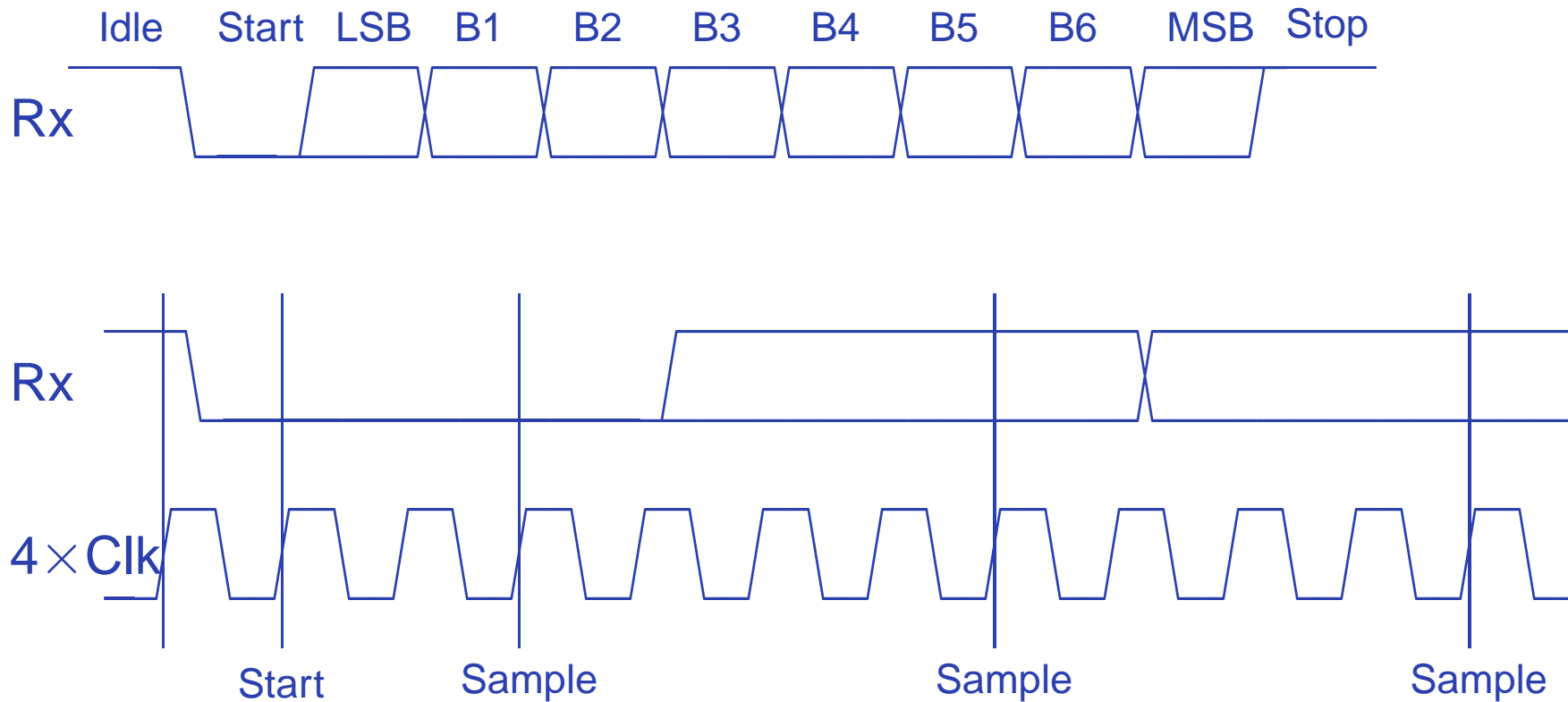

Most UARTs actually use $16\times$ clocks

Variants

Parity bit: (Even = true when even number of 1s)

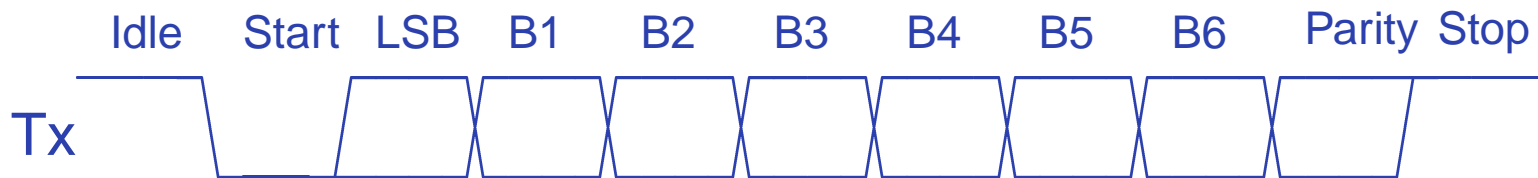

Two stop bits:

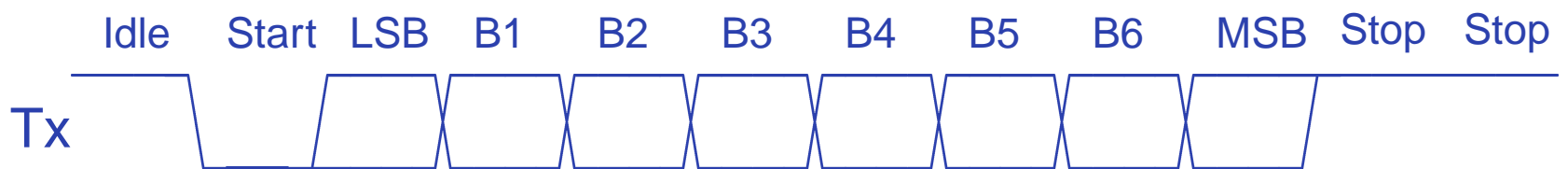

Baud Rate

Baud: bits per second

Baud	Application
-------------	--------------------

110	ASR-33 Teletype
-----	-----------------

300	Early acoustic modems
-----	-----------------------

1200	Direct-coupled modems c. 1980
------	-------------------------------

2400	Modems c. 1990
------	----------------

9600	Serial terminals
------	------------------

19200	
-------	--

38400	Typical maximum
-------	-----------------

Physical Variants

Connectors: DB-25, DB-9, Mini DIN-8

RS-422: Differential signaling

RS-485: Bus-like

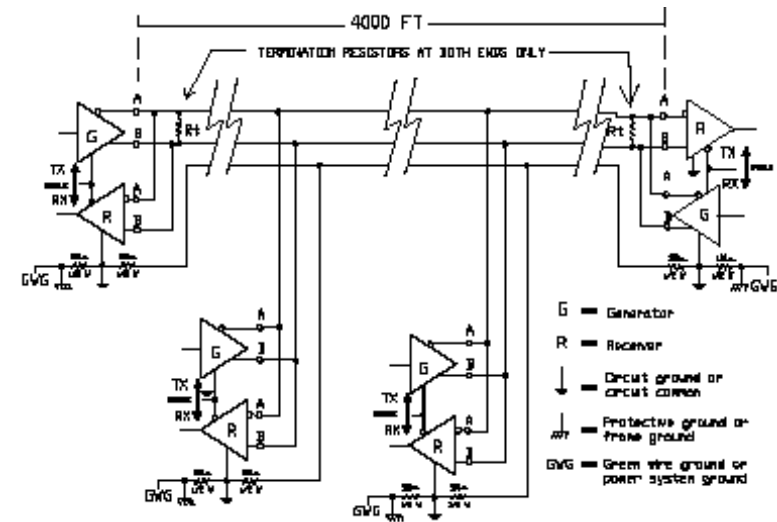
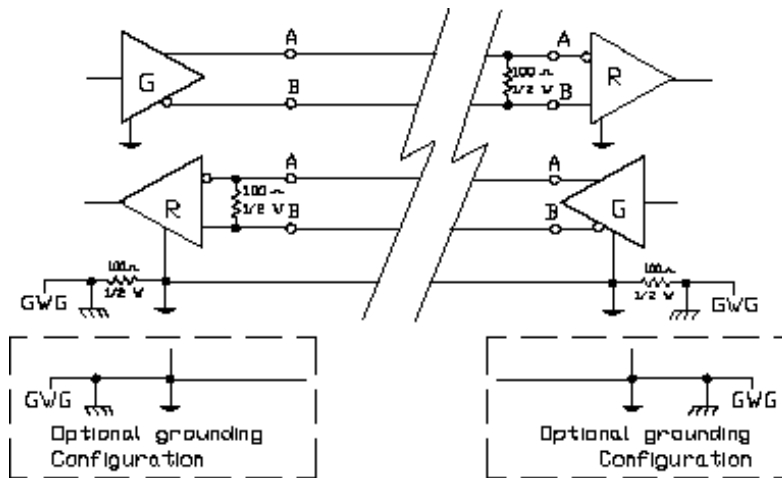

The I²C Bus

Philips invented the Inter-IC bus c. 1980 as a very cheap way to communicate slowly among chips

E.g., good for setting control registers

100, 400, and 3400 kHz bitrates

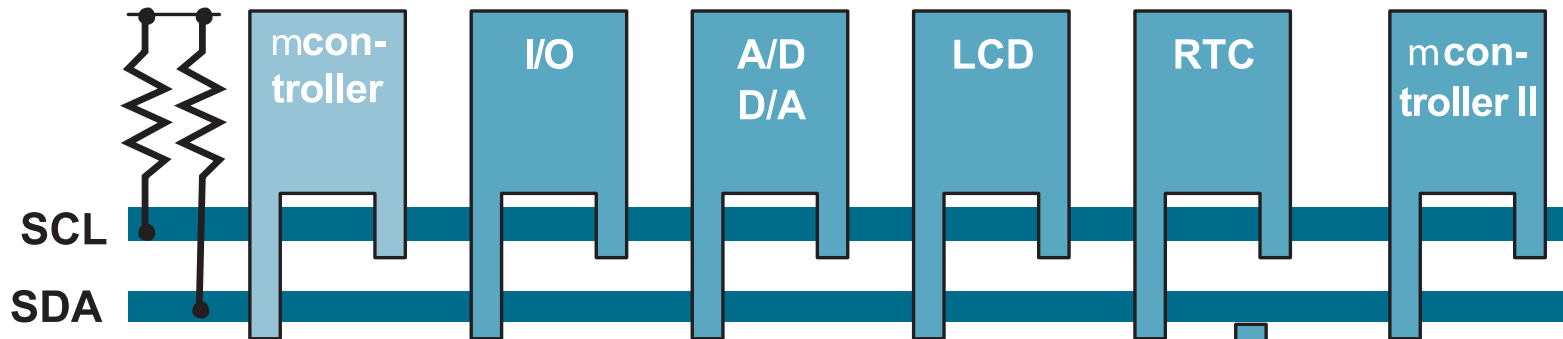

SCL: Clock, generated by a single master

SDA: Data, controlled by either master or slaves

I²C Bus Transaction

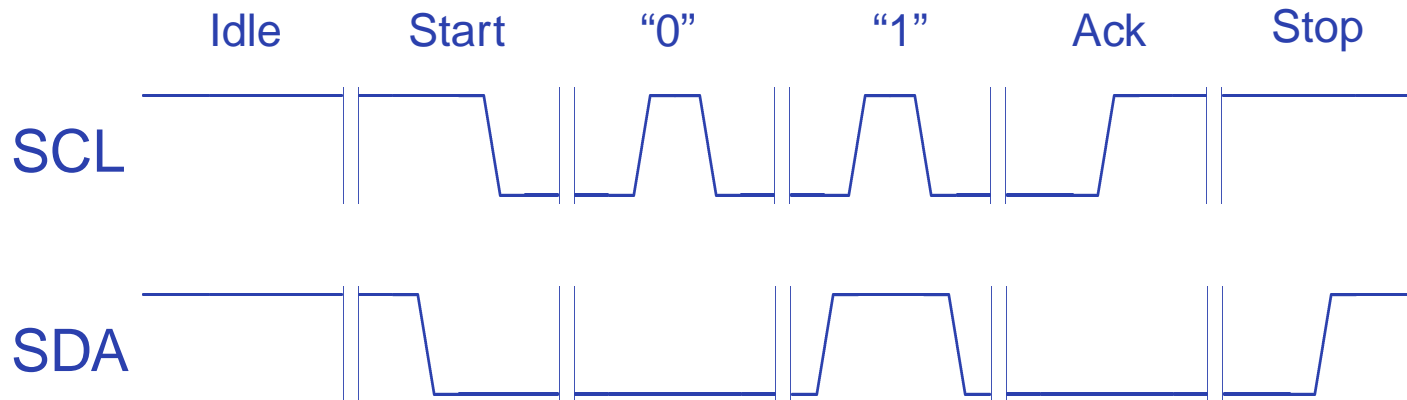

Write data

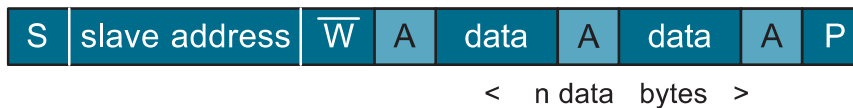

Read data

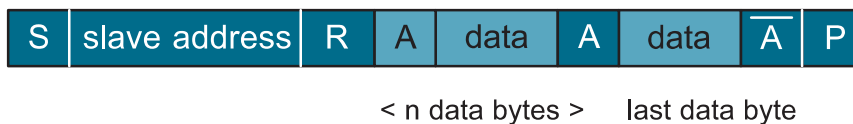

S = Start condition
 \overline{W} = read / write not
 A = Acknowledge
 \overline{A} = Not Acknowledge
 P = Stop condition

USB: Universal Serial Bus

1.5 Mbps, 12 Mbps, and 480 Mbps (USB 2.0)
Point-to-point, differential, twisted pair
3–5m maximum cable length

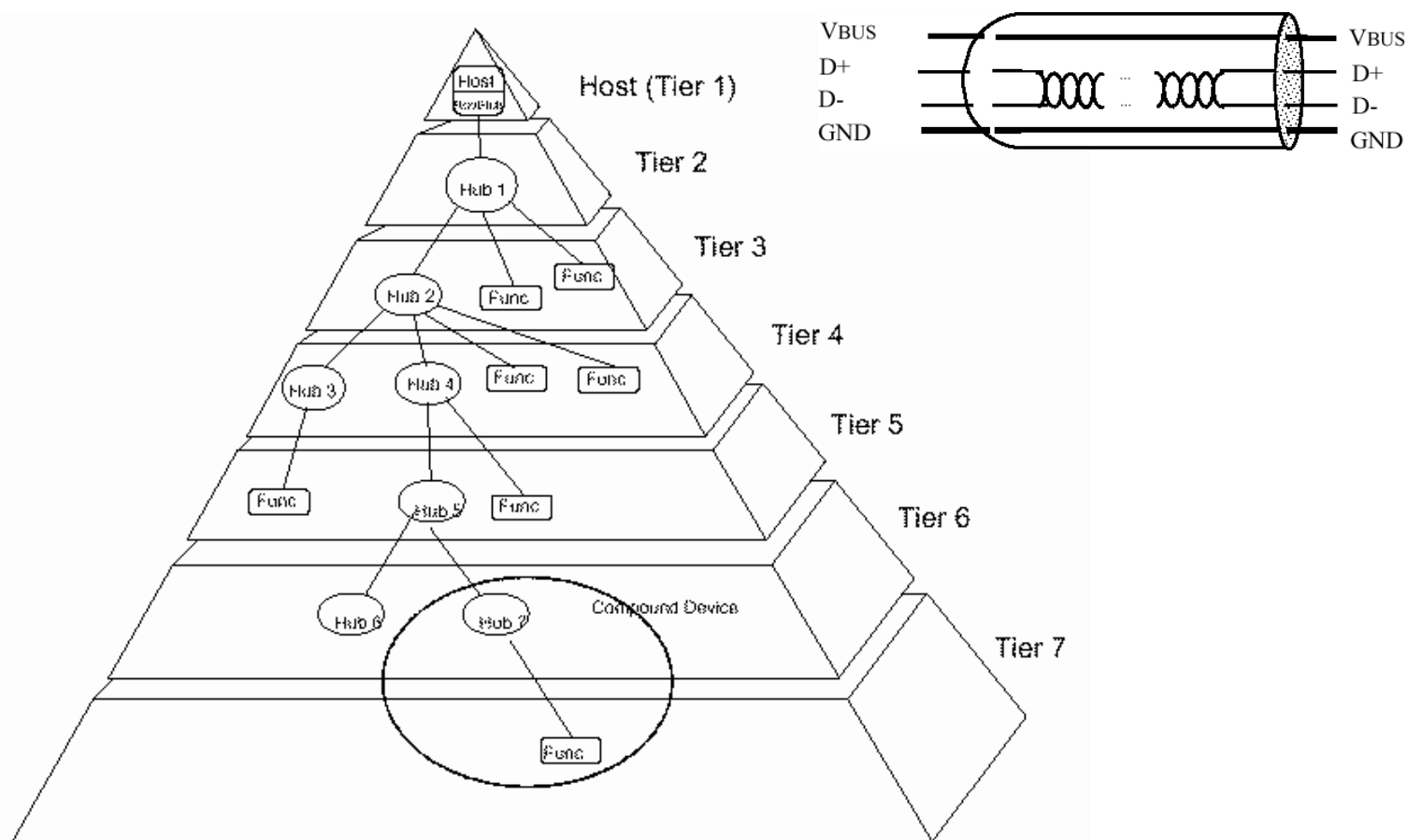

USB Connectors

Series "A" Connectors

- ◆ Series "A" plugs are always oriented **upstream** towards the *Host System*

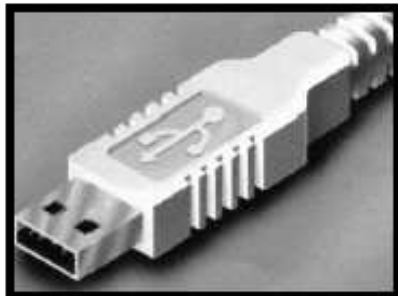

"A" Plugs
(From the
USB Device)

"A" Receptacles
(Downstream Output
from the USB Host or
Hub)



Series "B" Connectors

- ◆ Series "B" plugs are always oriented **downstream** towards the *USB Device*

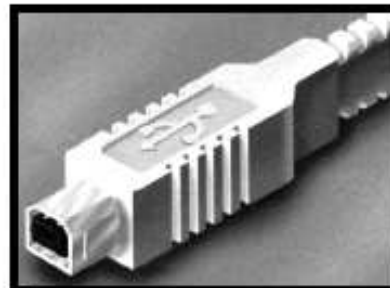

"B" Plugs
(From the
Host System)

"B" Receptacles
(Upstream Input to the
USB Device or Hub)

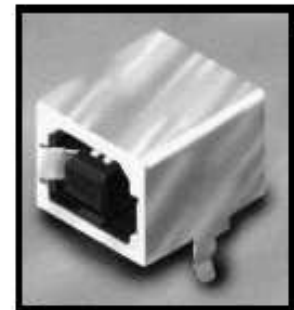

USB signaling

NRZI: 0 = toggle, 1 = no change

Bit stuffing: 0 automatically inserted after six consecutive 1s

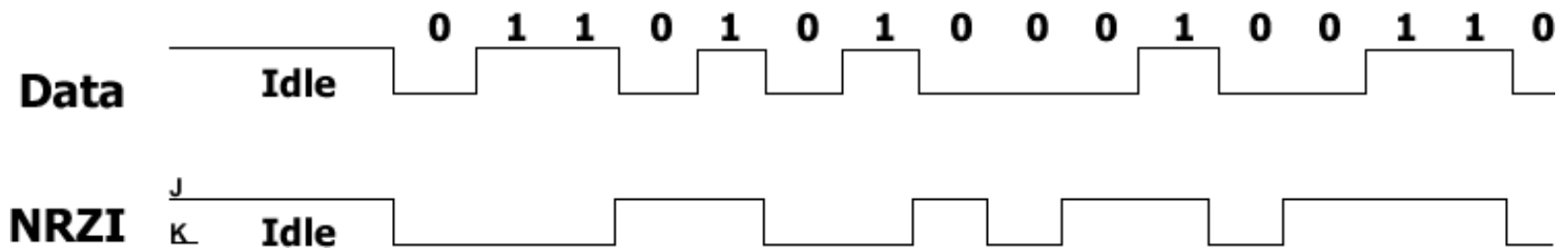

Each packet prefixed by a SYNC field: 3 0s followed by two 1s

Low- vs. full-speed devices identified by different pull-ups on D+/D- lines

USB Packets

Always start with SYNC

Then 4-bit type, 4-bit type complemented

2 bits distinguish Token, Data, Handshake, and Special, other two bits select sub-types

Then data, depending on packet type

Data checked using a CRC

Addresses (1-128) assigned by bus master, each with 16 possible endpoints

USB Bus Protocol

Polled bus: host initiates all transfers.

Most transactions involve three packets:

- “Token” packet from host requesting data
- Data packet from target
- Acknowledge from host

Supports both streams of bytes and structured messages (e.g., control changes).

USB Data Flow Types

- Control
For configuration, etc.
- Bulk Data
Arbitrary data stream: bursty
- Interrupt Data
Timely, reliable delivery of data. Usually events.
- Isochronous Data
For streaming real-time transfer:
prenegotiated bandwidth and latency

Layered Architecture

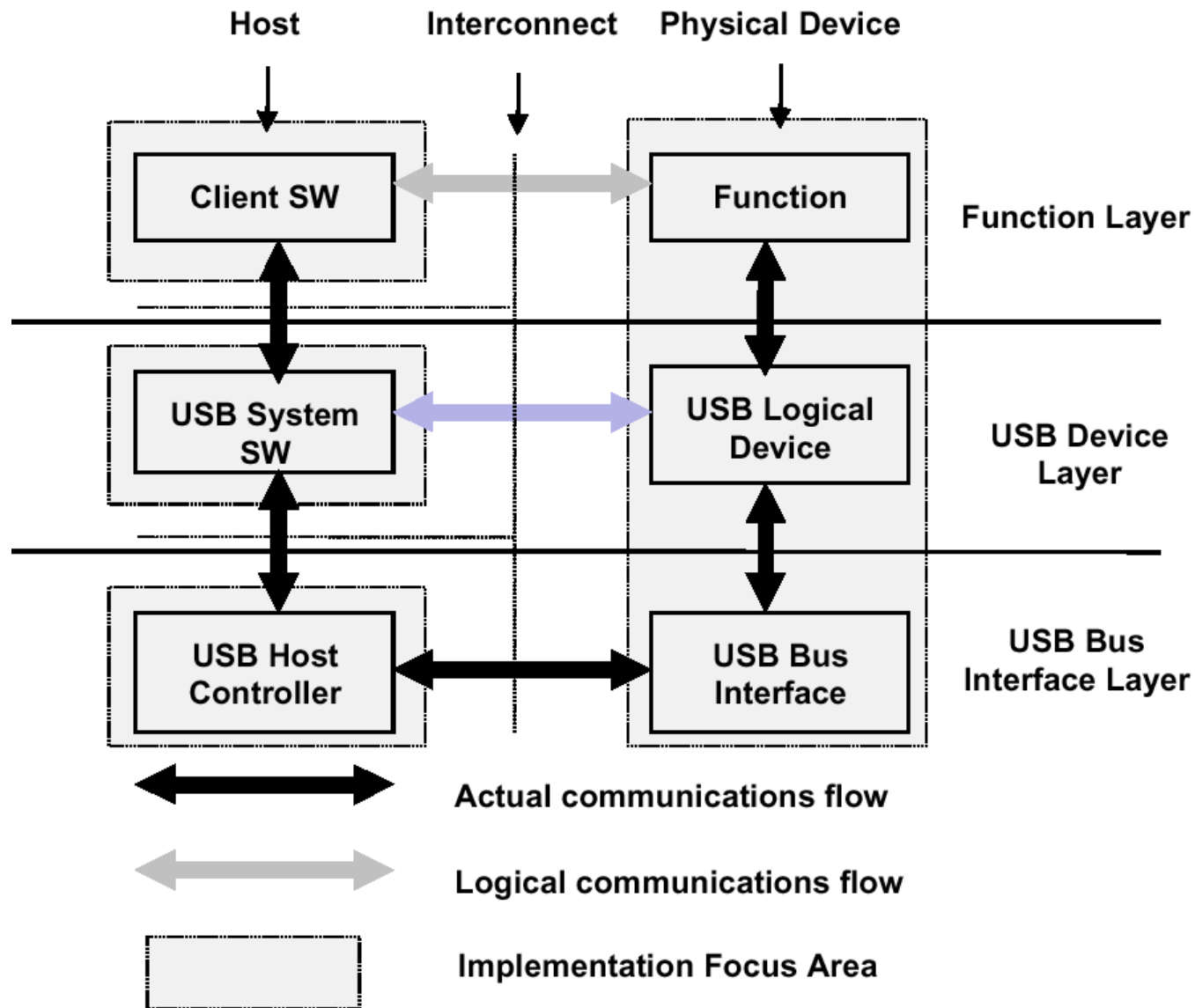

USB: Flash Card Device

```
Bus 001 Device 002: ID 05e3:0760 Genesys Logic, Inc.
bcdUSB                2.00
bMaxPacketSize0      64
idVendor              0x05e3 Genesys Logic, Inc.
idProduct             0x0760
bcdDevice             1.14
iManufacturer         2 Genesys
iProduct              3 Flash Reader
iSerial               4 002364
Configuration Descriptor:
  bNumInterfaces      1
  MaxPower             300mA
  Interface Descriptor:
    bNumEndpoints     2
    bInterfaceClass    8 Mass Storage
    bInterfaceSubClass 6 SCSI
    bInterfaceProtocol 80 Bulk (Zip)
    Endpoint Descriptor:
      bEndpointAddress 0x81 EP 1 IN
      bmAttributes      2
        Transfer Type   Bulk
        Synch Type      none
      wMaxPacketSize    64
    Endpoint Descriptor:
      bLength           7
      bDescriptorType   5
      bEndpointAddress 0x02 EP 2 OUT
      bmAttributes      2
        Transfer Type   Bulk
        Synch Type      none
      wMaxPacketSize    64
  Language IDs: (length=4)
    0409 English(US)
```

USB: Mouse Device

Bus 002 Device 002: ID 04b4:0001 Cypress Semiconductor Mouse

Device Descriptor:

```
bcdUSB          1.00
idVendor        0x04b4 Cypress Semiconductor
idProduct       0x0001 Mouse
bcdDevice       4.90
iManufacturer   1 Adomax Sem.
iProduct        2 USB Mouse
iSerial         0
```

Configuration Descriptor:

```
bNumInterfaces  1
bmAttributes    0xa0
  Remote Wakeup
MaxPower        100mA
```

Interface Descriptor:

```
bNumEndpoints  1
bInterfaceClass 3 Human Interface Devices
bInterfaceSubClass 1 Boot Interface Subclass
bInterfaceProtocol 2 Mouse
iInterface      5 EndPoint1 Interrupt Pipe
```

HID Device Descriptor:

```
bDescriptorType 34 Report
wDescriptorLength 52
```

Endpoint Descriptor:

```
bEndpointAddress 0x81 EP 1 IN
bmAttributes      3
  Transfer Type   Interrupt
  Synch Type      none
wMaxPacketSize    4
bInterval         10
```

Language IDs: (length=4)

```
0409 English(US)
```

Philips ISP1362 USB 2.0 Controller

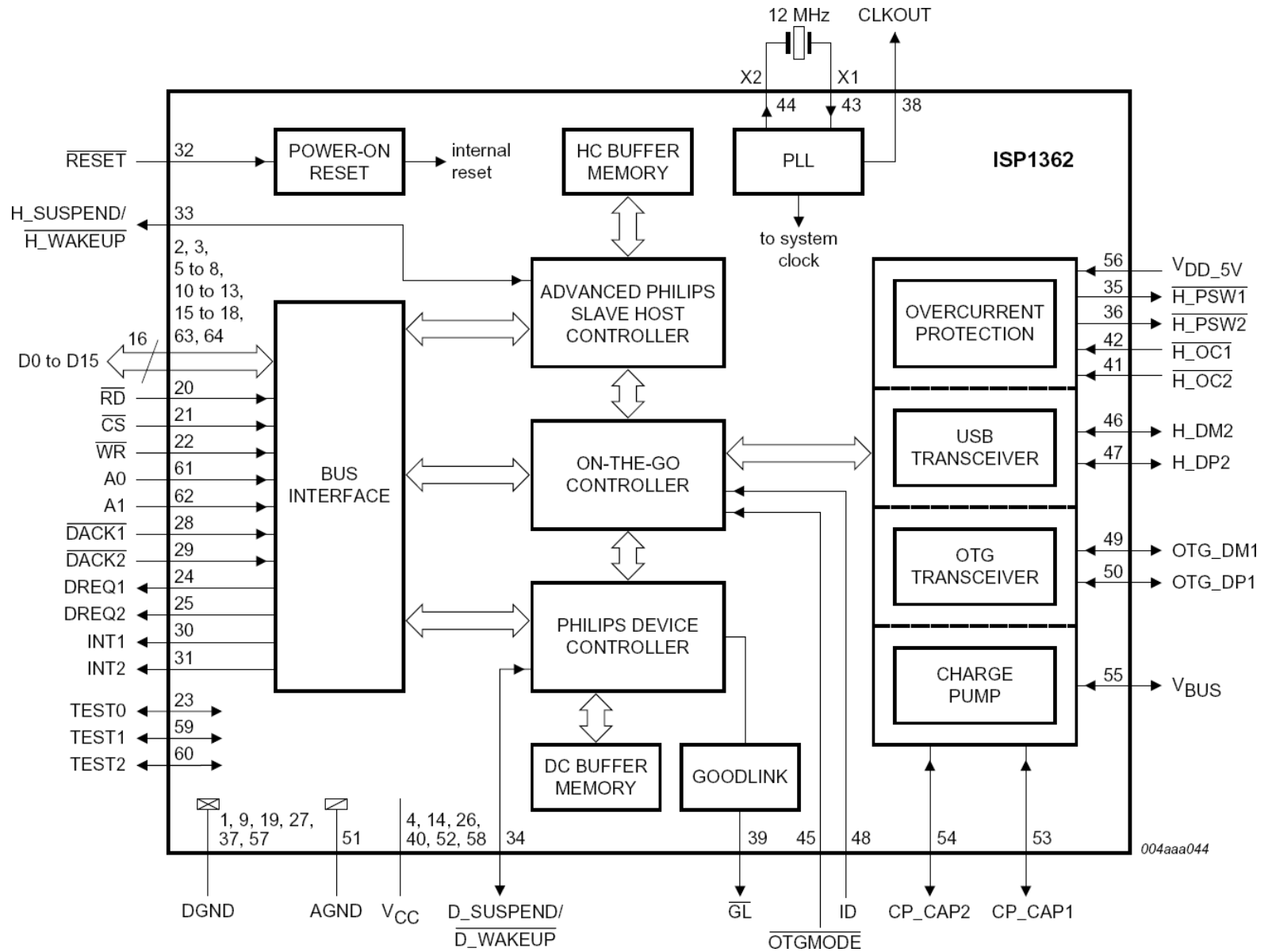

Philips ISP1362 USB 2.0 Controller

On the DE2, one downstream port, one host

Operates at 12 or 480 Mbps speeds

Two control endpoints + 14 user endpoints

4096 (host) + 2462 (device) bytes buffer memory

Supports DMA data transfers

Many configuration and status registers

150-page data “sheet” + 99-page embedded programming guide