



Embedded System Design

Prof. Stephen A. Edwards
sedwards@cs.columbia.edu

Spring 2007

Spot the Computer

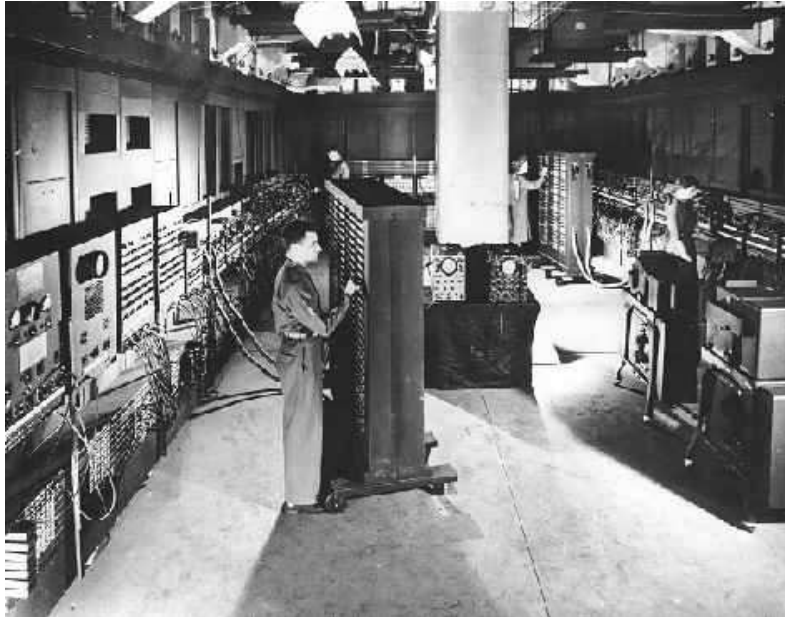

Hidden Computers



Casio
Camera
Watch



Nokia 7110
Browser
Phone



Sony
Playstation 2



Philips
DVD Player



Philips
TiVo Recorder

Technical Challenges



Real-time

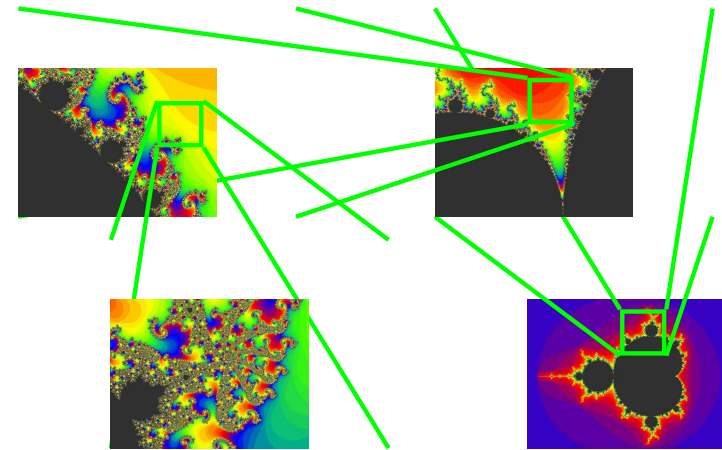

Complexity



Photo by Thomas Danoghue

Concurrency



Legacy Languages

Software complexity growing

Size of Typical Embedded System

1985 13 kLOC

1989 21 kLOC ↓ 44 % per year

1998 1 MLOC

2000 2 MLOC

2008 16 MLOC ≈ Windows NT 4.0

2010 32 MLOC ≈ Windows 2000

Source: "ESP: A 10-Year Retrospective," Embedded Systems Programming, November 1998

Digital Camera Block Diagram

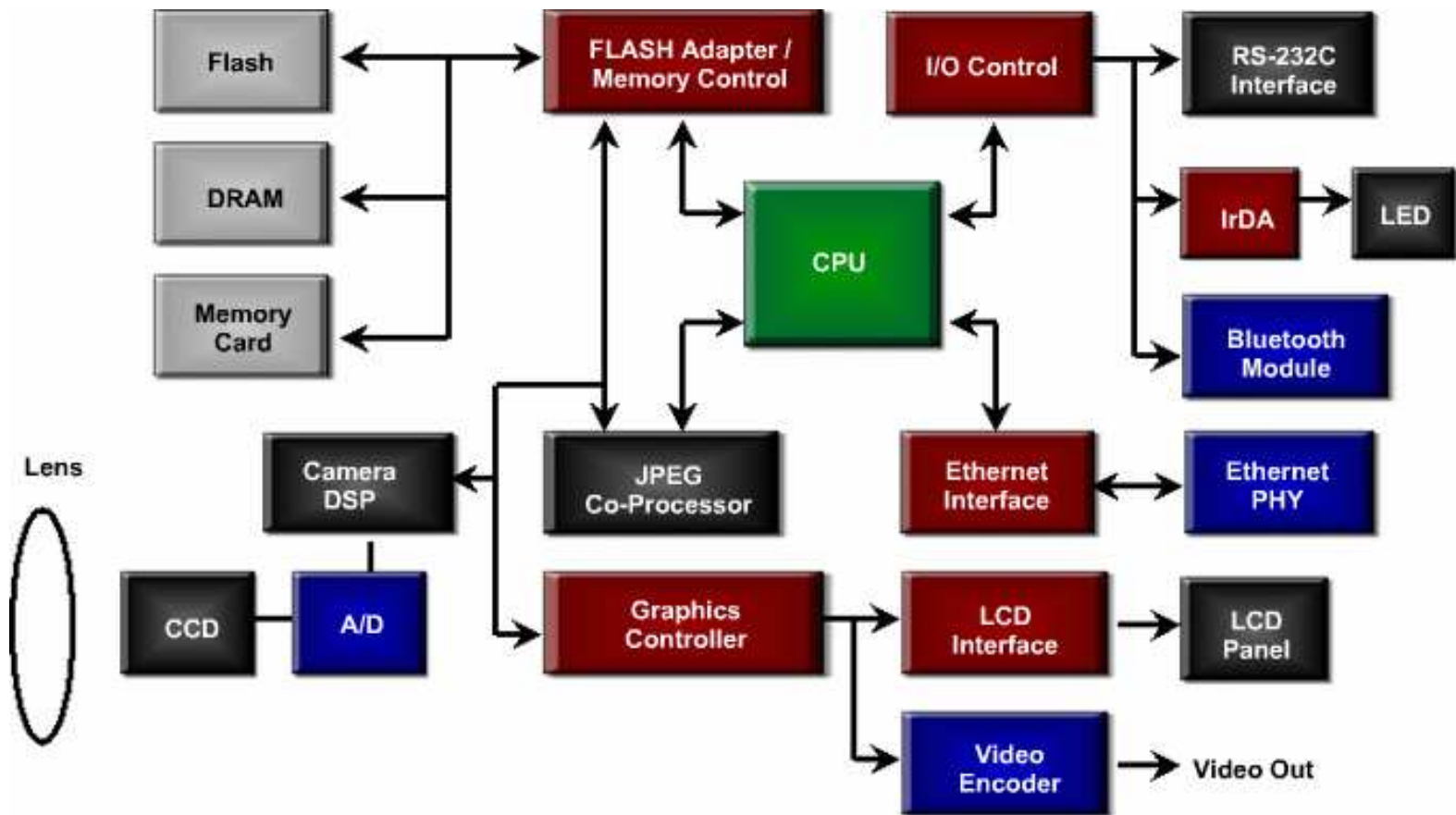

The Design Challenge

Design optimal device that meets constraints on



Price



Functionality



Performance



Size

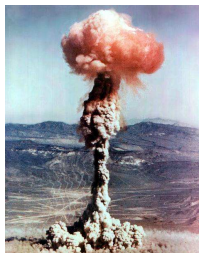

Power



Time-to-market



Maintainability

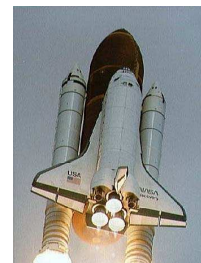

Safety

The Time-to-Market Challenge

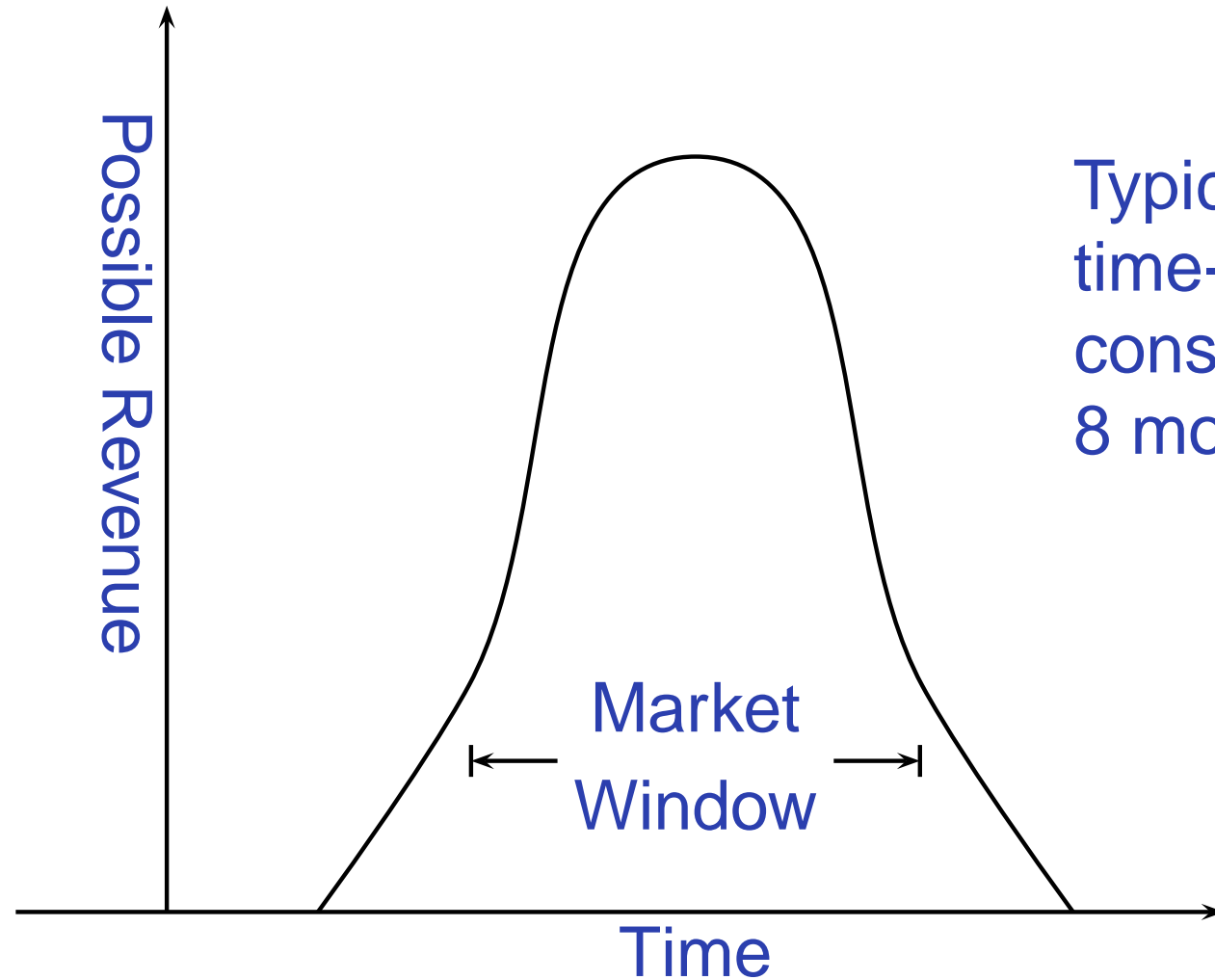

Typical
time-to-market
constraint:
8 months

Simplified Revenue Model

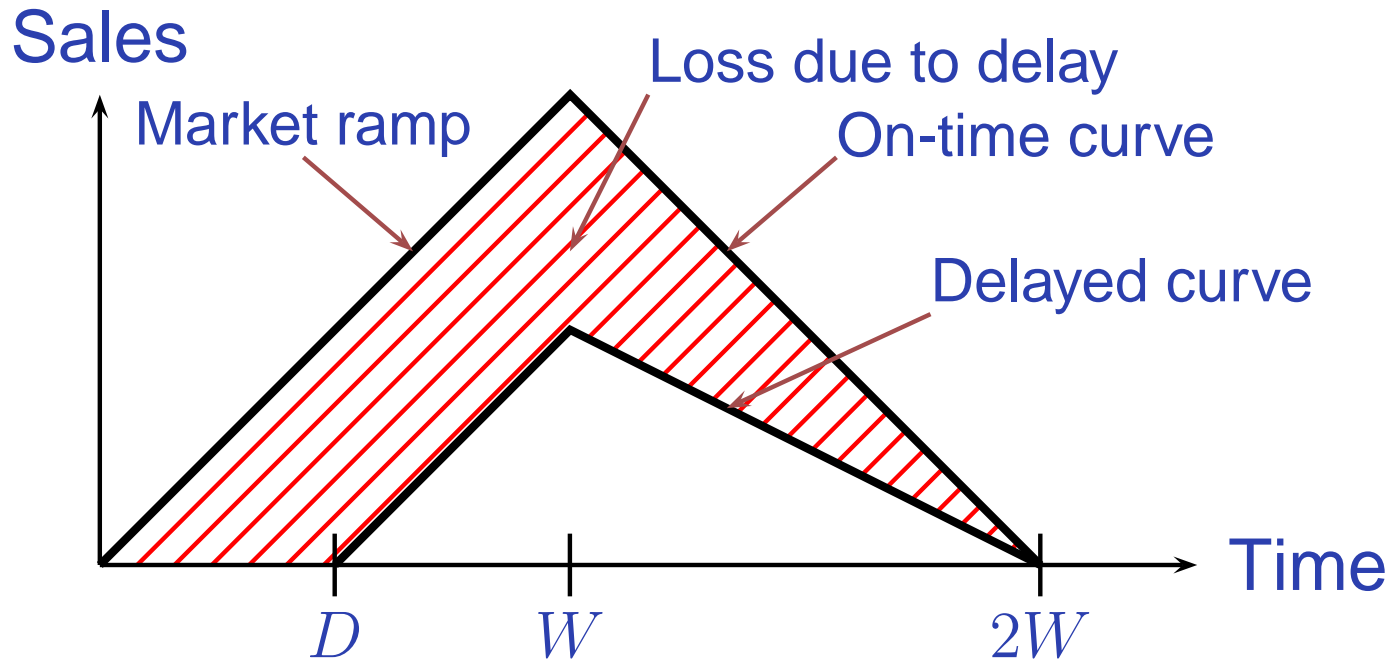

Assuming a constant market ramp, on-time revenue is $\frac{1}{2}bh = \frac{1}{2} \cdot 2W \cdot W = W^2$ and delayed revenue is $\frac{1}{2}(2W - D)(W - D)$ so fractional revenue loss is

$$\frac{D(3W - D)}{2W^2} = O(D^2)$$

Example: when $W = 26$ and $D = 10$, fraction lost is about 50%.

NRE

Nonrecurring engineering cost:
The cost of producing the first one.

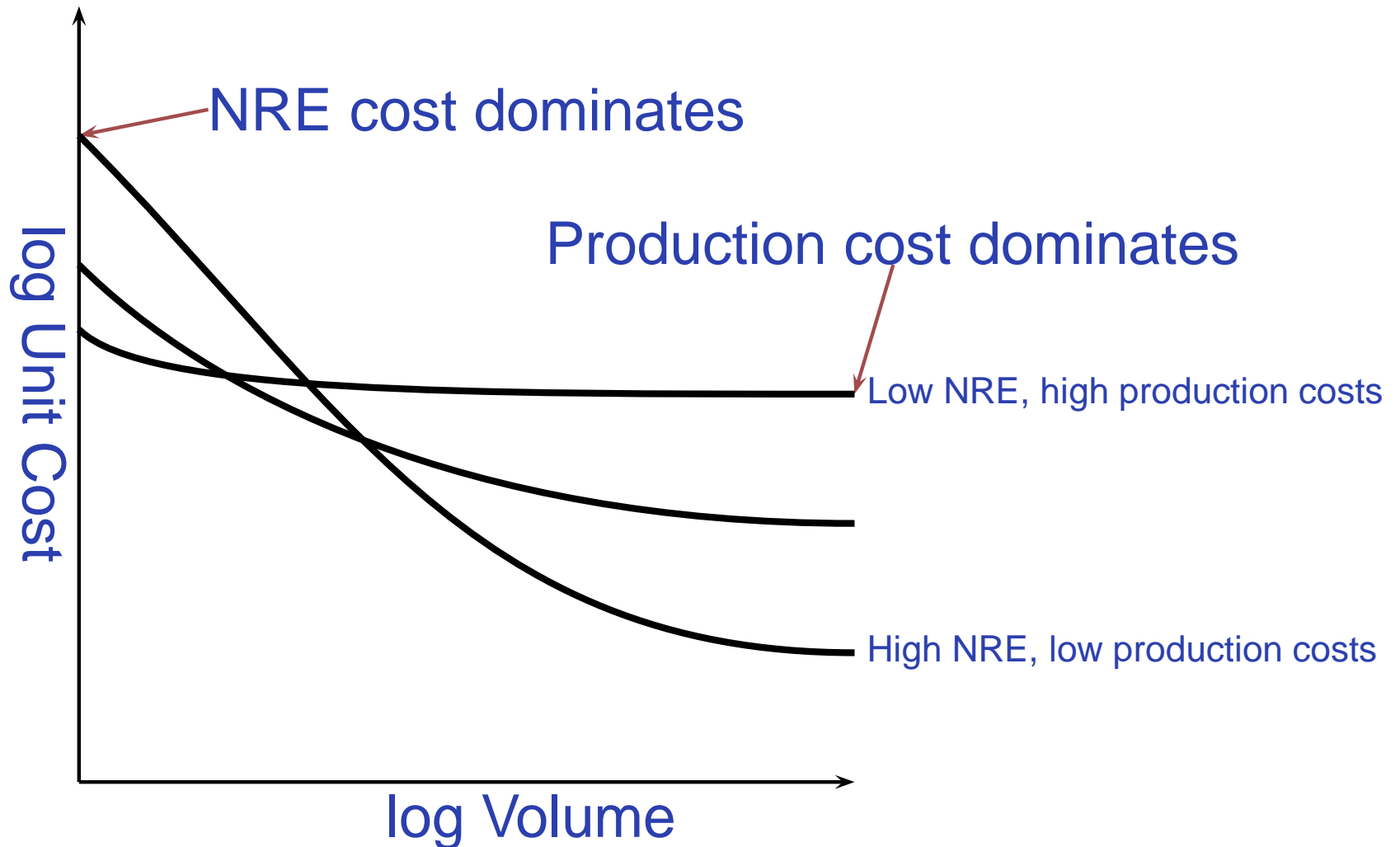

Embedded System Technologies

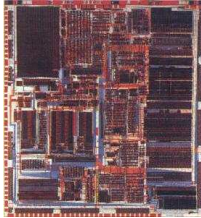

Integrated Circuits

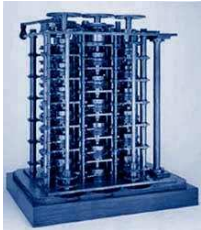

Processing elements



Design tools

IC Technology

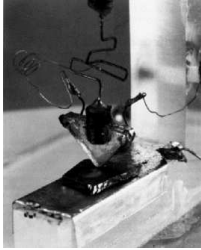

1947: First transistor (Shockley, Bell Labs)



1958: First integrated circuit (Kilby, TI)

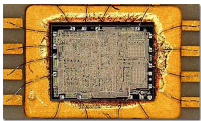

1971: First microprocessor (4004: Intel)

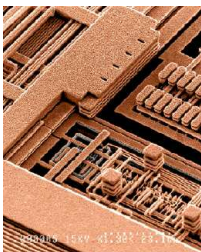

Today: six wire layers, 45 nm features

Moore's Law

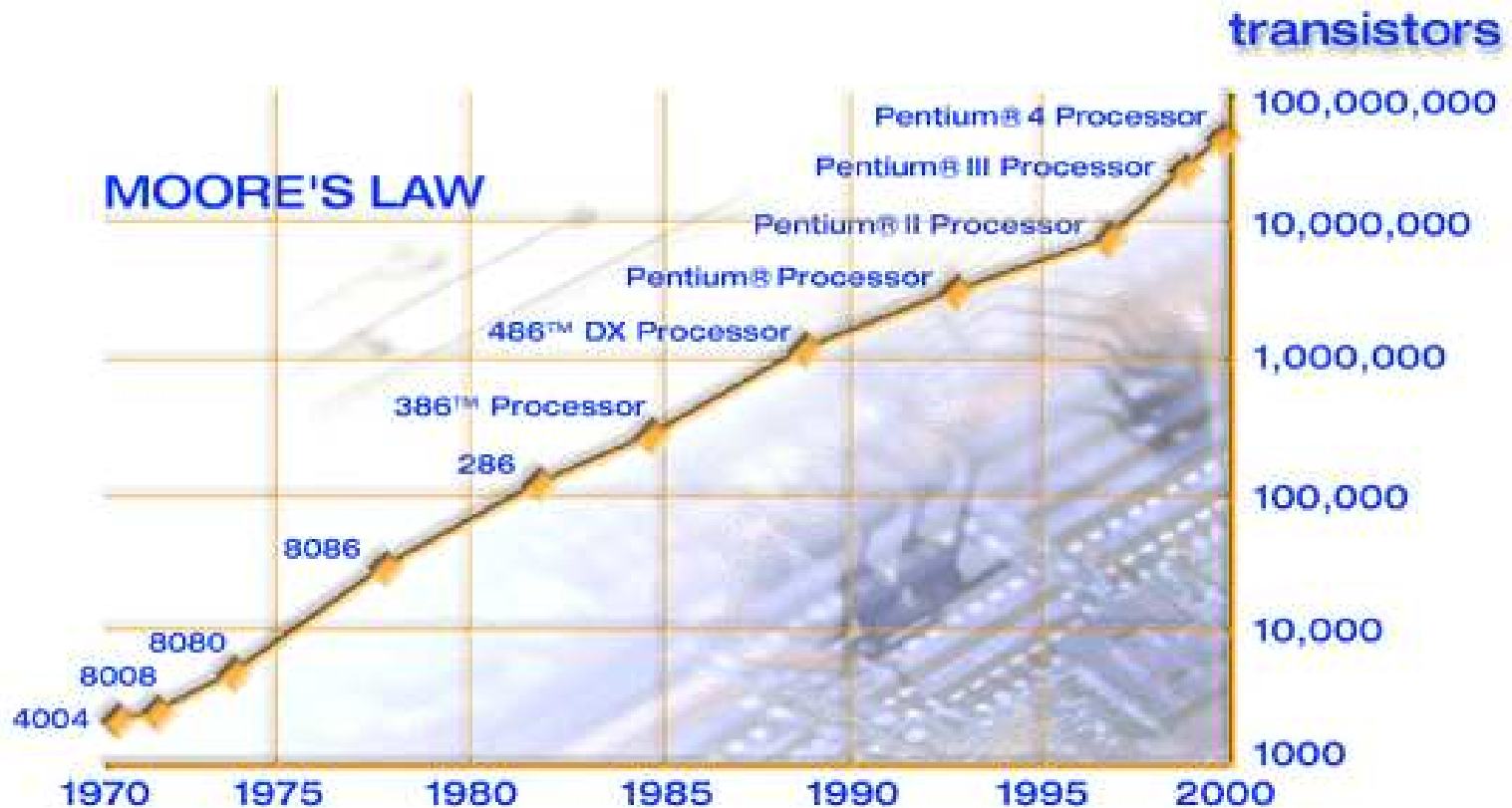

Gordon Moore, 1965: Exponential growth in the number of transistors per IC

Source: Intel

\$1000 buys you this many CPS

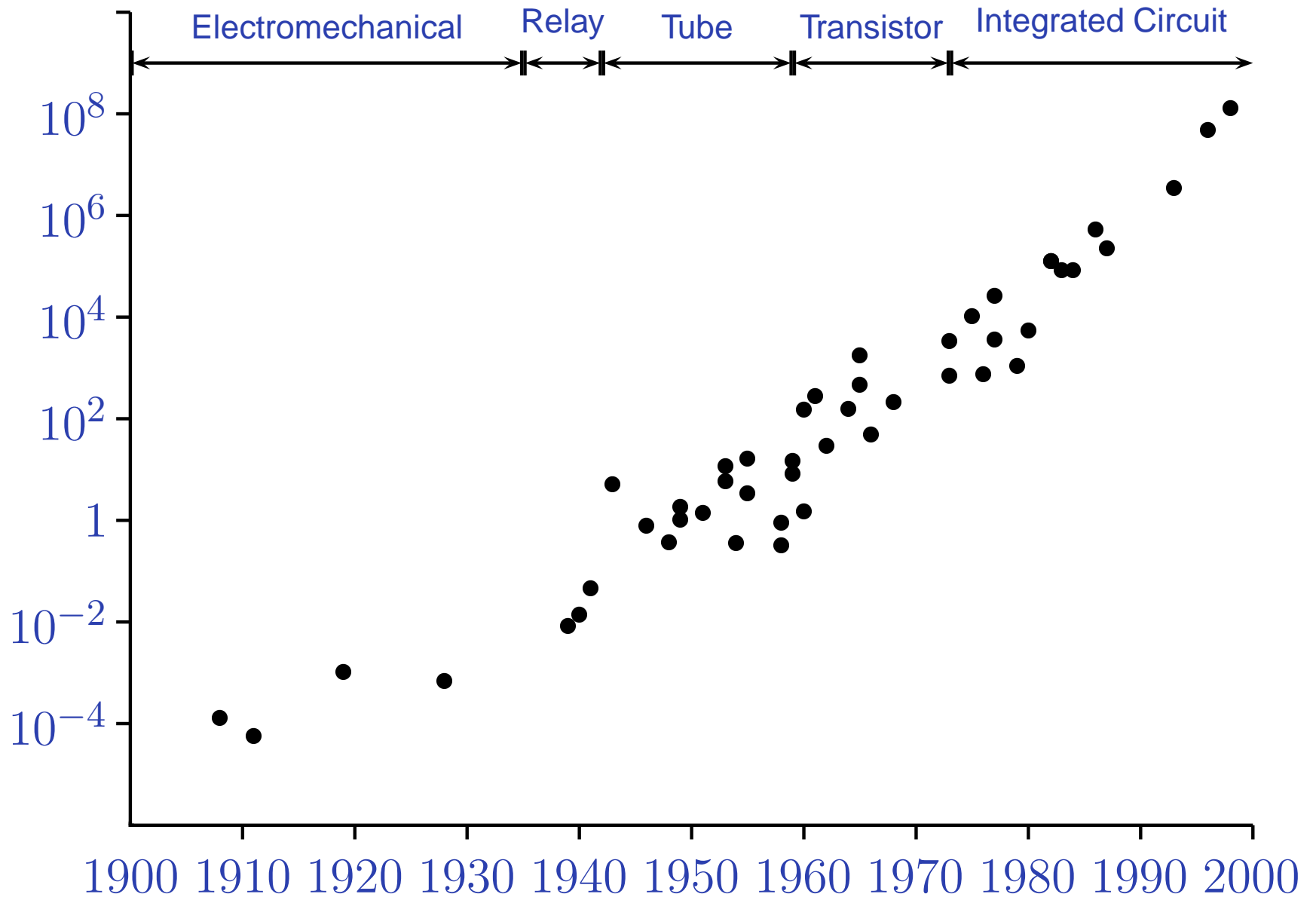

Source: Ray Kurzweil, *The Age of Spiritual Machines*

1918 Sears Roebuck Catalog

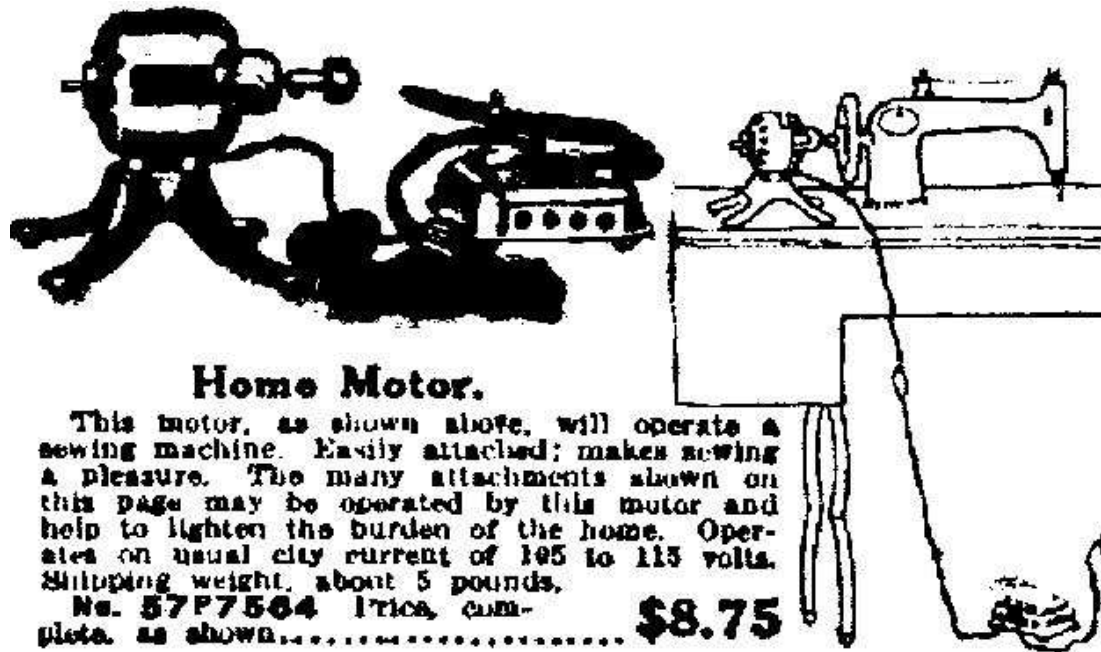

Home Motor.

This motor, as shown above, will operate a sewing machine. Easily attached; makes sewing a pleasure. The many attachments shown on this page may be operated by this motor and help to lighten the burden of the home. Operates on usual city current of 105 to 115 volts. Shipping weight, about 5 pounds.

No. 57F7564 Price, complete, as shown..... **\$8.75**



Beater Attachment.

Whips cream and beats eggs, and many other uses will be found for these attachments when used in connection with the Home Motor. Parts include the stand, handle and the beater. Shipping weight, about 14 ounces.

No. 57F7585 Price..... **\$1.30**



Churn and Mixer Attachment.

Used in connection with the Home Motor, makes a small churn and mixer for which you will find many uses. The attachments include the base, supports, mixer, handle and special cover for jar. Shipping weight, about 1 3/4 pounds.

No. 57F7582 Price..... **\$1.30**



Fan Attachment.

Includes fan and guard which can be quickly attached to Home Motor, and will be a great comfort in hot weather. Shipping weight, about 14 ounces.

No. 57F6215 Price..... **\$1.30**

About \$100 in today's dollars.

From Donald Norman, *The Invisible Computer*, 1998.

Spectrum of IC choices



Hardware and Software

Hardware

Parallel

Synchronous

Logic Gates

Wire-based

communication

Fixed topology

Low power

More detailed

High NRE

Faster

Software

Sequential

Asynchronous

Stored programs

Memory-based

communication

Highly programmable

High power

Less detailed

No NRE

Slower

Design Tools

Hardware

Logic Synthesis

Place-and-route

DRC/ERC/LVS

Simulators

Software

Compilers

Assemblers

Linkers

Debuggers

Cost of Designs is Rising

1981: 100 designer-months for leading-edge chip
10k transistors, 100 transistors/month

2002: 30 000 designer-months
150M transistors, 5000 transistors/month

Design cost increased from \$1M to \$300M

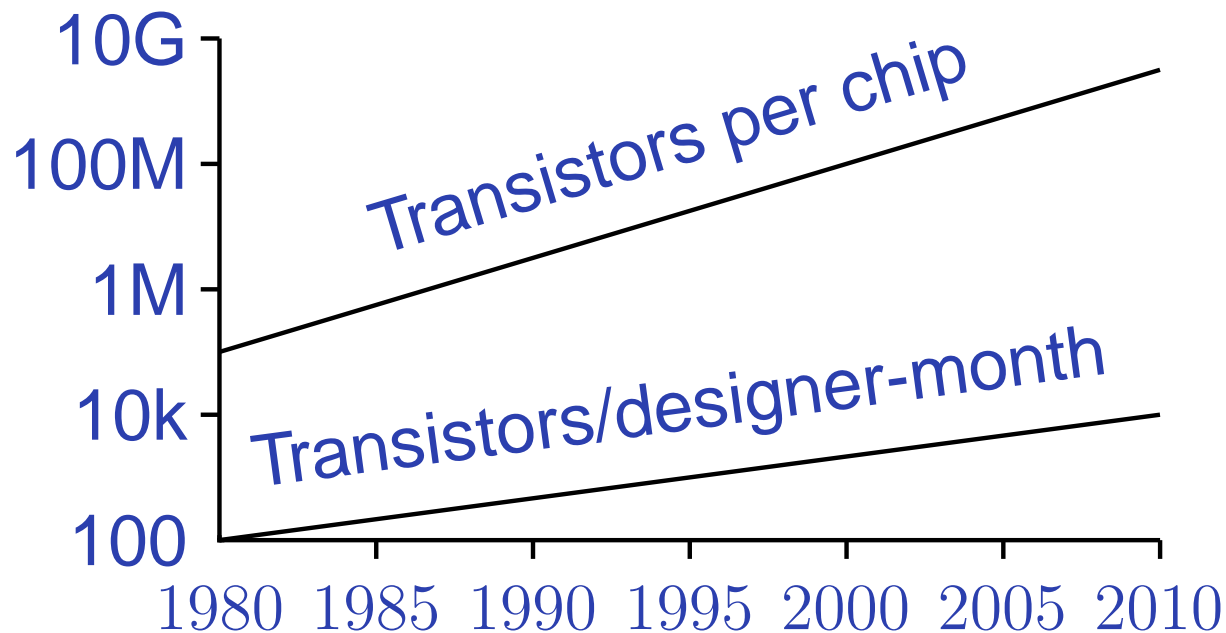

Your Nemesis: The Altera DE2

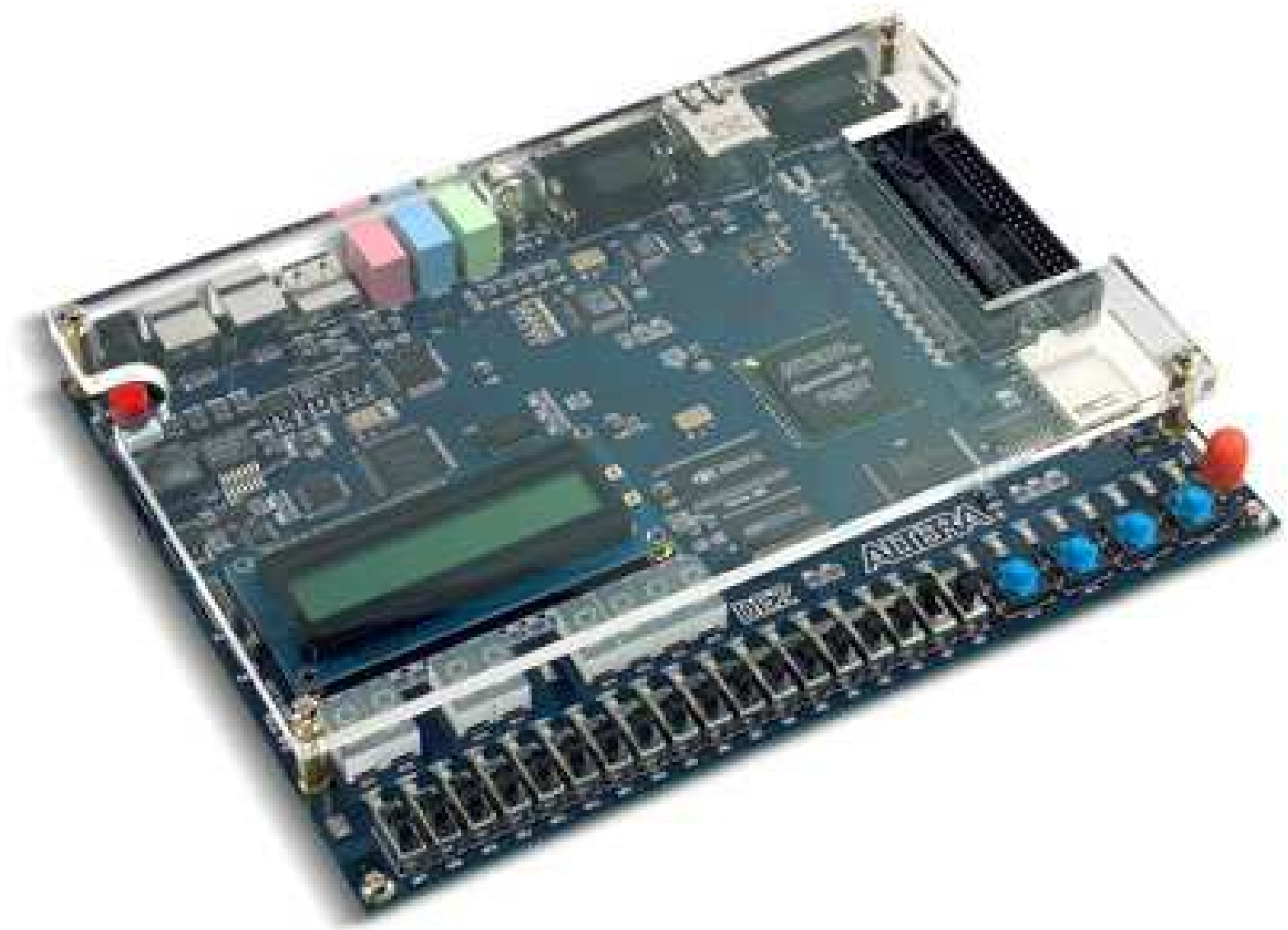

DE2 Peripherals

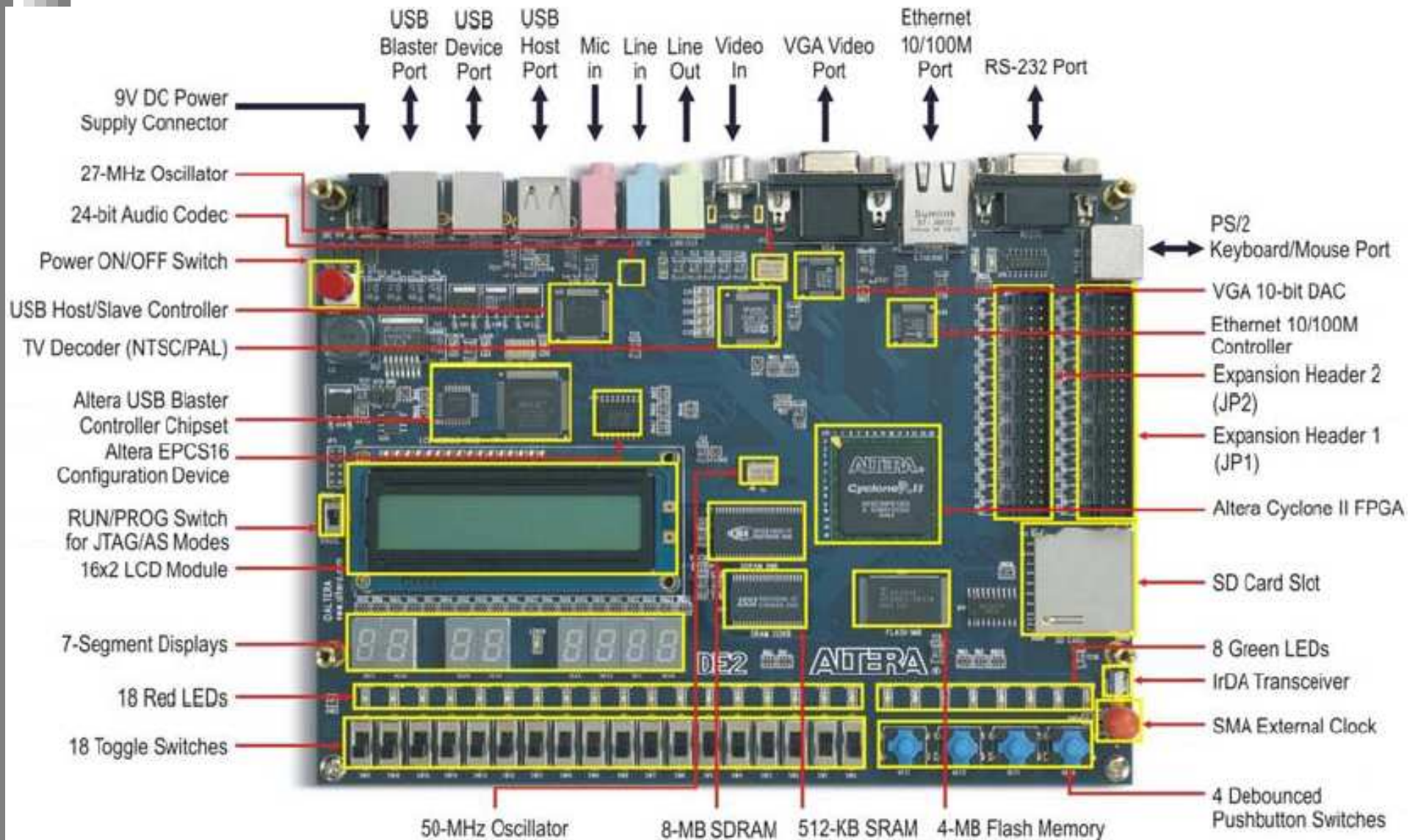

Class Structure

Three Introductory Labs: 1.5 weeks each

1. Access, modify, and display memory in VHDL
2. An Ethernet chat client (software only)
3. Either
 - (a) an FM audio synthesizer;
 - (b) a video bouncing ball; or
 - (c) image convolution with a 3×3 kernel

The project: **Design-your-own**

Custom Project Ideas

Broadly: C + VHDL + peripheral(s)

Video game (e.g., Pac-Man)

Video effects processor

Digital picture frame

Serial terminal

Serial port monitor

Very fancy digital clock (w/ video)

More Ideas

Digital tone control

Digital sound effects processor

Real-time audio spectrum analyzer

Speech synthesizer

Internet radio

Projects from 2004

MIDI synthesizer

Line-following robot with video vision

SAE student vehicle telemetry system

Stereo video vision system

Pac-man-like video game

Internet video camera

Projects from 2005

Scrabble Timer

Scorched Earth Video Game

SAE Auto Shifter

Internet Radio Broadcaster

3D Maze Game

Voice-over-IP Telephone

JPEG decoder

Sokoban video game

Rally-X video game

Projects from 2006

Video-guided Lego Robot

360° camera de-warper

Videogame with accelerated line-drawing

Voice recorder

Internet radio

JPEG decoder

Voice over IP tranceiver