

From
Recursive Functions to
Real FPGAs

Stephen A. Edwards

Columbia University

CCPC, 4 March 2012

$(\lambda x.?) f = \text{FPGA}$

Parallelism is the Big Question



Massive On-Chip Parallelism is Inevitable

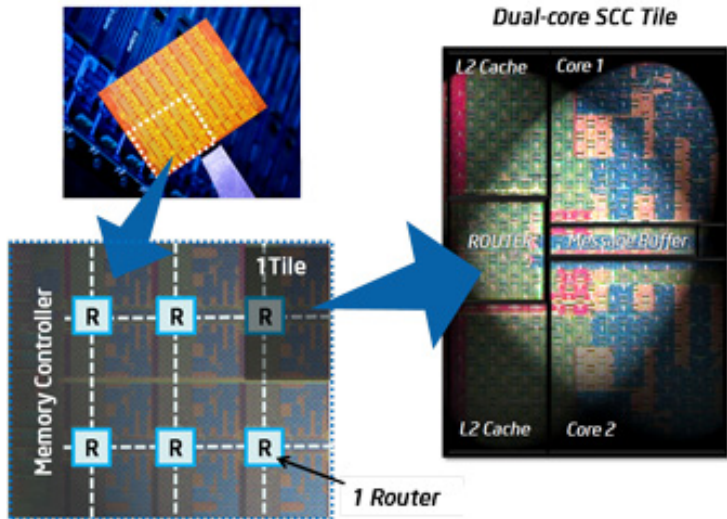

Intel's 48-core "Single Chip Cloud Computer"

The Future is Wires and Memory

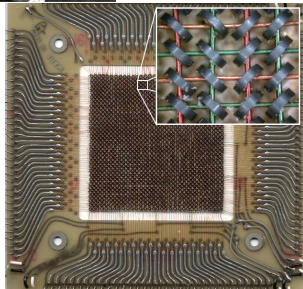
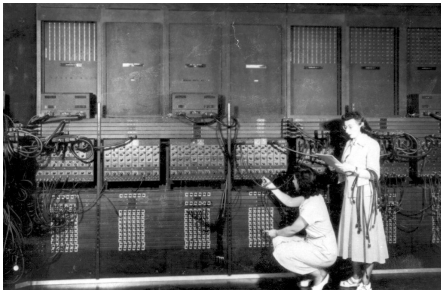

...and it's Already Here

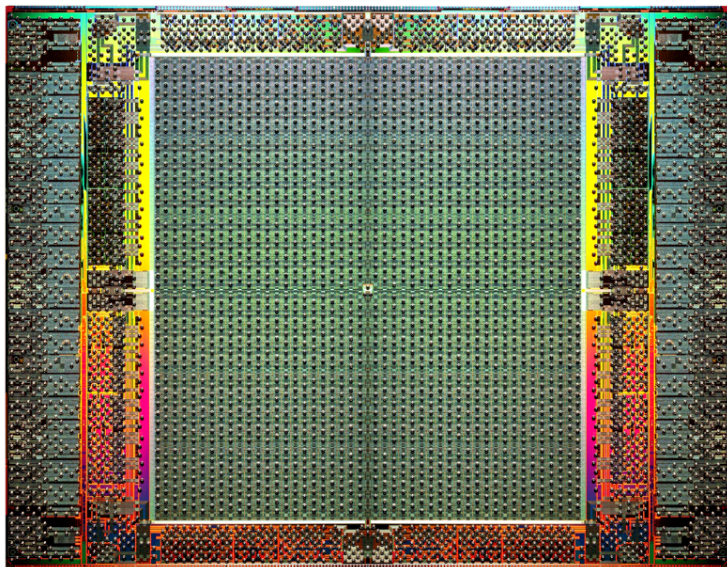

Altera Stratix IV FPGA

What We are Doing About It

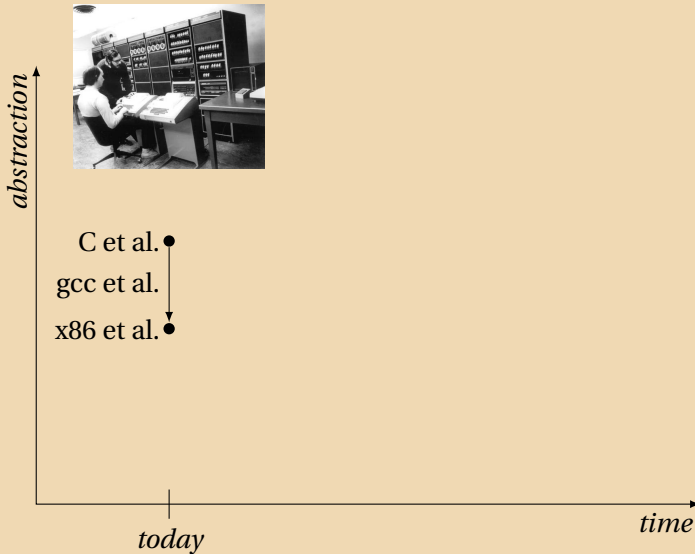

What We are Doing About It

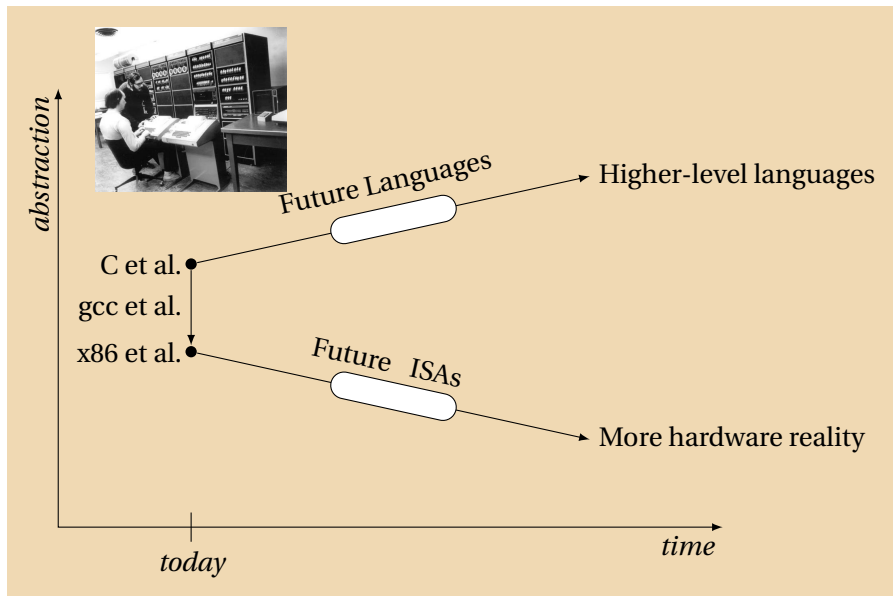

What We are Doing About It

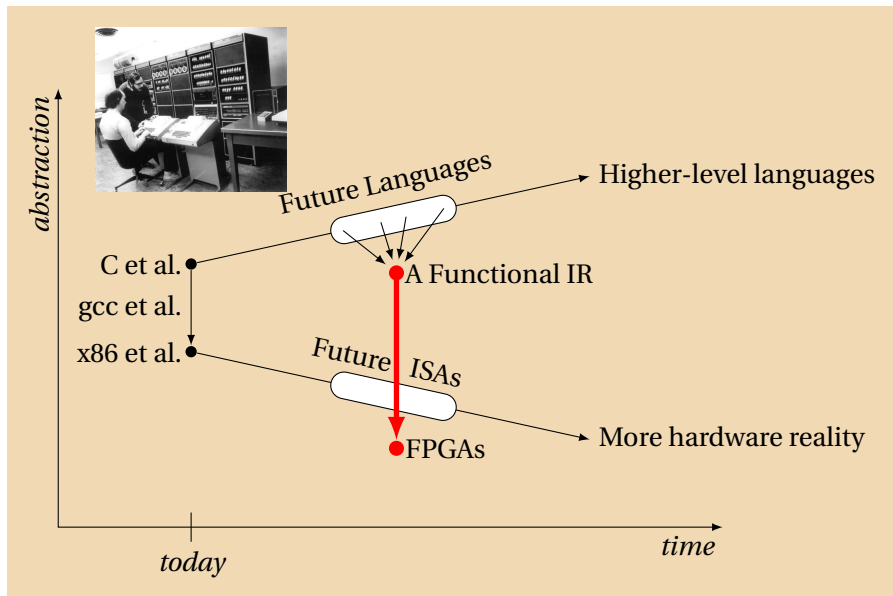

Why Functional Specifications?

- ▶ Referential transparency/side-effect freedom make formal reasoning about programs vastly easier
- ▶ Inherently concurrent and race-free (Thank Church and Rosser). If you want races and deadlocks, you need to add constructs.
- ▶ Immutable data structures makes it vastly easier to reason about memory in the presence of concurrency



Why FPGAs?

- ▶ We do not know the structure of future memory systems
Homogeneous/Heterogeneous?
Levels of Hierarchy?
Communication Mechanisms?
- ▶ We do not know the architecture of future multi-cores
Programmable in Assembly/C?
Single- or multi-threaded?



Use FPGAs as a surrogate. Ultimately too flexible, but representative of the long-term solution.

The Memory Hierarchy is the Interesting Part

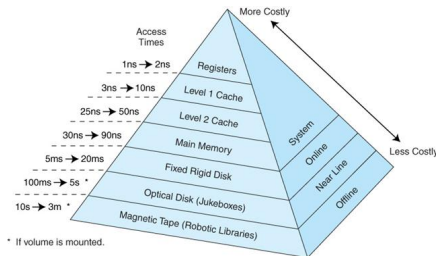

Multiprocessor Memory is a Headache

- ▶ Cache Coherency
- ▶ Write buffers
- ▶ Sequential Memory Consistency
- ▶ Memory barriers
- ▶ Data Races
- ▶ Atomic operations

Immutable data structures simplify these

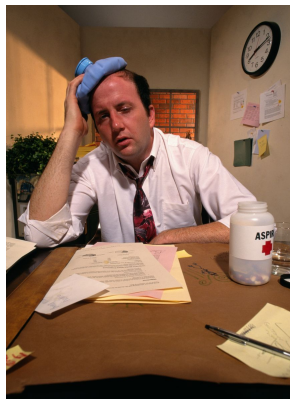

The Practical Question

*How do we synthesize hardware
from pure functional languages
for FPGAs?*

Control and datapath are easy; the memory system is interesting.

To Implement Real Algorithms in Hardware, We Need

Structured, recursive data types



Recursion to handle recursive data types



Memories

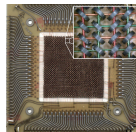

Memory Hierarchy



Example: Huffman Decoder in Haskell

```
data HTree = Branch HTree HTree  
          | Leaf Char
```

```
decode :: HTree -> [Bool] -> [Char] -- Huffman tree & bitstream to symbols
```

```
decode table str = decoder table str
```

where

```
decoder (Leaf s) i = s : (decoder table i) -- Identified symbol; start again
```

```
decoder _ [] = []
```

```
decoder (Branch f _) (False:xs) = decoder f xs -- 0: follow left branch
```

```
decoder (Branch _ t) (True:xs) = decoder t xs -- 1: follow right branch
```

Three data types: Input bitstream, output character stream, and Huffman tree

Planned Optimizations

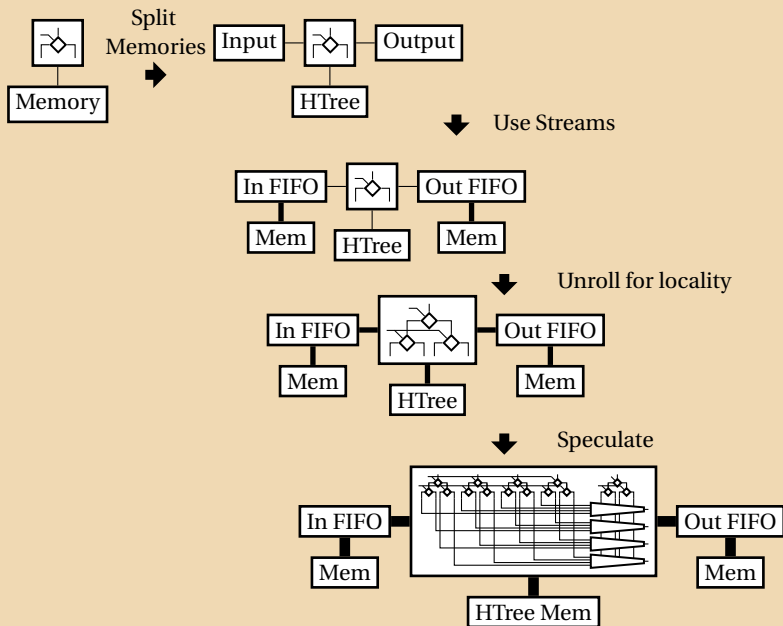

One Way to Encode the Types

Huffman tree nodes: (19 bits)

0	8-bit character	(unused)	Leaf Char
1	9-bit tree ptr.	9-bit tree ptr.	Branch Tree Tree

Boolean input stream: (10 bits)

0	(unused)	Nil	
1	bit	8-bit tail pointer	Cons Bool List

Character output stream: (19 bits)

0	(unused)	Nil	
1	8-bit character	10-bit tail pointer	Cons Char List

Intermediate Representation Desiderata

Mathematical formalism convenient for performing “parallelizing” transformations, a.k.a. parallel design patterns

- ▶ Pipeline
- ▶ Speculation
- ▶ Multiple workers
- ▶ Map-reduce

Intermediate Representation: Recursive “Islands”

program ::= *island**

island ::= **island** *name* *arg** = *expr* *state** Group of states w/ stack

state ::= *label* *arg** = *expr* Arguments & expression

expr ::= *name* *var** Apply a function

| **let** (*var* = *expr*)⁺ **in** *expr* Parallel evaluation

| **case** *var* **of** (*pattern* -> *expr*)⁺ Multiway conditional

| *var*

| *literal*

| **recurse** *label* *var** (*var**) Explicit continuation

| **return** *var*

| **goto** *label* *var** Branch to another state

pattern ::= *name* *var** | *literal* | _ Constructor/literal/def.

Huffman as a Recursive Island

```
data HTree = Branch HTree HTree  
         | Leaf Char
```

```
decode :: HTree -> [Bool] -> [Char]
```

```
decode table str = decoder table str
```

```
where
```

```
  decoder (Leaf s) i =  
    s : (decoder table i)  
  decoder _ [] = []  
  decoder (Branch f _) (False:xs) =  
    decoder f xs  
  decoder (Branch _ t) (True:xs) =  
    decoder t xs
```

```
island decoder treep ip =  
  let r = dec treep treep ip in return r
```

```
island dec treep statep ip =  
  let i = fetchi ip  
      state = fetcht statep in  
  case state of  
    Leaf a -> recurse s1 a (treep treep ip)  
    Branch f t ->  
      case i of  
        Nil -> let np = Nil in return np  
        Cons x xsp ->  
          case x of  
            True -> goto dec treep t xsp  
            False -> goto dec treep f xsp
```

```
s1 a rp = let rrp = Cons a rp  
           in return rrp
```

The Basic Translation Template

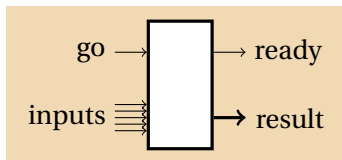

Strobe-based interface: *go* indicates inputs are valid; *ready* pulses once when result is valid.

Translating Let and Case

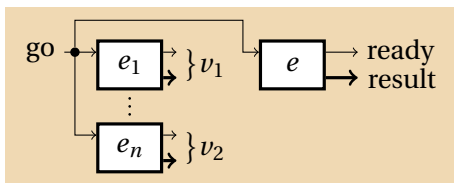

Let makes new values available to an expression.

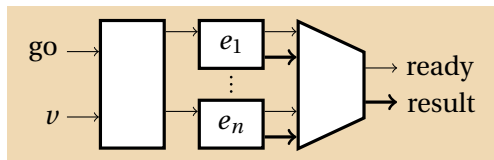

Case invokes one of its sub-expressions, then synchronizes.

Translating an Island

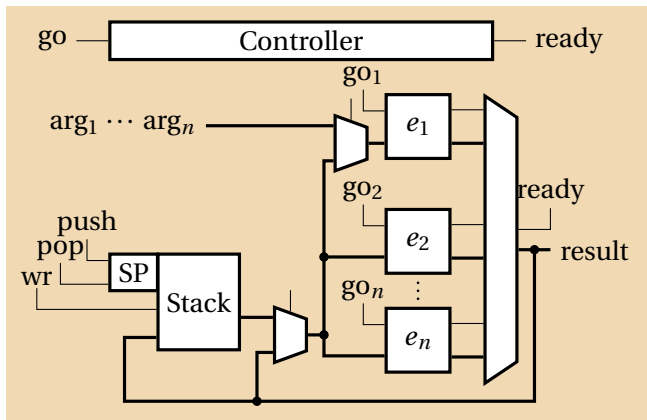

Each island consists of expressions for each state, its own stack, and a controller that manages the stack and invokes the states.

Constructors and Memory

A constructor is a function that stores data in memory.

$$\text{constructor } \alpha :: \alpha \rightarrow \text{Ptr } \alpha$$

Memory access functions turn pointers into data.

$$\text{fetch } \alpha :: \text{Ptr } \alpha \rightarrow \alpha$$

Memory stores return an address, not take one as an argument

Constructor is responsible for memory management.

By default, each data type gets its own memory.

Duplication for Performance

$$\mathit{fib} \ 0 = 0$$

$$\mathit{fib} \ 1 = 1$$

$$\mathit{fib} \ n = \mathit{fib} \ (n-1) + \mathit{fib} \ (n-2)$$

Duplication for Performance

$$\begin{aligned}fib\ 0 &= 0 \\fib\ 1 &= 1 \\fib\ n &= fib\ (n-1) + fib\ (n-2)\end{aligned}$$

After duplicating functions:

$$\begin{aligned}fib\ 0 &= 0 \\fib\ 1 &= 1 \\fib\ n &= fib'\ (n-1) + fib''\ (n-2)\end{aligned}$$

$$\begin{aligned}fib'\ 0 &= 0 \\fib'\ 1 &= 1 \\fib'\ n &= fib'\ (n-1) + fib'\ (n-2)\end{aligned}$$

$$\begin{aligned}fib''\ 0 &= 0 \\fib''\ 1 &= 1 \\fib''\ n &= fib''\ (n-1) + fib''\ (n-2)\end{aligned}$$

Here, fib' and fib'' may run in parallel.

Unrolling Recursive Data Structures

Like a “blocking factor,” but more general. Idea is to create larger memory blocks that can be operated on in parallel.

Original Huffman tree type:

```
data Htree = Branch Htree HTree | Leaf Char
```

Unrolled Huffman tree type:

```
data Htree = Branch Htree' HTree' | Leaf Char
```

```
data Htree' = Branch' Htree'' HTree'' | Leaf' Char
```

```
data Htree'' = Branch'' Htree HTree | Leaf'' Char
```

Recursive instances must be pointers; others can be explicit.

Functions must be similarly modified to work with the new types.

Acknowledgements

Project started while at MSR Cambridge



Satman Singh (now at Google)



Simon Peyton Jones (MSR)



Martha Kim (Columbia)

