

Audio and Other Waveforms

Stephen A. Edwards

Columbia University

Spring 2023

Waveforms

Time-varying scalar value

Commonly called a “signal” in the control-theory literature

Sound: air pressure over time

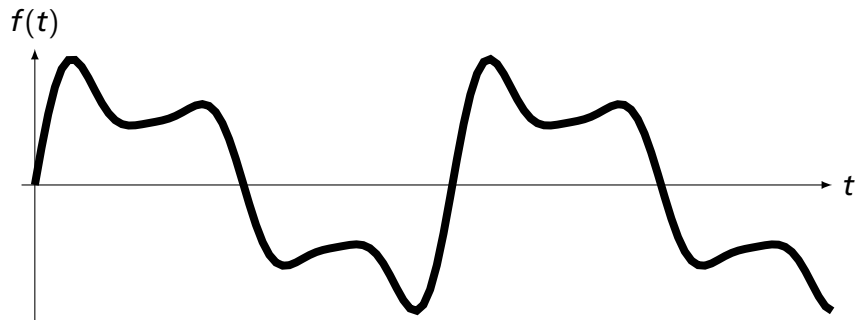

Raster video: brightness over time

Speed over time, position over time, etc.

The Fourier Series

Any periodic function can be expressed as a sum of harmonics

For a smooth function $f(t)$ with period T , i.e.,

$$f(t) = f(t + T),$$

there exists coefficients a_n, b_n such that

$$f(t) = a_0 + \sum_{m=1}^{\infty} a_m \cos \frac{2\pi mt}{T} + b_m \sin \frac{2\pi mt}{T}$$

The Fourier Series for a Square Wave

$$f(t) = \frac{4}{\pi} \left(\sin t \right)$$

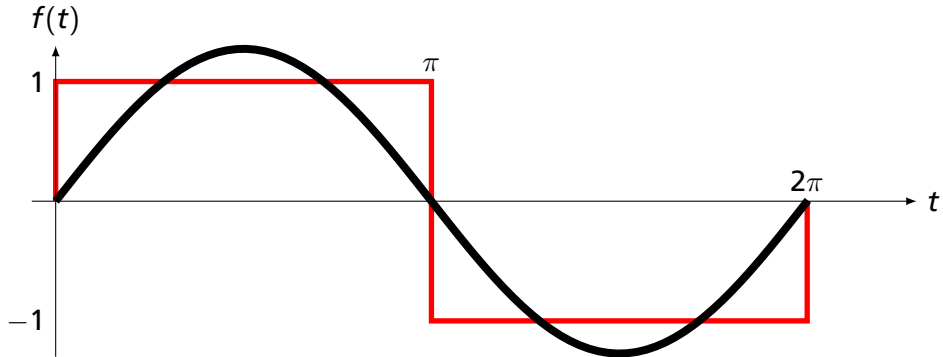

The Fourier Series for a Square Wave

$$f(t) = \frac{4}{\pi} \left(\sin t + \frac{\sin 3t}{3} \right)$$

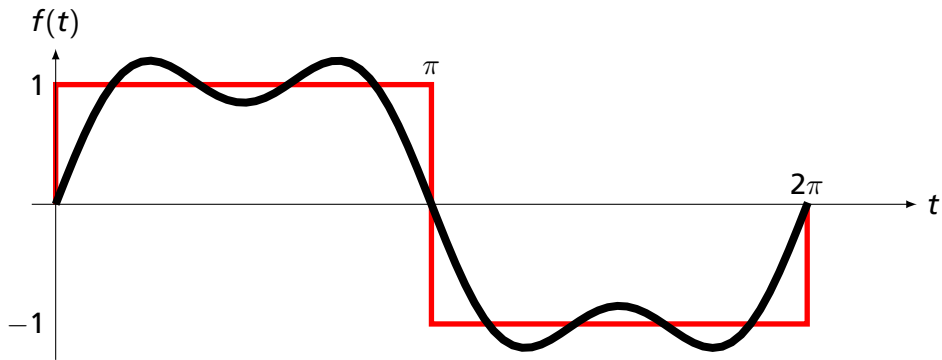

The Fourier Series for a Square Wave

$$f(t) = \frac{4}{\pi} \left(\sin t + \frac{\sin 3t}{3} + \frac{\sin 5t}{5} \right)$$

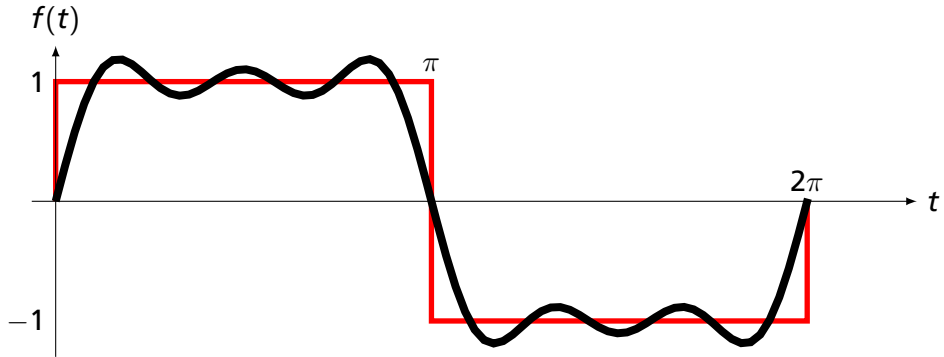

The Fourier Series for a Square Wave

$$f(t) = \frac{4}{\pi} \left(\sin t + \frac{\sin 3t}{3} + \frac{\sin 5t}{5} + \frac{\sin 7t}{7} \right)$$

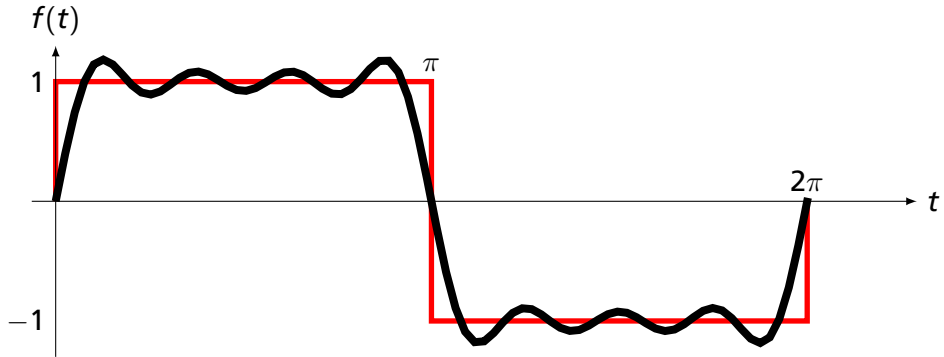

The Fourier Series for a Square Wave

$$f(t) = \frac{4}{\pi} \left(\sin t + \frac{\sin 3t}{3} + \frac{\sin 5t}{5} + \frac{\sin 7t}{7} + \frac{\sin 9t}{9} \right)$$

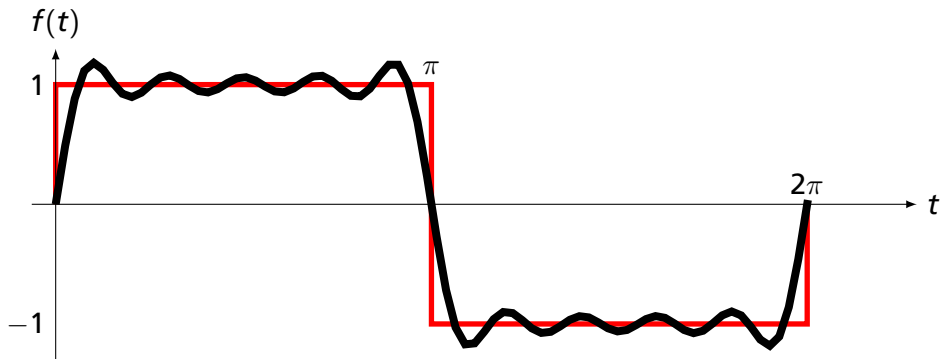

The Fourier Series for a Square Wave

$$f(t) = \frac{4}{\pi} \left(\sin t + \frac{\sin 3t}{3} + \frac{\sin 5t}{5} + \frac{\sin 7t}{7} + \frac{\sin 9t}{9} + \dots \right)$$

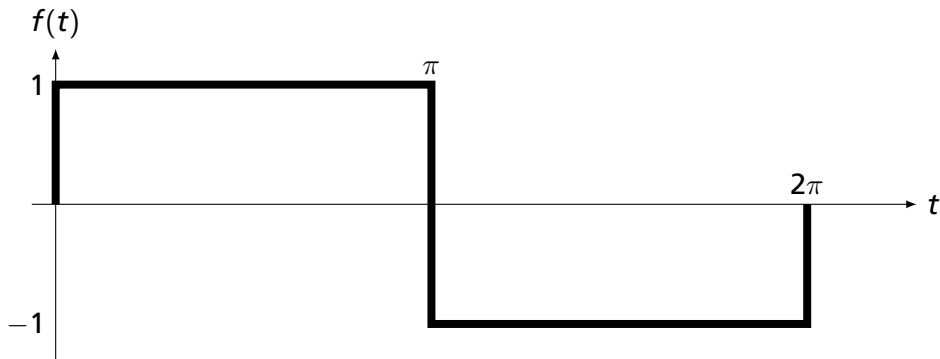

Bandwidth-Limited Signals

Basic observation: nothing changes infinitely fast

Bounding the rate of change sets the bandwidth of a signal

Hertz or Hz: "per second"

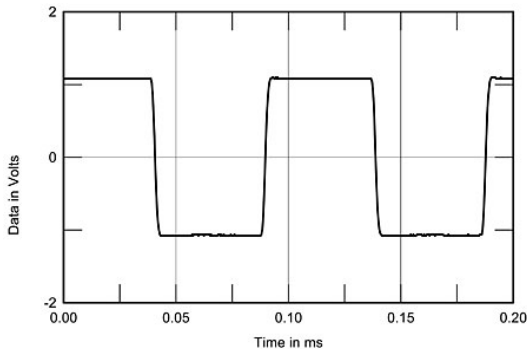

Source: Stereophile magazine: Marantz SM-11S1, A \$4000 audiophile amplifier rated 5 Hz–120 kHz. Small-signal 10kHz squarewave into 8 ohms.

The Bandwidth of Sound

Human ears are almost a Fourier transform

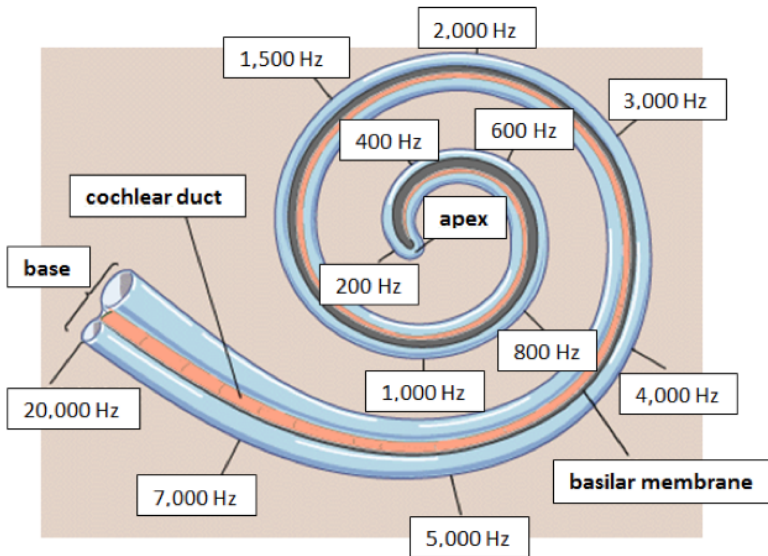

Human Hearing

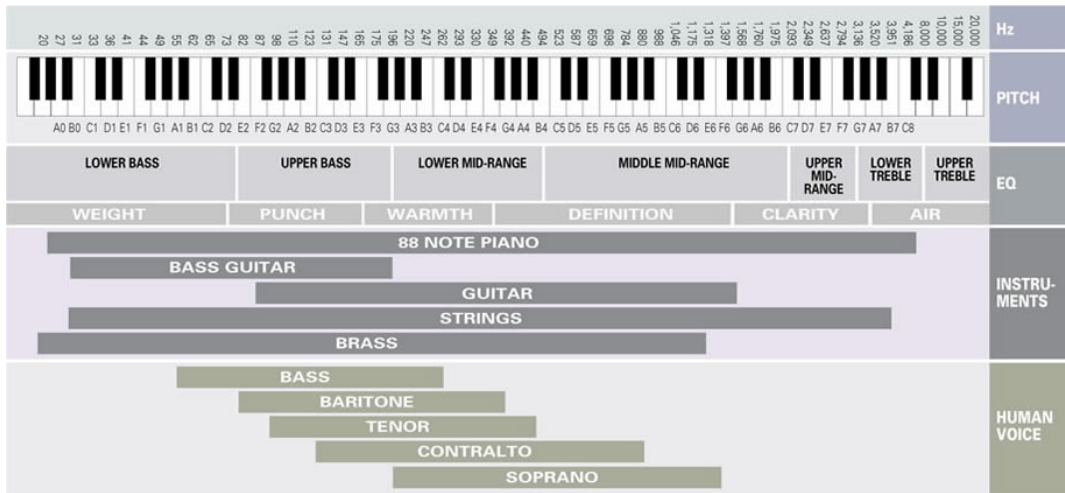

Empirically, humans hear 20 Hz–20 kHz

Highest frequency limit tends to decrease with age

Nyquist Theorem

To reconstruct a bandwidth-limited signal from samples, you need to sample at least twice the maximum frequency.

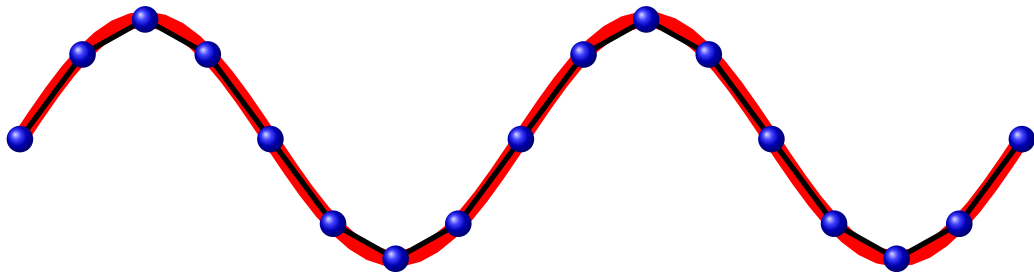

Sampling at $8 \times f$

Nyquist Theorem

To reconstruct a bandwidth-limited signal from samples, you need to sample at least twice the maximum frequency.

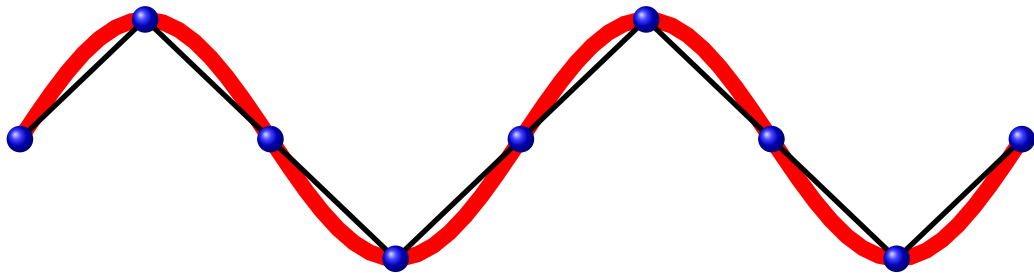

Sampling at $4 \times f$

Nyquist Theorem

To reconstruct a bandwidth-limited signal from samples, you need to sample at least twice the maximum frequency.

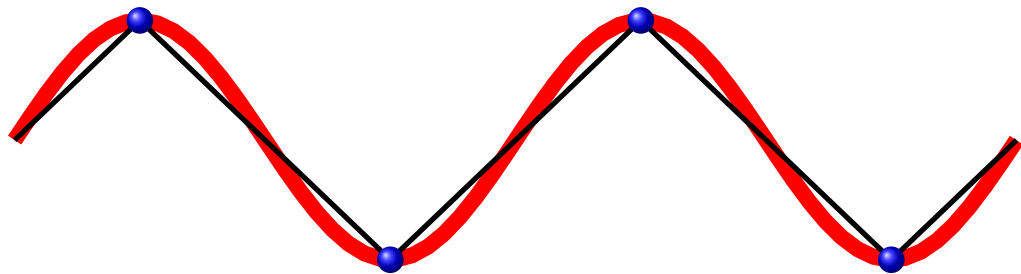

Sampling at $2 \times f$

Nyquist Theorem

To reconstruct a bandwidth-limited signal from samples, you need to sample at least twice the maximum frequency.

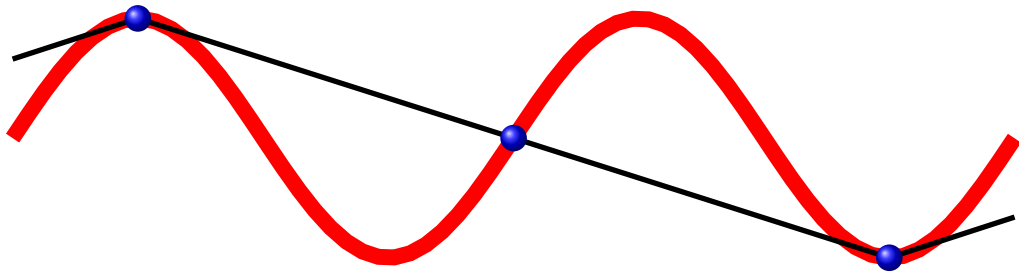

Sampling at $\frac{4}{3} \times f$

Nyquist Theorem

To reconstruct a bandwidth-limited signal from samples, you need to sample at least twice the maximum frequency.

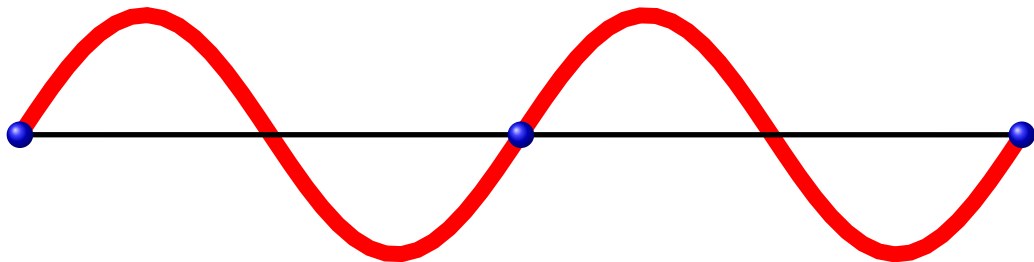

Sampling at $1 \times f$

Audio Sampling Rates

CD-quality audio: 44.1 kHz

Telephone-quality audio: 8 kHz

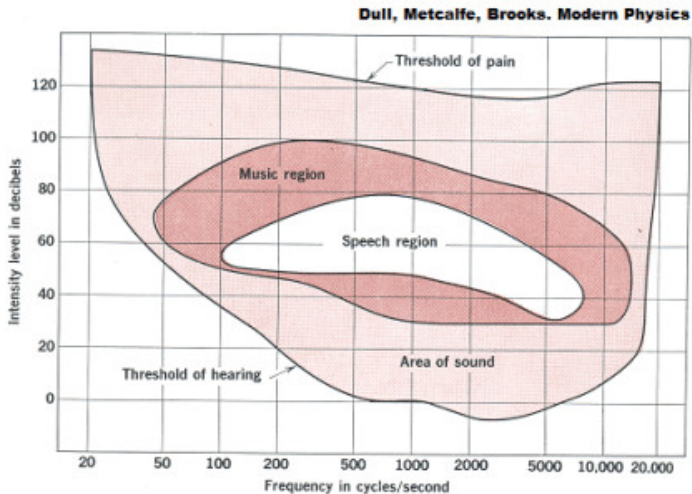

Signal-to-Noise Ratio

*You can't always get what you want
But if you try sometimes you might find
You get what you need*

—The Rolling Stones

Signals are never pure: there's always something that makes them deviate from the ideal.

Signal-to-Noise ratio:

$$SNR = \frac{\text{Signal Power}}{\text{Noise Power}}$$

Usually measured using a log scale, i.e.,

$$dB = 10 \log_{10} \frac{P_{\text{signal}}}{P_{\text{noise}}}$$

Human Hearing dB, SNR, and bits

Colt .45 Pistol (25 feet)	140
Threshold of Pain	130
	120
Underground Train	110
	100
Average Home Hi-Fi Level	90
Average Factory	80
	70
Average Conversation	60
	50
Average Office	40
Residential Ambient Noise	30
	20
Quiet Whisper (5 feet)	10
	0
Threshold of Hearing <i>0.0002 Dyne/Sq. cm</i>	

$$n \times 6.02 + 1.76 = \text{SNR in dB}$$

CD samples:

16 bits = 98 dB

Near the limit of human hearing

The CODEC on the DE1-SoC: Wolfson WM8731

enCOder/DECOder: analog-to-digital converter (ADC) + digital-to-analog converter (DAC)

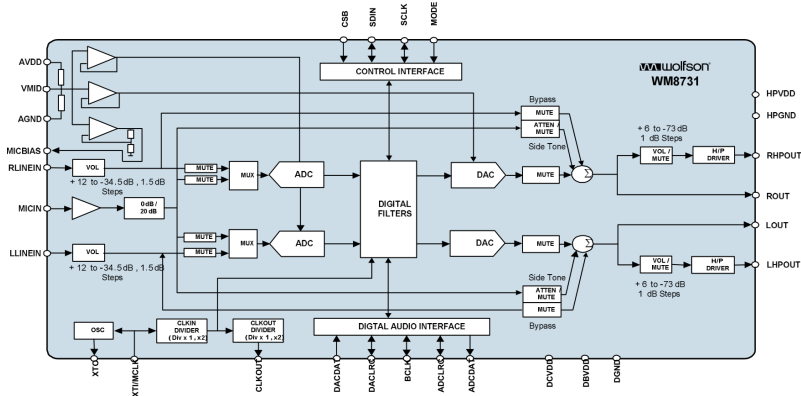

Two 24-bit ADCs; two 24-bit DACs + headphone amp

Sampling rates: 8 kHz – 96 kHz, 16–24 bit words

DE1-SoC Interface to the Audio Codec

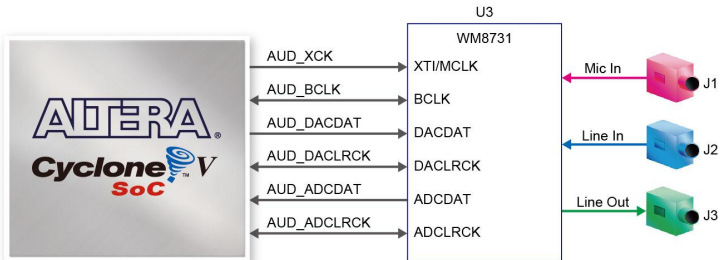

Pin Assignment of Audio CODEC

Signal Name	FPGA Pin No.	Description	I/O Standard
AUD_ADCLCK	PIN_K8	Audio CODEC ADC LR Clock	3.3V
AUD_ADCDAT	PIN_K7	Audio CODEC ADC Data	3.3V
AUD_DACLCK	PIN_H8	Audio CODEC DAC LR Clock	3.3V
AUD_DACDAT	PIN_J7	Audio CODEC DAC Data	3.3V
AUD_XCK	PIN_G7	Audio CODEC Chip Clock	3.3V
AUD_BCLK	PIN_H7	Audio CODEC Bit-stream Clock	3.3V
I2C_SCLK	PIN_J12 or PIN_E23	I2C Clock	3.3V
I2C_SDAT	PIN_K12 or PIN_C24	I2C Data	3.3V

I²C bus for configuration: data format, volume levels, etc.
Synchronous serial protocol (data + L/R + bit clock) for data

WM8731 Serial Protocol

One of four communication modes, set by I²C registers:

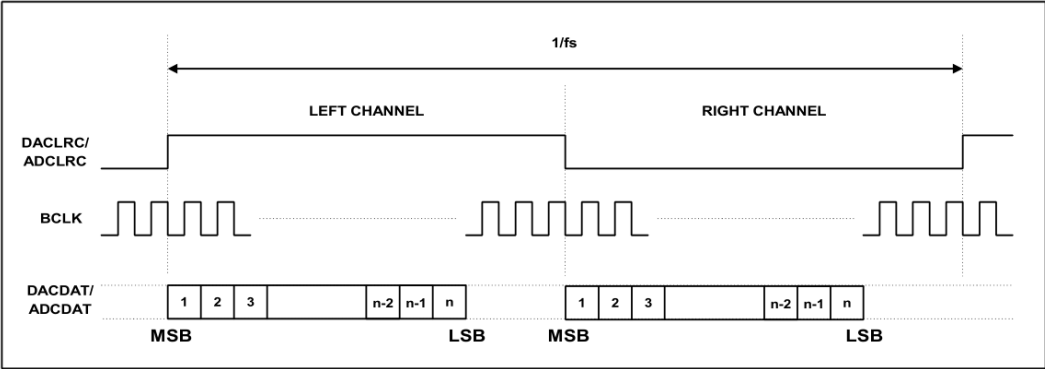
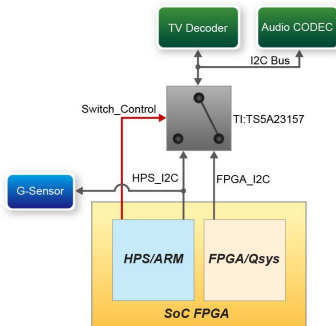

Figure 26 Left Justified Mode

DE1-SoC I²C Multiplexer



Control mechanism for the I²C multiplexer

Pin Assignment of I²C Bus

Signal Name	FPGA Pin No.	Description	I/O Standard
FPGA_I2C_SCLK	PIN_J12	FPGA I2C Clock	3.3V
FPGA_I2C_SDAT	PIN_K12	FPGA I2C Data	3.3V
HPS_I2C1_SCLK	PIN_E23	I2C Clock of the first HPS I2C concontroller	3.3V
HPS_I2C1_SDAT	PIN_C24	I2C Data of the first HPS I2C concontroller	3.3V
HPS_I2C2_SCLK	PIN_H23	I2C Clock of the second HPS I2C concontroller	3.3V
HPS_I2C2_SDAT	PIN_A25	I2C Data of the second HPS I2C concontroller	3.3V

Storing Waveforms

If you store each sample,

$$\frac{\text{samples}}{\text{second}} \times \frac{\text{bits}}{\text{sample}} \times \text{channels} = \frac{\text{bits}}{\text{second}}$$

Total memory consumption:

$$\frac{\text{bits}}{\text{seconds}} \times \text{seconds} = \text{bits}$$

E.g., CD-quality audio: 44.1 kHz, 16 bits/sample, 2 channels

$$44.1 \text{ kHz} \times 16 \times 2 = 1.4 \text{ Mbps} = 175 \text{ KB/s}$$

A 74-minute CD:

$$1.4 \text{ Mbps} \times 60 \frac{\text{seconds}}{\text{minute}} \times 74 \text{ minutes} \times \frac{\text{byte}}{8 \text{ bits}} = 783 \text{ MB}$$

Reducing Memory: Sample Less; Use Fewer Bits

74 minutes of CD-quality audio

(16 bits/sample, stereo, 44.1 kHz)

$$44.1 \text{ kHz} \times 32 \text{ bits} \times 60 \text{ sec/min} \times 74 \text{ min} \div 8 \text{ bits/byte} = 783 \text{ MB}$$

74 minutes of telephone-quality audio:

(8 bits/sample, mono, 8 kHz)

$$8 \text{ kHz} \times 8 \text{ bits} \times 60 \text{ sec/min} \times 74 \text{ min} \div 8 \text{ bits/byte} = 35 \text{ MB}$$

Reducing Memory: Lossy Compression (Compadding)

μ -law and A-law compression

Logarithmic encoding of 12 bit samples in 8 bits

Trades dynamic range for quantization noise

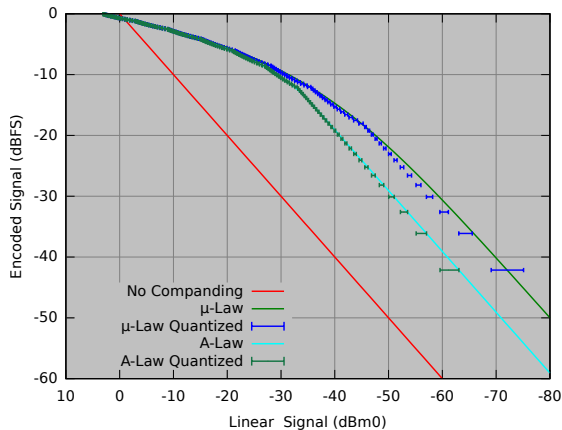

ADPCM: Adaptive Predictive Pulse Code Modulation

Uses 4 bits/sample to reconstruct 8-bit samples

Encodes the *difference* between the next sample and its predicted value

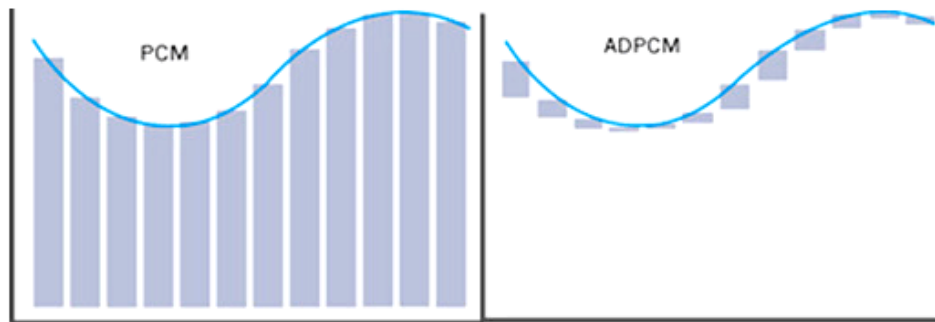

MPEG Layer 3 Compression: Perceptual Coding

Carefully reproduce what we hear well and worry less about what we can't (soft sounds masked by loud ones)

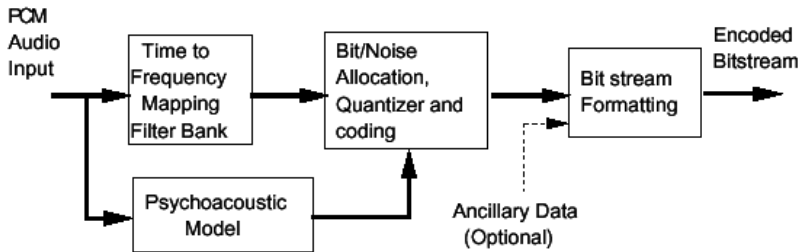
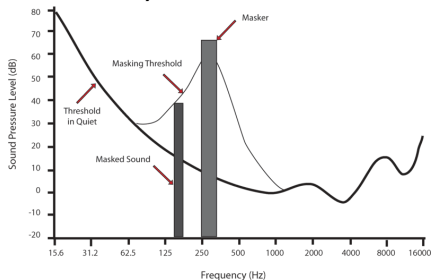

Sound Synthesis: Analog

Modular analog sound synthesis c. 1968

Oscillators + noise sources + envelope generators + filters



Moog synthesizer

Subtractive Synthesis

Start with a saw, square, or triangle wave, then filter

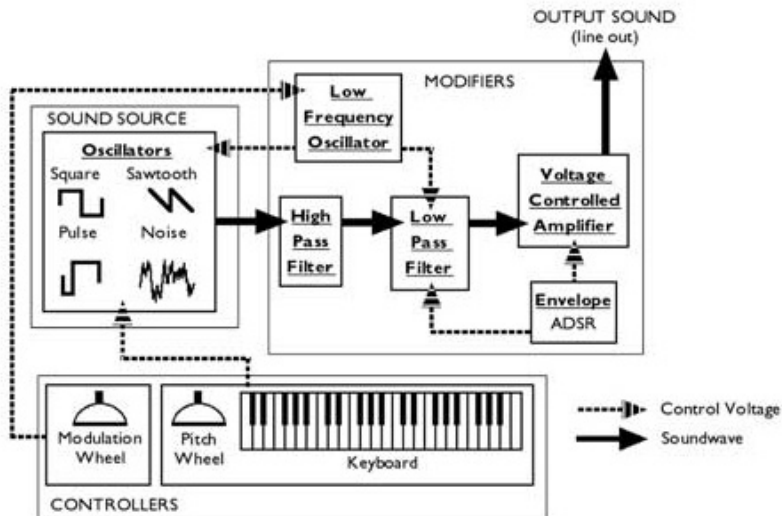

The AY-3-8912 Programmable Sound Generator

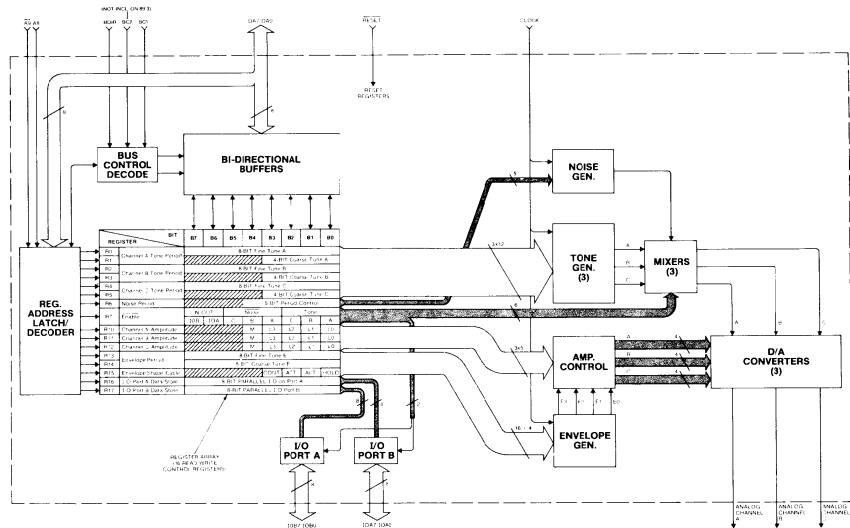

FM Synthesis

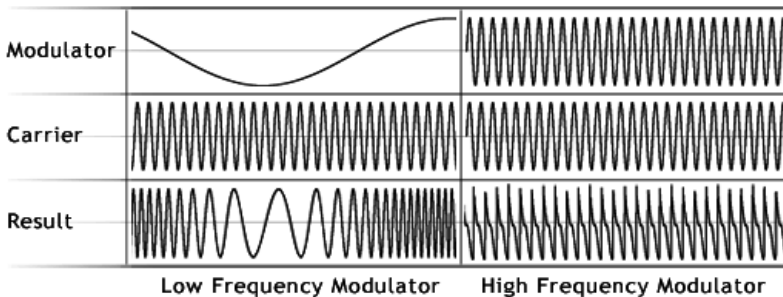

What does it sound like? Any pop music from the 1980s

Summary of Audio Waveform Generation

- Direct sampling (Pulse Code Modulation)
Consider sampling frequency, bits/sample
- Lossy Compression
Comping (μ-law, A-law)
ADPCM
Perceptual Coding (MP3 et al.)
- Synthesis
Subtractive (oscillators, filters, envelopes)
FM (Carrier × modulator, envelopes)
Wavetable/sampling (sound snippets + note events)

Representing Images

Same story; two dimensional waveforms

E.g., a single frame of VGA/standard definition television:

$$640 \times 480 \times 24 \frac{\text{bits}}{\text{pixel}} = 900 \text{ KB}$$

HD is terrifying:

$$1920 \times 1080 \times 24 \frac{\text{bits}}{\text{pixel}} = 5.9 \text{ MB}$$

JPEG: Still Image Compression

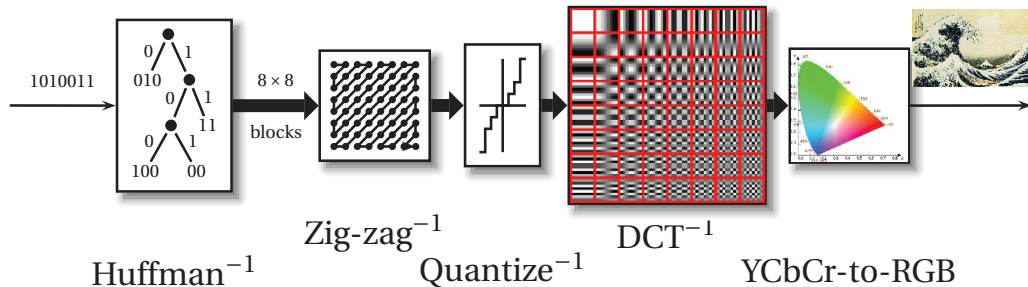

Colorspace conversion

Space-to-frequency domain conversion

Quantization

Zig-zag encoding

Huffman encoding