

Review for the Final

Stephen A. Edwards

Columbia University

Summer 2015

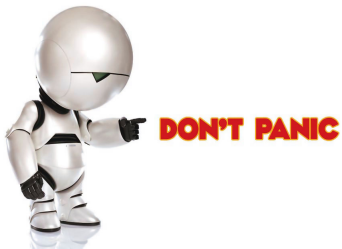

Table of Contents I

The Final

Structure of a Compiler

Scanning

- Languages and Regular Expressions

- NFAs

- Translating REs into NFAs

- Building a DFA from an NFA: Subset Construction

Parsing

- Resolving Ambiguity

- Rightmost and Reverse-Rightmost Derivations

- Building the LR(0) Automaton

- Building an SLR Parsing Table

- Shift/Reduce Parsing

Table of Contents II

Types and Static Semantics

- Static Semantic Analysis

- Scope

- Applicative vs. Normal-Order Evaluation

Runtime Environments

- Storage Classes and Memory Layout

- The Stack and Activation Records

- In-Memory Layout Issues

- The Heap

- Automatic Garbage Collection

- Objects and Inheritance

- Exceptions

Table of Contents III

Code Generation

- Intermediate Representations

- Optimization and Basic Blocks

- Separate Compilation and Linking

The Lambda Calculus

- Lambda Expressions

- Beta-reduction

- Alpha-conversion

- Reduction Order

- Normal Form

- The Y Combinator

Table of Contents IV

Logic Programming in Prolog

- Prolog Execution

- The Prolog Environment

- Unification

- The Searching Algorithm

- Prolog as an Imperative Language

Parallel Programming in OpenMP

- Processes vs. Threads

- OpenMP

- The Fork-Join Task Model

- Parallel Regions

- The For Construct

- Critical Regions

- Reduction

- Barriers

The Final

120 minutes

Closed book

One double-sided sheet of notes of your own devising

Comprehensive: Anything discussed in class is fair game, including things from before the midterm

Little, if any, programming

Details of O'Caml/C/C++/Java syntax not required

Broad knowledge of languages discussed

Compiling a Simple Program

```
int gcd(int a, int b)
{
    while (a != b) {
        if (a > b) a -= b;
        else b -= a;
    }
    return a;
}
```

What the Compiler Sees

```
int gcd(int a, int b)
{
    while (a != b) {
        if (a > b) a -= b;
        else b -= a;
    }
    return a;
}
```

```
i n t s p g c d ( i n t s p a , s p i
n t s p b ) n l { n l s p s p w h i l e s p
( a s p ! = s p b ) s p { n l s p s p s p s p i
f s p ( a s p > s p b ) s p a s p - = s p b
; n l s p s p s p e l s e s p b s p - = s p
a ; n l s p s p } n l s p s p r e t u r n s p
a ; n l } n l
```

Text file is a sequence of characters

Lexical Analysis Gives Tokens

```
int gcd(int a, int b)
{
  while (a != b) {
    if (a > b) a -= b;
    else b -= a;
  }
  return a;
}
```



int	gcd	(int	a	,	int	b)	{	while	(a		
!=	b)	{	if	(a	>	b)	a	-=	b	;	else
b	-=	a	;	}	return	a	;	}						

A stream of tokens. Whitespace, comments removed.

Parsing Gives an Abstract Syntax Tree

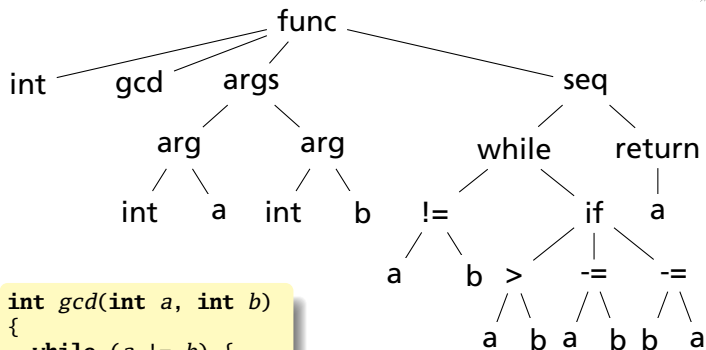

```
int gcd(int a, int b)
{
    while (a != b) {
        if (a > b) a -= b;
        else b -= a;
    }
    return a;
}
```

Semantic Analysis Resolves Symbols and Checks Types

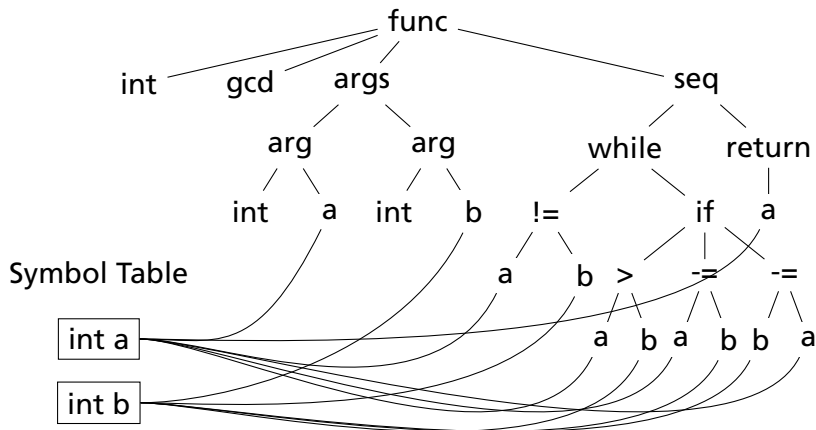

Translation into 3-Address Code

```
L0: sne    $1, a, b
     seq   $0, $1, 0
     btrue $0, L1    # while (a != b)
     sl    $3, b, a
     seq   $2, $3, 0
     btrue $2, L4    # if (a < b)
     sub   a, a, b # a -= b
     jmp   L5
L4: sub   b, b, a # b -= a
L5: jmp   L0
L1: ret   a
```

```
int gcd(int a, int b)
{
  while (a != b) {
    if (a > b) a -= b;
    else b -= a;
  }
  return a;
}
```

Idealized assembly language w/
infinite registers

Generation of 80386 Assembly

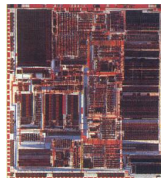

```
gcd:  pushl  %ebp          # Save BP
      movl  %esp,%ebp
      movl  8(%ebp),%eax  # Load a from stack
      movl  12(%ebp),%edx # Load b from stack
.L8:  cmpl  %edx,%eax
      je   .L3           # while (a != b)
      jle .L5           # if (a < b)
      subl %edx,%eax    # a -= b
      jmp .L8
.L5:  subl %eax,%edx    # b -= a
      jmp .L8
.L3:  leave          # Restore SP, BP
      ret
```

Describing Tokens

Alphabet: A finite set of symbols

Examples: $\{ 0, 1 \}$, $\{ A, B, C, \dots, Z \}$, ASCII, Unicode

String: A finite sequence of symbols from an alphabet

Examples: ϵ (the empty string), Stephen, $\alpha\beta\gamma$

Language: A set of strings over an alphabet

Examples: \emptyset (the empty language), $\{ 1, 11, 111, 1111 \}$, all English words, strings that start with a letter followed by any sequence of letters and digits

Operations on Languages

Let $L = \{ \epsilon, wo \}$, $M = \{ man, men \}$

Concatenation: Strings from one followed by the other

$LM = \{ man, men, woman, women \}$

Union: All strings from each language

$L \cup M = \{ \epsilon, wo, man, men \}$

Kleene Closure: Zero or more concatenations

$M^* = \{ \epsilon \} \cup M \cup MM \cup MMM \dots =$
 $\{ \epsilon, man, men, manman, manmen, menman, menmen,$
 $manmanman, manmanmen, manmenman, \dots \}$

Regular Expressions over an Alphabet Σ

A standard way to express languages for tokens.

1. ϵ is a regular expression that denotes $\{\epsilon\}$
2. If $a \in \Sigma$, a is an RE that denotes $\{a\}$
3. If r and s denote languages $L(r)$ and $L(s)$,
 - ▶ $(r) | (s)$ denotes $L(r) \cup L(s)$
 - ▶ $(r)(s)$ denotes $\{tu : t \in L(r), u \in L(s)\}$
 - ▶ $(r)^*$ denotes $\cup_{i=0}^{\infty} L^i$ ($L^0 = \{\epsilon\}$ and $L^i = LL^{i-1}$)

Nondeterministic Finite Automata

"All strings containing an even number of 0's and 1's"

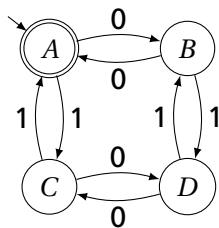

1. Set of states

$$S: \left\{ \textcircled{\textcircled{A}} \textcircled{B} \textcircled{C} \textcircled{D} \right\}$$

2. Set of input symbols $\Sigma: \{0, 1\}$

3. Transition function $\sigma: S \times \Sigma_c \rightarrow 2^S$

state	ϵ	0	1
A	\emptyset	{B}	{C}
B	\emptyset	{A}	{D}
C	\emptyset	{D}	{A}
D	\emptyset	{C}	{B}

4. Start state $s_0: \textcircled{\textcircled{A}}$

5. Set of accepting states

$$F: \left\{ \textcircled{\textcircled{A}} \right\}$$

The Language induced by an NFA

An NFA accepts an input string x iff there is a path from the start state to an accepting state that “spells out” x .

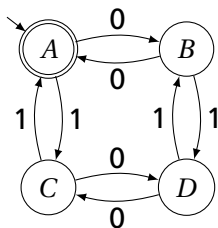

Show that the string “010010” is accepted.

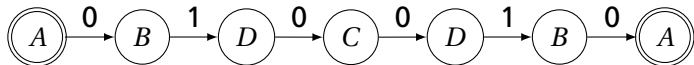

Translating REs into NFAs

a



Symbol

$r_1 r_2$

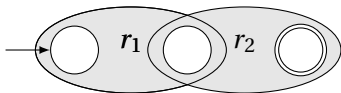

Sequence

$r_1 | r_2$

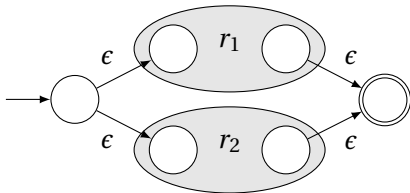

Choice

$(r)^*$

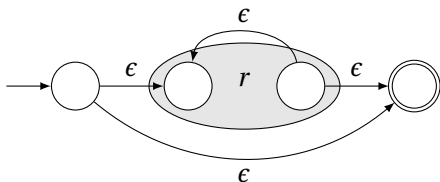

Kleene Closure

Translating REs into NFAs

Example: Translate $(a|b)^*abb$ into an NFA. Answer:

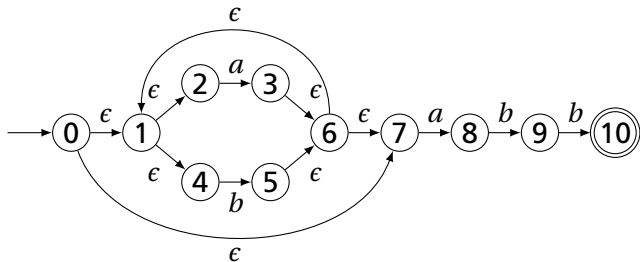

Show that the string "aabb" is accepted. Answer:

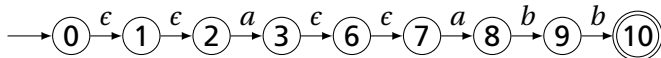

Simulating NFAs

Problem: you must follow the “right” arcs to show that a string is accepted. How do you know which arc is right?

Solution: follow them all and sort it out later.

“Two-stack” NFA simulation algorithm:

1. Initial states: the ϵ -closure of the start state
2. For each character c ,
 - ▶ New states: follow all transitions labeled c
 - ▶ Form the ϵ -closure of the current states
3. Accept if any final state is accepting

Simulating an NFA: $\cdot aabb$, Start

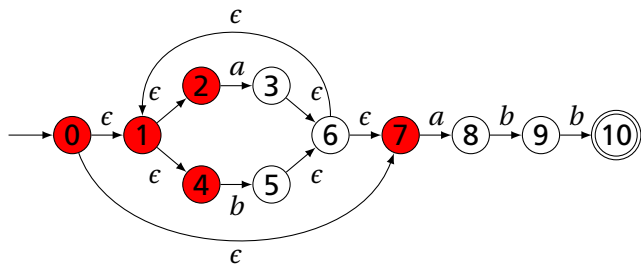
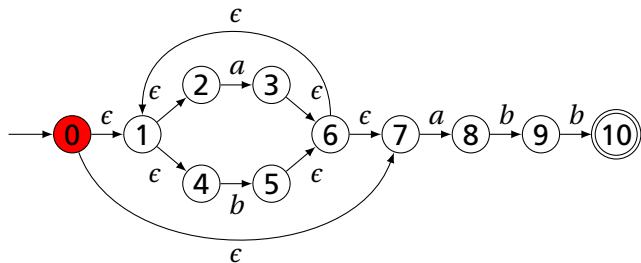

Simulating an NFA: $a \cdot abb$

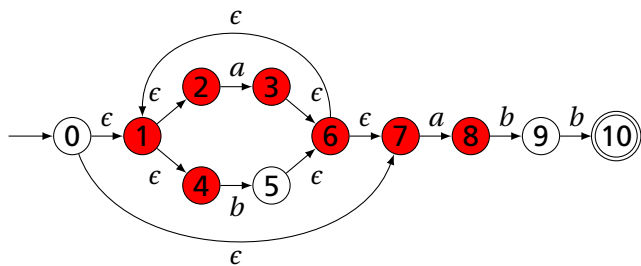
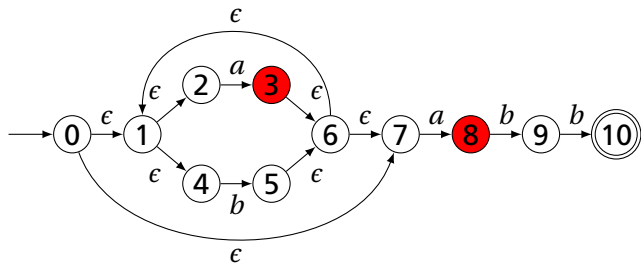

Simulating an NFA: $aa \cdot bb$

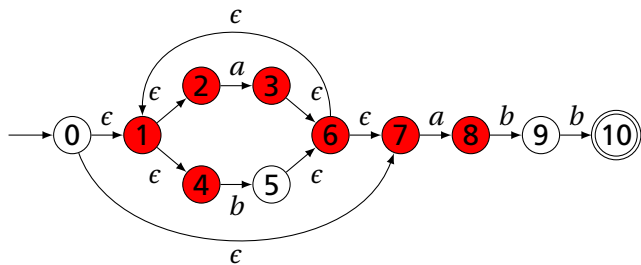
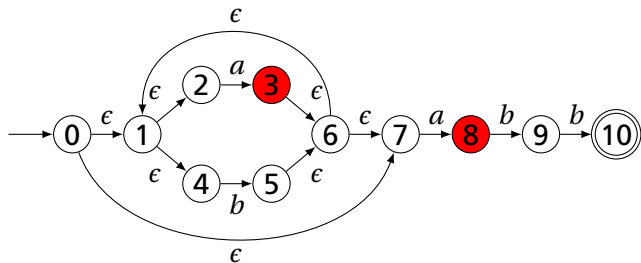

Simulating an NFA: $aab \cdot b$

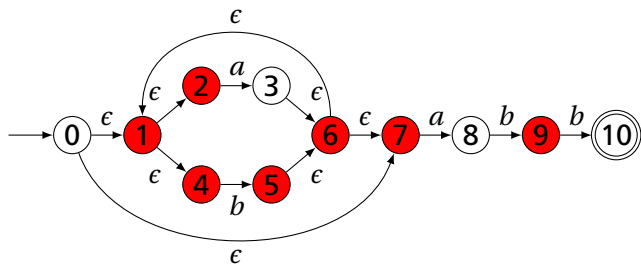
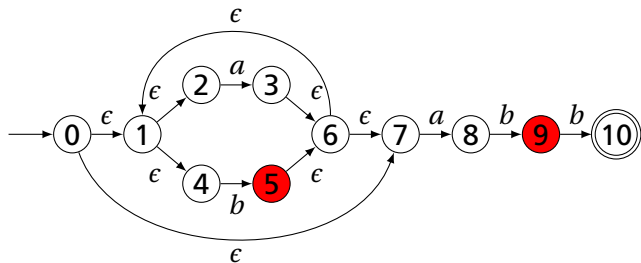

Simulating an NFA: *aabb*., Done

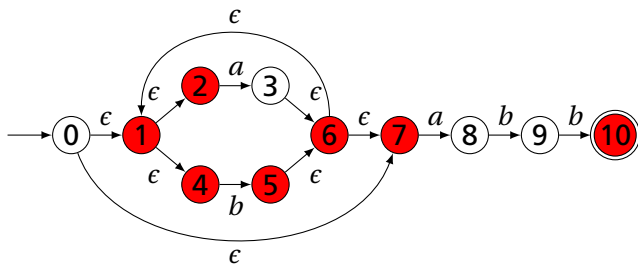
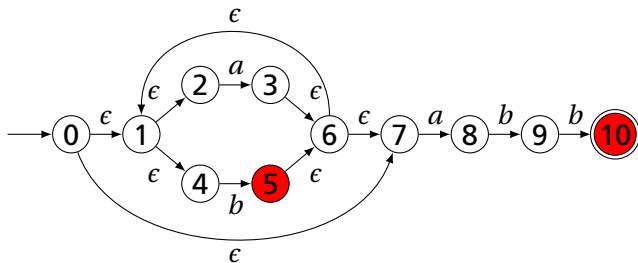

Deterministic Finite Automata

Restricted form of NFAs:

- ▶ No state has a transition on ϵ
- ▶ For each state s and symbol a , there is at most one edge labeled a leaving s .

Differs subtly from the definition used in COMS W3261
(Sipser, *Introduction to the Theory of Computation*)

Very easy to check acceptance: simulate by maintaining current state. Accept if you end up on an accepting state. Reject if you end on a non-accepting state or if there is no transition from the current state for the next symbol.

Deterministic Finite Automata

```
{  
  type token = ELSE | ELSEIF  
}
```

```
rule token =  
  parse "else"  { ELSE }  
  | "elseif" { ELSEIF }
```

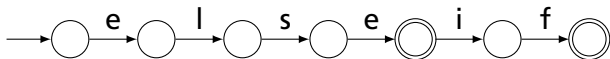

Deterministic Finite Automata

```
{ type token = IF | ID of string | NUM of string }
```

```
rule token =
```

```
  parse "if"
```

```
    | ['a'-'z'] ['a'-'z' '0'-'9']* as lit { ID(lit) }
```

```
    | ['0'-'9']+ as num { NUM(num) }
```

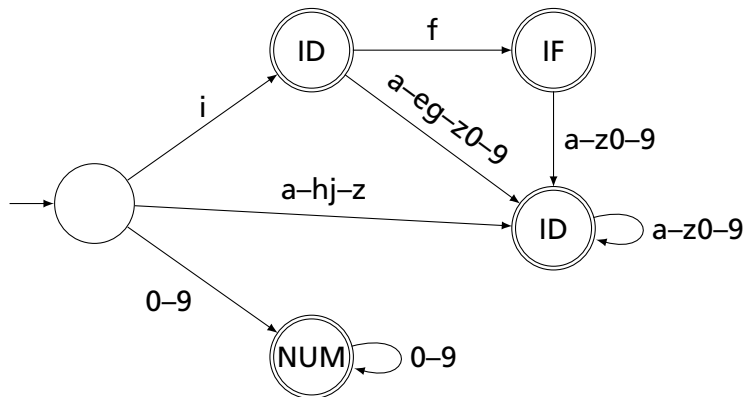

Building a DFA from an NFA

Subset construction algorithm

Simulate the NFA for all possible inputs and track the states that appear.

Each unique state during simulation becomes a state in the DFA.

Subset construction for $(a | b)^* abb$

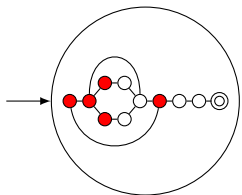

Subset construction for $(a|b)^*abb$

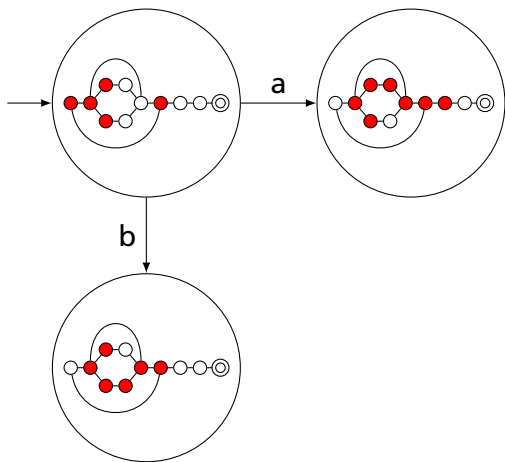

Subset construction for $(a|b)^*abb$

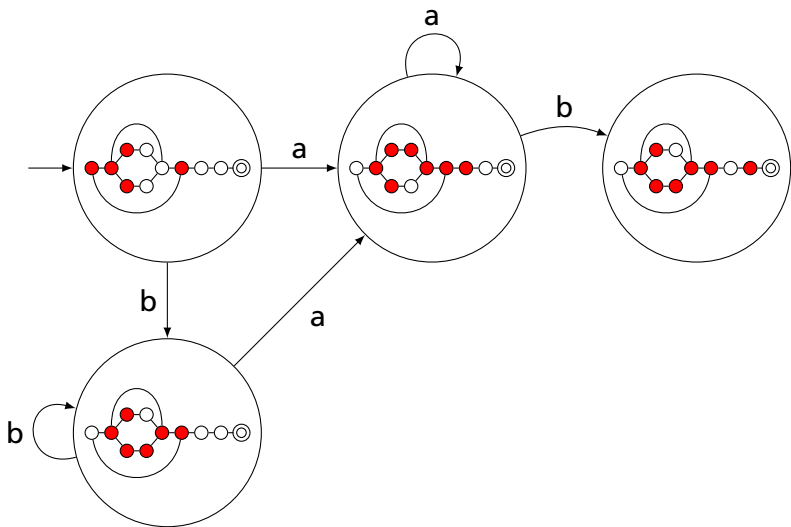

Subset construction for $(a|b)^*abb$

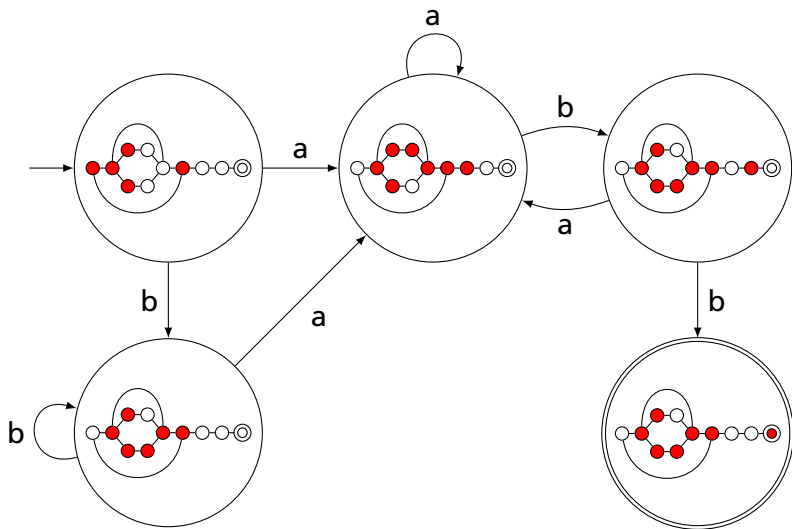

Subset construction for $(a|b)^*abb$

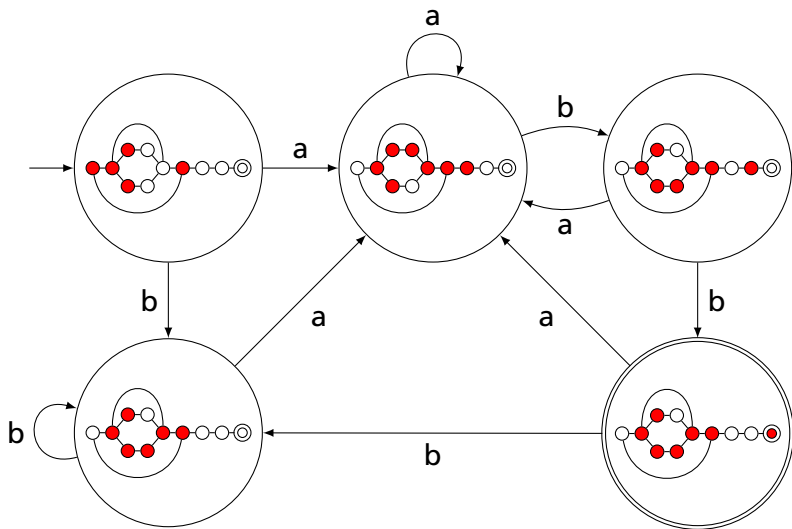

Result of subset construction for $(a|b)^*abb$

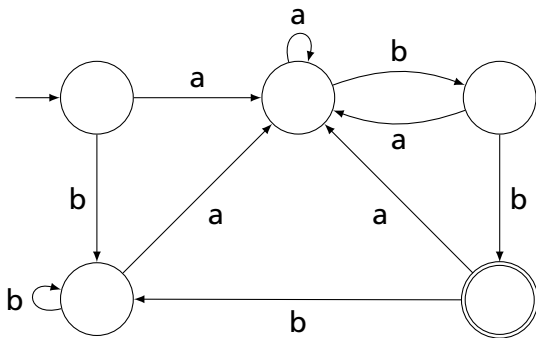

Is this minimal?

Ambiguous Arithmetic

Ambiguity can be a problem in expressions. Consider parsing

$$3 - 4 * 2 + 5$$

with the grammar

$$e \rightarrow e + e \mid e - e \mid e * e \mid e / e \mid N$$

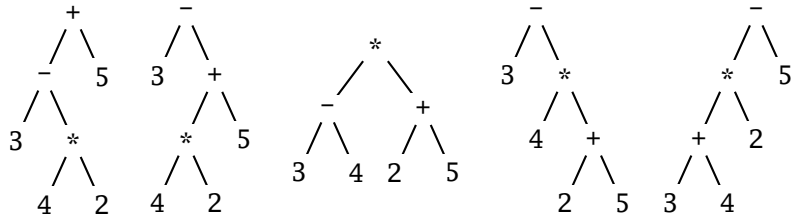

Operator Precedence

Defines how "sticky" an operator is.

$$1 * 2 + 3 * 4$$

* at higher precedence than +:

$$(1 * 2) + (3 * 4)$$

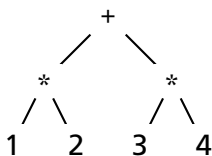

+ at higher precedence than *:

$$1 * (2 + 3) * 4$$

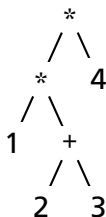

Associativity

Whether to evaluate left-to-right or right-to-left

Most operators are left-associative

$$1 - 2 - 3 - 4$$

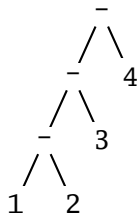

$$((1 - 2) - 3) - 4$$

left associative

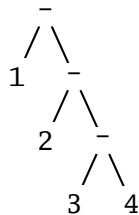

$$1 - (2 - (3 - 4))$$

right associative

Fixing Ambiguous Grammars

A grammar specification:

```
expr :  
    expr PLUS expr  
    | expr MINUS expr  
    | expr TIMES expr  
    | expr DIVIDE expr  
    | NUMBER
```

Ambiguous: no precedence or associativity.

Ocamlyacc's complaint: "16 shift/reduce conflicts."

Assigning Precedence Levels

Split into multiple rules, one per level

```
expr : expr PLUS expr  
      | expr MINUS expr  
      | term  
  
term : term TIMES term  
      | term DIVIDE term  
      | atom  
  
atom : NUMBER
```

Still ambiguous: associativity not defined

Ocamlyacc's complaint: "8 shift/reduce conflicts."

Assigning Associativity

Make one side the next level of precedence

```
expr : expr PLUS term  
      | expr MINUS term  
      | term  
  
term : term TIMES atom  
      | term DIVIDE atom  
      | atom  
  
atom : NUMBER
```

This is left-associative.

No shift/reduce conflicts.

Rightmost Derivation of $\text{Id} * \text{Id} + \text{Id}$

1: $e \rightarrow t + e$

2: $e \rightarrow t$

3: $t \rightarrow \text{Id} * t$

4: $t \rightarrow \text{Id}$

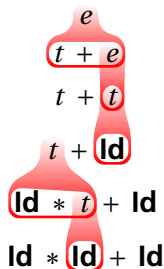

At each step, expand the *rightmost* nonterminal.

nonterminal

“handle”: The right side of a production

Fun and interesting fact: there is exactly one rightmost expansion if the grammar is unambiguous.

Rightmost Derivation: What to Expand

1: $e \rightarrow t + e$

2: $e \rightarrow t$

3: $t \rightarrow \mathbf{Id} * t$

4: $t \rightarrow \mathbf{Id}$

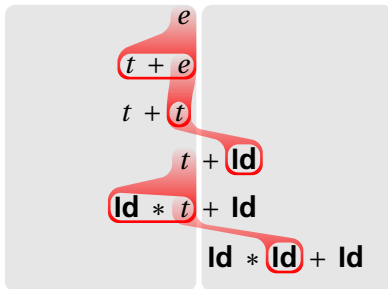
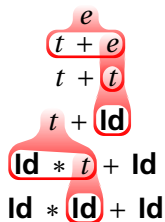

Expand here ↑ Terminals only

Reverse Rightmost Derivation

1: $e \rightarrow t + e$

2: $e \rightarrow t$

3: $t \rightarrow \text{Id} * t$

4: $t \rightarrow \text{Id}$

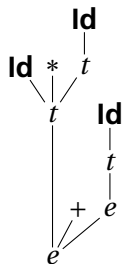
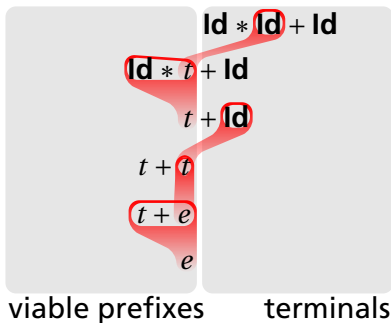
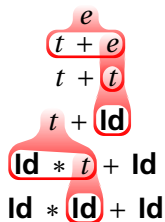

Shift/Reduce Parsing Using an Oracle

1: $e \rightarrow t + e$

2: $e \rightarrow t$

3: $t \rightarrow \text{Id} * t$

4: $t \rightarrow \text{Id}$

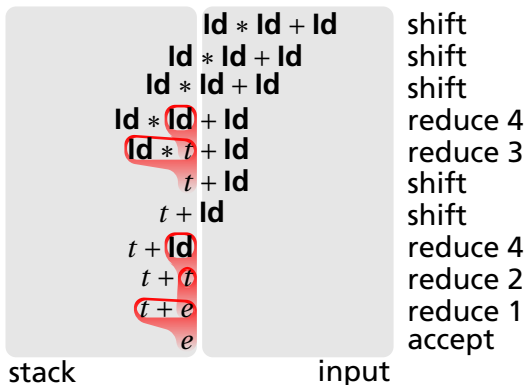
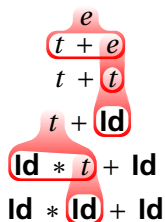

Handle Hunting

Right Sentential Form: any step in a rightmost derivation

Handle: in a sentential form, a RHS of a rule that, when rewritten, yields the previous step in a rightmost derivation.

The big question in shift/reduce parsing:

When is there a handle on the top of the stack?

Enumerate all the right-sentential forms and pattern-match against them? *Usually infinite in number, but let's try anyway.*

The Handle-Identifying Automaton

Magical result, due to Knuth: *An automaton suffices to locate a handle in a right-sentential form.*

$\text{Id} * \text{Id} * \dots * \text{Id} * t \dots$
 $\text{Id} * \text{Id} * \dots * \text{Id} \dots$
 $t + t + \dots + t + e$
 $t + t + \dots + t + \text{Id}$
 $t + t + \dots + t + \text{Id} * \text{Id} * \dots * \text{Id} * t$
 $t + t + \dots + t$

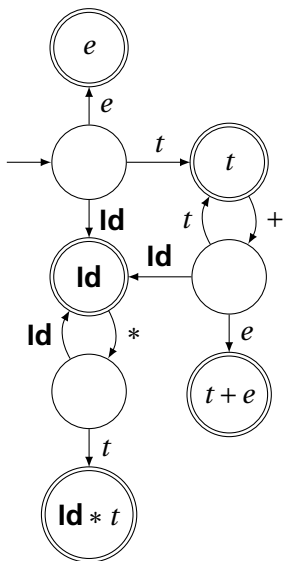

Building the Initial State of the LR(0) Automaton

$$e' \rightarrow \cdot e$$

$$1: e \rightarrow t + e$$

$$2: e \rightarrow t$$

$$3: t \rightarrow \mathbf{ld} * t$$

$$4: t \rightarrow \mathbf{ld}$$

Key idea: automata identify viable prefixes of right sentential forms. Each state is an equivalence class of possible places in productions.

At the beginning, any viable prefix must be at the beginning of a string expanded from e . We write this condition " $e' \rightarrow \cdot e$ "

Building the Initial State of the LR(0) Automaton

1: $e \rightarrow t + e$

2: $e \rightarrow t$

3: $t \rightarrow \mathbf{ld} * t$

4: $t \rightarrow \mathbf{ld}$

$$e' \rightarrow \cdot e$$
$$e \rightarrow \cdot t + e$$
$$e \rightarrow \cdot t$$

Key idea: automata identify viable prefixes of right sentential forms. Each state is an equivalence class of possible places in productions.

At the beginning, any viable prefix must be at the beginning of a string expanded from e . We write this condition " $e' \rightarrow \cdot e$ "

There are two choices for what an e may expand to: $t + e$ and t . So when $e' \rightarrow \cdot e$, $e \rightarrow \cdot t + e$ and $e \rightarrow \cdot t$ are also true, i.e., it must start with a string expanded from t .

Building the Initial State of the LR(0) Automaton

1: $e \rightarrow t + e$

2: $e \rightarrow t$

3: $t \rightarrow \mathbf{ld} * t$

4: $t \rightarrow \mathbf{ld}$

$$e' \rightarrow \cdot e$$
$$e \rightarrow \cdot t + e$$
$$e \rightarrow \cdot t$$
$$t \rightarrow \cdot \mathbf{ld} * t$$
$$t \rightarrow \cdot \mathbf{ld}$$

Key idea: automata identify viable prefixes of right sentential forms. Each state is an equivalence class of possible places in productions.

At the beginning, any viable prefix must be at the beginning of a string expanded from e . We write this condition " $e' \rightarrow \cdot e$ "

There are two choices for what an e may expand to: $t + e$ and t . So when $e' \rightarrow \cdot e$, $e \rightarrow \cdot t + e$ and $e \rightarrow \cdot t$ are also true, i.e., it must start with a string expanded from t .

Similarly, t must be either $\mathbf{ld} * t$ or \mathbf{ld} , so $t \rightarrow \cdot \mathbf{ld} * t$ and $t \rightarrow \cdot \mathbf{ld}$.

Building the LR(0) Automaton

The first state suggests a viable prefix can start as any string derived from e , any string derived from t , or **ld**.

$$e' \rightarrow \cdot e$$

$$e \rightarrow \cdot t + e$$

$$\mathbf{S0} : e \rightarrow \cdot t$$

$$t \rightarrow \cdot \mathbf{ld} * t$$

$$t \rightarrow \cdot \mathbf{ld}$$

Building the LR(0) Automaton

*"Just passed
a string de-
rived from
e"*

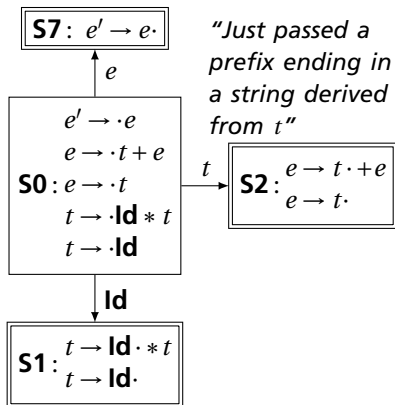

*"Just passed a
prefix ending in
a string derived
from t"*

The first state suggests a viable prefix can start as any string derived from e , any string derived from t , or ld .

The items for these three states come from advancing the \cdot across each thing, then performing the closure operation (vacuous here).

*"Just passed a
prefix that ended
in an ld"*

Building the LR(0) Automaton

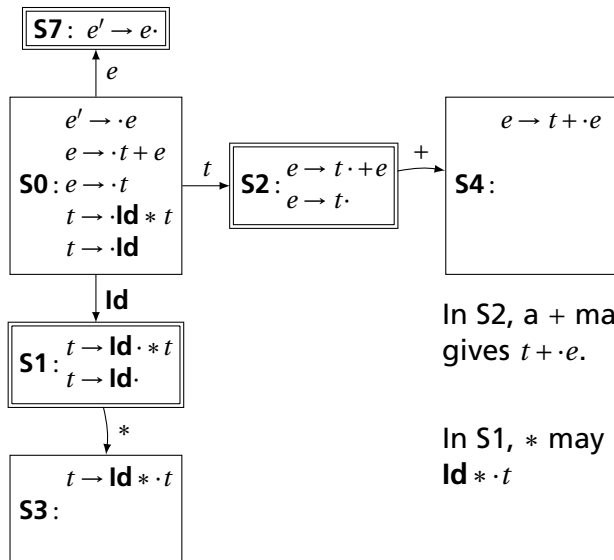

In S2, a + may be next. This gives $t + \cdot e$.

In S1, * may be next, giving $\text{ld} * \cdot t$

Building the LR(0) Automaton

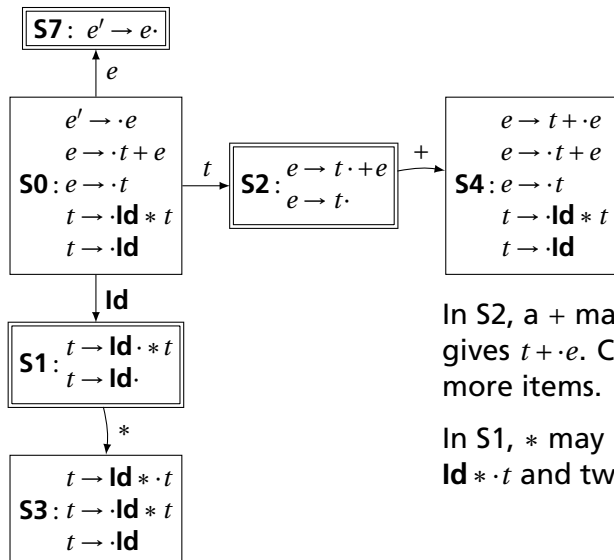

In S2, a + may be next. This gives $t + \cdot e$. Closure adds 4 more items.

In S1, * may be next, giving $\text{ld} * \cdot t$ and two others.

Building the LR(0) Automaton

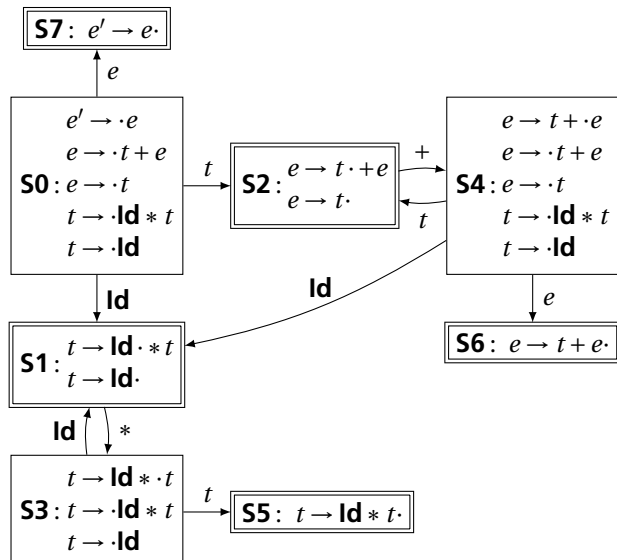

Converting the LR(0) Automaton to an SLR Parsing Table

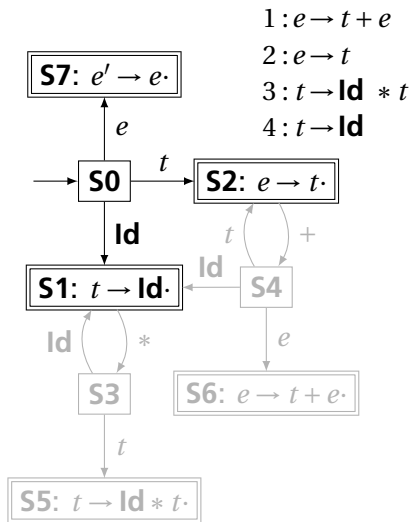

State	Action				Goto	
	Id	+	*	\$	e	t
0	s1				7	2

From S0, shift an **Id** and go to S1;
or cross a **t** and go to S2;
or cross an **e** and go to S7.

Converting the LR(0) Automaton to an SLR Parsing Table

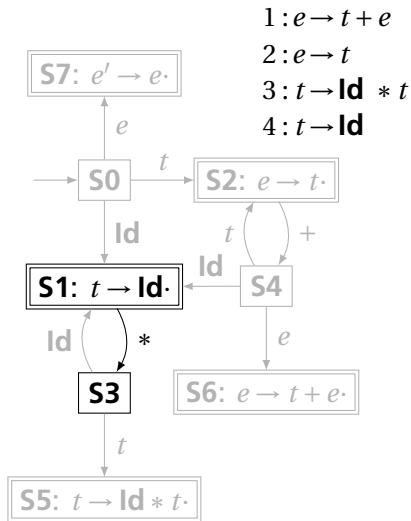

State	Action				Goto	
	Id	+	*	\$	e	t
0	s1				7	2
1		r4	s3	r4		

From S1, shift a $*$ and go to S3; or, if the next input could follow a t , reduce by rule 4. According to rule 1, $+$ could follow t ; from rule 2, $\$$ could.

Converting the LR(0) Automaton to an SLR Parsing Table

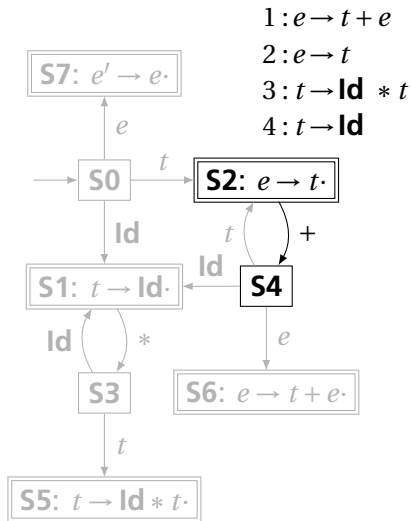

State	Action				Goto	
	Id	+	*	\$	e	t
0	s1				7	2
1		r4	s3	r4		
2		s4		r2		

From S2, shift a + and go to S4; or, if the next input could follow an e (only the end-of-input \$), reduce by rule 2.

Converting the LR(0) Automaton to an SLR Parsing Table

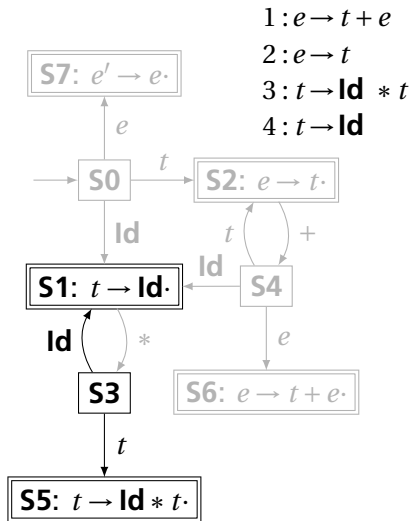

State	Action				Goto	
	Id	+	*	\$	e	t
0	s1				7	2
1		r4	s3	r4		
2		s4		r2		
3	s1					5

From S3, shift an **Id** and go to S1;
or cross a **t** and go to S5.

Converting the LR(0) Automaton to an SLR Parsing Table

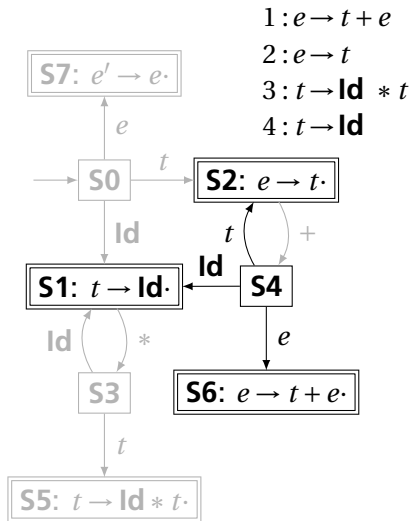

State	Action				Goto	
	Id	+	*	\$	e	t
0	s1				7	2
1		r4	s3	r4		
2		s4		r2		
3	s1					5
4	s1				6	2

From **S4**, shift an **Id** and go to **S1**;
 or cross an e or a t .

Converting the LR(0) Automaton to an SLR Parsing Table

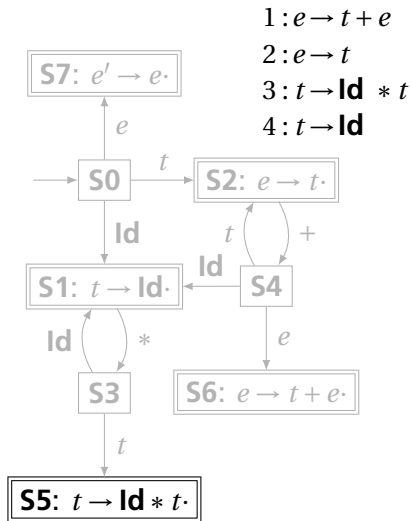

State	Action				Goto	
	Id	+	*	\$	e	t
0	s1				7	2
1		r4	s3	r4		
2		s4		r2		
3	s1					5
4	s1				6	2
5		r3		r3		

From S5, reduce using rule 3 if the next symbol could follow a t (again, $+$ and $\$$).

Converting the LR(0) Automaton to an SLR Parsing Table

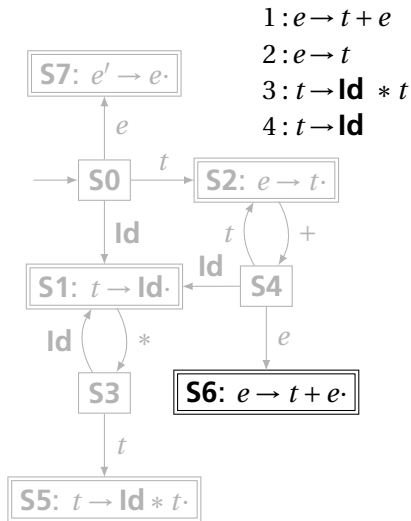

State	Action				Goto	
	Id	+	*	\$	e	t
0	s1				7	2
1		r4	s3	r4		
2		s4		r2		
3	s1					5
4	s1				6	2
5		r3		r3		
6				r1		

From S6, reduce using rule 1 if the next symbol could follow an e (\$ only).

Converting the LR(0) Automaton to an SLR Parsing Table

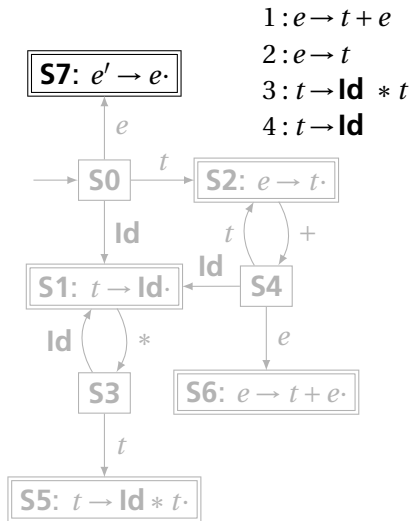

State	Action				Goto	
	Id	+	*	\$	e	t
0	s1				7	2
1		r4	s3	r4		
2		s4		r2		
3	s1					5
4	s1				6	2
5		r3		r3		
6				r1		
7				✓		

If, in S7, we just crossed an e , accept if we are at the end of the input.

Shift/Reduce Parsing with an SLR Table

1: $e \rightarrow t + e$

2: $e \rightarrow t$

3: $t \rightarrow \mathbf{Id} * t$

4: $t \rightarrow \mathbf{Id}$

State	Action				Goto	
	Id	+	*	\$	e	t
0	s1				7	2
1		r4	s3	r4		
2		s4		r2		
3	s1					5
4	s1				6	2
5		r3		r3		
6				r1		
7				✓		

Stack	Input	Action
0	Id * Id + Id \$	Shift, goto 1

Look at the state on top of the stack and the next input token.

Find the action (shift, reduce, or error) in the table.

In this case, shift the token onto the stack and mark it with state 1.

Shift/Reduce Parsing with an SLR Table

1: $e \rightarrow t + e$

2: $e \rightarrow t$

3: $t \rightarrow \mathbf{Id} * t$

4: $t \rightarrow \mathbf{Id}$

Stack	Input	Action
0	Id * Id + Id \$	Shift, goto 1
0 Id 1	* Id + Id \$	Shift, goto 3

Here, the state is 1, the next symbol is *, so shift and mark it with state 3.

State	Action				Goto	
	Id	+	*	\$	e	t
0	s1				7	2
1		r4	s3	r4		
2		s4		r2		
3	s1					5
4	s1				6	2
5		r3		r3		
6				r1		
7				✓		

Shift/Reduce Parsing with an SLR Table

1: $e \rightarrow t + e$

2: $e \rightarrow t$

3: $t \rightarrow \text{Id} * t$

4: $t \rightarrow \text{Id}$

State	Action				Goto	
	Id	+	*	\$	e	t
0	s1				7	2
1		r4	s3	r4		
2		s4		r2		
3	s1					5
4	s1				6	2
5		r3		r3		
6				r1		
7				✓		

Stack	Input	Action
0	Id * Id + Id \$	Shift, goto 1
0 Id	* Id + Id \$	Shift, goto 3
0 Id *	Id + Id \$	Shift, goto 1
0 Id * Id	+ Id \$	Reduce 4

Here, the state is 1, the next symbol is +. The table says reduce using rule 4.

Shift/Reduce Parsing with an SLR Table

1: $e \rightarrow t + e$

2: $e \rightarrow t$

3: $t \rightarrow \mathbf{Id} * t$

4: $t \rightarrow \mathbf{Id}$

State	Action				Goto	
	Id	+	*	\$	e	t
0	s1				7	2
1		r4	s3	r4		
2		s4		r2		
3	s1					5
4	s1				6	2
5		r3		r3		
6				r1		
7				✓		

Stack	Input	Action
		0
	Id * Id + Id \$	Shift, goto 1
		0 Id 1
	* Id + Id \$	Shift, goto 3
		0 Id * 1 3
	Id + Id \$	Shift, goto 1
0 Id 1 * 1 Id 1	+ Id \$	Reduce 4
0 Id 1 * 1	+ Id \$	

Remove the RHS of the rule (here, just **Id**), observe the state on the top of the stack, and consult the "goto" portion of the table.

Shift/Reduce Parsing with an SLR Table

- 1: $e \rightarrow t + e$
- 2: $e \rightarrow t$
- 3: $t \rightarrow \text{Id} * t$
- 4: $t \rightarrow \text{Id}$

State	Action				Goto	
	Id	+	*	\$	<i>e</i>	<i>t</i>
0	s1				7	2
1		r4	s3	r4		
2		s4		r2		
3	s1					5
4	s1				6	2
5		r3		r3		
6				r1		
7				✓		

Stack	Input	Action
0	Id * Id + Id \$	Shift, goto 1
0 Id	* Id + Id \$	Shift, goto 3
0 Id *	Id + Id \$	Shift, goto 1
0 Id * Id	+ Id \$	Reduce 4
0 Id * Id	+ Id \$	Reduce 3

Here, we push a *t* with state 5. This effectively “backs up” the LR(0) automaton and runs it over the newly added nonterminal.

In state 5 with an upcoming +, the action is “reduce 3.”

Shift/Reduce Parsing with an SLR Table

1: $e \rightarrow t + e$

2: $e \rightarrow t$

3: $t \rightarrow \mathbf{Id} * t$

4: $t \rightarrow \mathbf{Id}$

State	Action				Goto	
	Id	+	*	\$	<i>e</i>	<i>t</i>
0	s1				7	2
1		r4	s3	r4		
2		s4		r2		
3	s1					5
4	s1				6	2
5		r3		r3		
6				r1		
7				✓		

Stack	Input	Action
0	Id * Id + Id \$	Shift, goto 1
0 Id	* Id + Id \$	Shift, goto 3
0 Id *	Id + Id \$	Shift, goto 1
0 Id * Id	+ Id \$	Reduce 4
0 Id * Id	+ Id \$	Reduce 3
0 t	+ Id \$	Shift, goto 4

This time, we strip off the RHS for rule 3, $\mathbf{Id} * t$, exposing state 0, so we push a t with state 2.

Shift/Reduce Parsing with an SLR Table

1: $e \rightarrow t + e$

2: $e \rightarrow t$

3: $t \rightarrow \mathbf{Id} * t$

4: $t \rightarrow \mathbf{Id}$

State	Action				Goto	
	Id	+	*	\$	e	t
0	s1				7	2
1		r4	s3	r4		
2		s4		r2		
3	s1					5
4	s1				6	2
5		r3		r3		
6				r1		
7				✓		

Stack	Input	Action
0	Id * Id + Id \$	Shift, goto 1
0 Id	* Id + Id \$	Shift, goto 3
0 Id *	Id + Id \$	Shift, goto 1
0 Id * Id	+ Id \$	Reduce 4
0 Id * Id	+ Id \$	Reduce 3
0 t	+ Id \$	Shift, goto 4
0 t +	Id \$	Shift, goto 1
0 t + Id	\$	Reduce 4
0 t + t	\$	Reduce 2
0 t + e	\$	Reduce 1
0 e	\$	Accept

Types

A restriction on the possible interpretations of a segment of memory or other program construct.

Two uses:



Safety: avoids data being treated as something it isn't



Optimization: eliminates certain runtime decisions

Types of Types

Type	Examples
Basic	Machine words, floating-point numbers, addresses/pointers
Aggregate	Arrays, structs, classes
Function	Function pointers, lambdas

Basic Types

Groups of data the processor is designed to operate on.

On an ARM processor,

Type	Width (bits)
Unsigned/two's-complement binary	
Byte	8
Halfword	16
Word	32
IEEE 754 Floating Point	
Single-Precision scalars & vectors	32, 64, .., 256
Double-Precision scalars & vectors	64, 128, 192, 256

Derived types

Array: a list of objects of the same type, often fixed-length

Record: a collection of named fields, often of different types

Pointer/References: a reference to another object

Function: a reference to a block of code

C's Declarations and Declarators

Declaration: list of specifiers followed by a comma-separated list of declarators.

basic type
`static unsigned int (*f[10])(int, char*);`
specifiers declarator

Declarator's notation matches that of an expression: use it to return the basic type.

Largely regarded as the worst syntactic aspect of C: both pre- (pointers) and post-fix operators (arrays, functions).

Structs

Structs are the precursors of objects:

Group and restrict what can be stored in an object, but not what operations they permit.

Can fake object-oriented programming:

```
struct poly { ... };  
  
struct poly *poly_create();  
void      poly_destroy(struct poly *p);  
void      poly_draw(struct poly *p);  
void      poly_move(struct poly *p, int x, int y);  
int      poly_area(struct poly *p);
```

Unions: Variant Records

A struct holds all of its fields at once. A union holds only one of its fields at any time (the last written).

```
union token {
    int i;
    float f;
    char *string;
};

union token t;
t.i = 10;
t.f = 3.14159;      /* overwrite t.i */
char *s = t.string; /* return gibberish */
```

Applications of Variant Records

A primitive form of polymorphism:

```
struct poly {  
    int x, y;  
    int type;  
    union { int radius;  
           int size;  
           float angle; } d;  
};
```

If `poly.type == CIRCLE`, use `poly.d.radius`.

If `poly.type == SQUARE`, use `poly.d.size`.

If `poly.type == LINE`, use `poly.d.angle`.

Name vs. Structural Equivalence

```
struct f {  
    int x, y;  
} foo = { 0, 1 };  
  
struct b {  
    int x, y;  
} bar;  
  
bar = foo;
```

Is this legal in C? Should it be?

Type Expressions

C's declarators are unusual: they always specify a name along with its type.

Languages more often have *type expressions*: a grammar for expressing a type.

Type expressions appear in three places in C:

```
(int *) a           /* Type casts */  
sizeof(float [10]) /* Argument of sizeof() */  
int f(int, char *, int (*)(int)) /* Function argument types */
```

Static Semantic Analysis

Lexical analysis: Make sure tokens are valid

```
if i 3 "This"           /* valid Java tokens */  
#a1123                 /* not a token */
```

Syntactic analysis: Makes sure tokens appear in correct order

```
for ( i = 1 ; i < 5 ; i++ ) 3 + "foo"; /* valid Java syntax */  
for break                          /* invalid syntax */
```

Semantic analysis: Makes sure program is consistent

```
int v = 42 + 13;          /* valid in Java (if v is new) */  
return f + f(3);        /* invalid */
```

What To Check

Examples from Java:

Verify names are defined and are of the right type.

```
int i = 5;  
int a = z;      /* Error: cannot find symbol */  
int b = i[3];  /* Error: array required, but int found */
```

Verify the type of each expression is consistent.

```
int j = i + 53;  
int k = 3 + "hello"; /* Error: incompatible types */  
int l = k(42);      /* Error: k is not a method */  
if ("Hello") return 5; /* Error: incompatible types */  
String s = "Hello";  
int m = s;          /* Error: incompatible types */
```

How To Check: Depth-first AST Walk

Checking function: environment \rightarrow node \rightarrow type

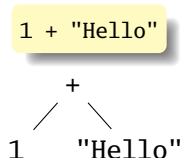
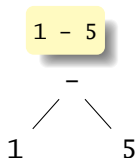

check(-)

check(1) = int

check(5) = int

Success: int - int = int

check(+)

check(1) = int

check("Hello") = string

FAIL: Can't add int and string

Ask yourself: at each kind of node, what must be true about the nodes below it? What is the type of the node?

How To Check: Symbols

Checking function: environment \rightarrow node \rightarrow type

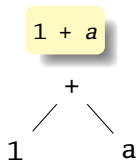

check(+)

check(1) = int

check(a) = int

Success: int + int = int

The key operation: determining the type of a symbol when it is encountered.

The environment provides a "symbol table" that holds information about each in-scope symbol.

Basic Static Scope in C, C++, Java, etc.

A name begins life where it is declared and ends at the end of its block.

From the CLRM, “The scope of an identifier declared at the head of a block begins at the end of its declarator, and persists to the end of the block.”

```
void foo()  
{  
    int x;  
  
}  
}
```

Hiding a Definition

Nested scopes can hide earlier definitions, giving a hole.

From the CLRM, "If an identifier is explicitly declared at the head of a block, including the block constituting a function, any declaration of the identifier outside the block is suspended until the end of the block."

```
void foo()
{
    int x;
    while ( a < 10 ) {
        int x;
    }
}
```

Static Scoping in Java

```
public void example() {  
    // x, y, z not visible  
  
    int x;  
    // x visible  
  
    for ( int y = 1 ; y < 10 ; y++ ) {  
        // x, y visible  
  
        int z;  
        // x, y, z visible  
    }  
  
    // x visible  
}
```

Basic Static Scope in O'Caml

A name is bound after the "in" clause of a "let." If the name is re-bound, the binding takes effect *after* the "in."

```
let x = 8 in  
  
let x = x + 1 in
```

Returns the pair (12, 8):

```
let x = 8 in  
(let x = x + 2 in  
  x + 2),  
x
```

Let Rec in O'Caml

The “rec” keyword makes a name visible to its definition. This only makes sense for functions.

```
let rec fib i =  
  if i < 1 then 1 else  
    fib (i-1) + fib (i-2)  
in  
  fib 5
```

```
(* Nonsensical *)  
let rec x = x + 3 in
```

Let...and in O'Caml

Let...and lets you bind multiple names at once. Definitions are not mutually visible unless marked "rec."

```
let x = 8
and y = 9 in
```

```
let rec fac n =
  if n < 2 then
    1
  else
    n * fac1 n
and fac1 n = fac (n - 1)
in
fac 5
```

Nesting Function Definitions

```
let articles words =  
  let report w =  
    let count = List.length  
      (List.filter ((=) w) words)  
    in w ^ ": " ^  
      string_of_int count  
  in String.concat ", "  
    (List.map report ["a"; "the"])  
in articles  
  ["the"; "plt"; "class"; "is";  
   "a"; "pain"; "in";  
   "the"; "butt"]
```

```
let count words w = List.length  
  (List.filter ((=) w) words) in  
let report words w = w ^ ": " ^  
  string_of_int (count words w) in  
let articles words =  
  String.concat ", "  
  (List.map (report words)  
   ["a"; "the"]) in  
articles  
  ["the"; "plt"; "class"; "is";  
   "a"; "pain"; "in";  
   "the"; "butt"]
```

Produces "a: 1, the: 2"

Applicative- and Normal-Order Evaluation

```
int p(int i) {  
    printf("%d ", i);  
    return i;  
}  
  
void q(int a, int b, int c)  
{  
    int total = a;  
    printf("%d ", b);  
    total += c;  
}  
  
q( p(1), 2, p(3) );
```

What does this print?

Applicative- vs. and Normal-Order

Most languages use applicative order.

Macro-like languages often use normal order.

```
#define p(x) (printf("%d ",x), x)

#define q(a,b,c) total = (a), \
    printf("%d ", (b)), \
    total += (c)

q( p(1), 2, p(3) );
```

Prints 1 2 3.

Some functional languages also use normal order evaluation to avoid doing work. "Lazy Evaluation"

Storage Classes and Memory Layout

Stack: objects created/destroyed in last-in, first-out order

Heap: objects created/destroyed in any order; automatic garbage collection optional

Static: objects allocated at compile time; persist throughout run

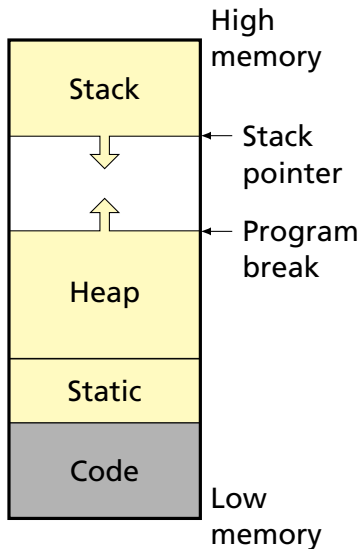

Static Objects

```
class Example {  
    public static final int a = 3;  
  
    public void hello() {  
        System.out.println("Hello");  
    }  
}
```

Advantages

Zero-cost memory management

Often faster access (address a constant)

No out-of-memory danger

Examples

Static class variable

Code for hello method

String constant "Hello"

Information about the Example class

Disadvantages

Size and number must be known beforehand

Wasteful if sharing is possible

Stack-Allocated Objects



Natural for supporting recursion.

Idea: some objects persist from when a procedure is called to when it returns.

Naturally implemented with a stack: linear array of memory that grows and shrinks at only one boundary.

Each invocation of a procedure gets its own *frame* (*activation record*) where it stores its own local variables and bookkeeping information.

An Activation Record: The State Before Calling *bar*

```
int foo(int a, int b) {  
    int c, d;  
    bar(1, 2, 3);  
}
```

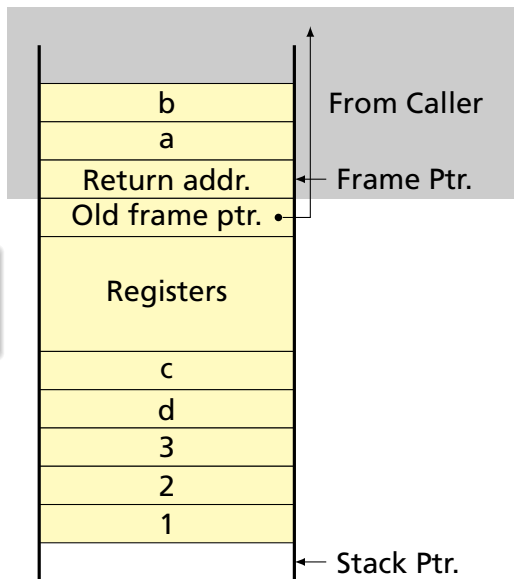

Recursive Fibonacci

(Real C)

```
int fib(int n) {  
    if (n<2)  
        return 1;  
    else  
        return  
            fib(n-1)  
            +  
            fib(n-2);  
}
```

(Assembly-like C)

```
int fib(int n) {  
    int tmp1, tmp2, tmp3;  
    tmp1 = n < 2;  
    if (!tmp1) goto L1;  
    return 1;  
L1: tmp1 = n - 1;  
    tmp2 = fib(tmp1);  
L2: tmp1 = n - 2;  
    tmp3 = fib(tmp1);  
L3: tmp1 = tmp2 + tmp3;  
    return tmp1;  
}
```

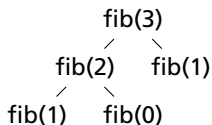

Executing fib(3)

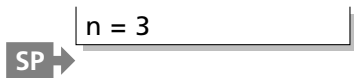

```
int fib(int n) {
    int tmp1, tmp2, tmp3;
    tmp1 = n < 2;
    if (!tmp1) goto L1;
    return 1;
L1: tmp1 = n - 1;
    tmp2 = fib(tmp1);
L2: tmp1 = n - 2;
    tmp3 = fib(tmp1);
L3: tmp1 = tmp2 + tmp3;
    return tmp1;
}
```

Executing fib(3)

```
int fib(int n) {  
    int tmp1, tmp2, tmp3;  
    tmp1 = n < 2;  
    if (!tmp1) goto L1;  
    return 1;  
L1: tmp1 = n - 1;  
    tmp2 = fib(tmp1);  
L2: tmp1 = n - 2;  
    tmp3 = fib(tmp1);  
L3: tmp1 = tmp2 + tmp3;  
    return tmp1;  
}
```

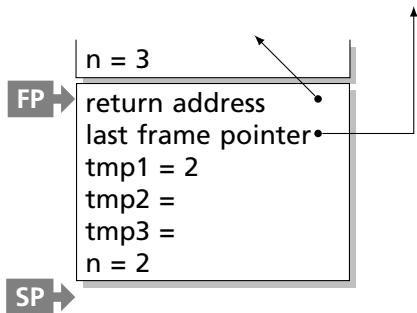

Executing fib(3)

```
int fib(int n) {  
    int tmp1, tmp2, tmp3;  
    tmp1 = n < 2;  
    if (!tmp1) goto L1;  
    return 1;  
L1: tmp1 = n - 1;  
    tmp2 = fib(tmp1);  
L2: tmp1 = n - 2;  
    tmp3 = fib(tmp1);  
L3: tmp1 = tmp2 + tmp3;  
    return tmp1;  
}
```

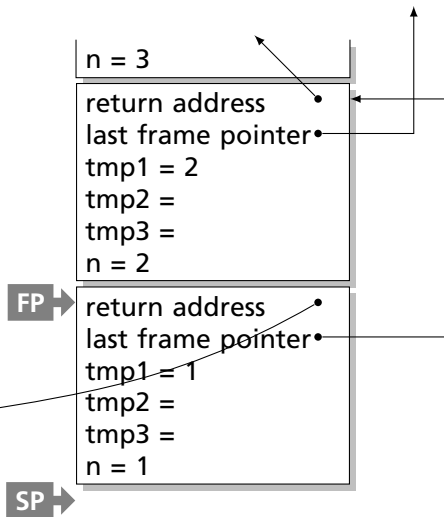

Executing fib(3)

```
int fib(int n) {  
    int tmp1, tmp2, tmp3;  
    tmp1 = n < 2;  
    if (!tmp1) goto L1;  
    return 1;  
L1: tmp1 = n - 1;  
    tmp2 = fib(tmp1);  
L2: tmp1 = n - 2;  
    tmp3 = fib(tmp1);  
L3: tmp1 = tmp2 + tmp3;  
    return tmp1;  
}
```

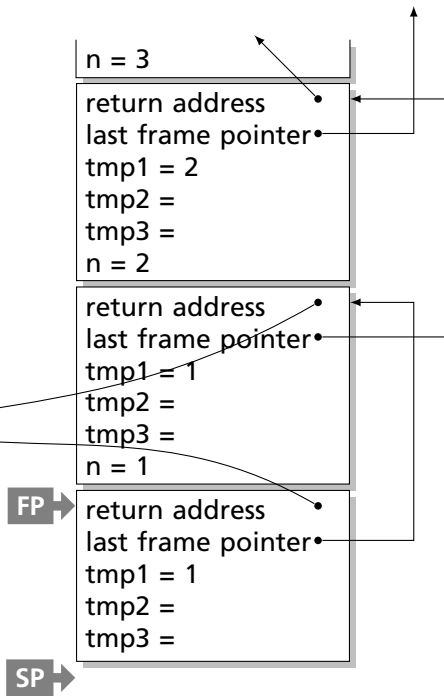

Executing fib(3)

```
int fib(int n) {  
    int tmp1, tmp2, tmp3;  
    tmp1 = n < 2;  
    if (!tmp1) goto L1;  
    return 1;  
L1: tmp1 = n - 1;  
    tmp2 = fib(tmp1);  
L2: tmp1 = n - 2;  
    tmp3 = fib(tmp1);  
L3: tmp1 = tmp2 + tmp3;  
    return tmp1;  
}
```

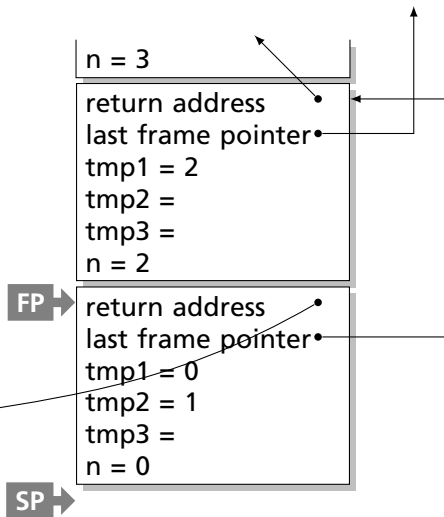

Executing fib(3)

```
int fib(int n) {  
    int tmp1, tmp2, tmp3;  
    tmp1 = n < 2;  
    if (!tmp1) goto L1;  
    return 1;  
L1: tmp1 = n - 1;  
    tmp2 = fib(tmp1);  
L2: tmp1 = n - 2;  
    tmp3 = fib(tmp1);  
L3: tmp1 = tmp2 + tmp3;  
    return tmp1;  
}
```

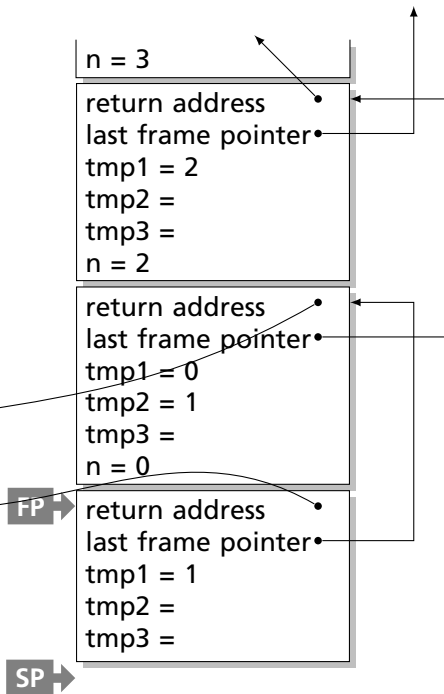

Executing fib(3)

```
int fib(int n) {  
    int tmp1, tmp2, tmp3;  
    tmp1 = n < 2;  
    if (!tmp1) goto L1;  
    return 1;  
L1: tmp1 = n - 1;  
    tmp2 = fib(tmp1);  
L2: tmp1 = n - 2;  
    tmp3 = fib(tmp1);  
L3: tmp1 = tmp2 + tmp3;  
    return tmp1;  
}
```

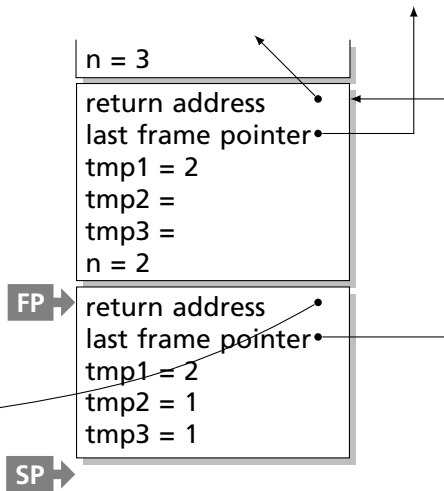

Executing fib(3)

```
int fib(int n) {  
    int tmp1, tmp2, tmp3;  
    tmp1 = n < 2;  
    if (!tmp1) goto L1;  
    return 1;  
L1: tmp1 = n - 1;  
    tmp2 = fib(tmp1);  
L2: tmp1 = n - 2;  
    tmp3 = fib(tmp1);  
L3: tmp1 = tmp2 + tmp3;  
    return tmp1;  
}
```

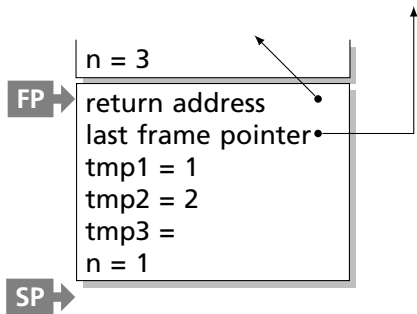

Executing fib(3)

```
int fib(int n) {  
    int tmp1, tmp2, tmp3;  
    tmp1 = n < 2;  
    if (!tmp1) goto L1;  
    return 1;  
L1: tmp1 = n - 1;  
    tmp2 = fib(tmp1);  
L2: tmp1 = n - 2;  
    tmp3 = fib(tmp1);  
L3: tmp1 = tmp2 + tmp3;  
    return tmp1;  
}
```

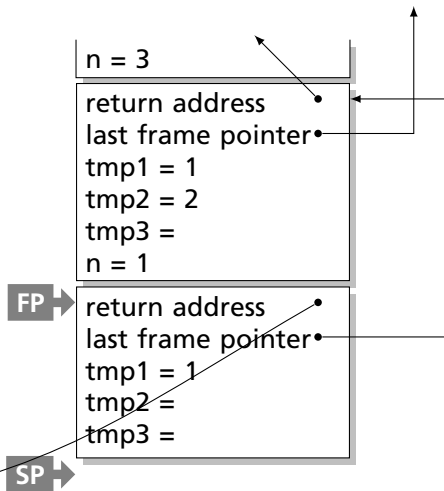

Executing fib(3)

```
int fib(int n) {  
    int tmp1, tmp2, tmp3;  
    tmp1 = n < 2;  
    if (!tmp1) goto L1;  
    return 1;  
L1: tmp1 = n - 1;  
    tmp2 = fib(tmp1);  
L2: tmp1 = n - 2;  
    tmp3 = fib(tmp1);  
L3: tmp1 = tmp2 + tmp3;  
    return tmp1;  
}
```

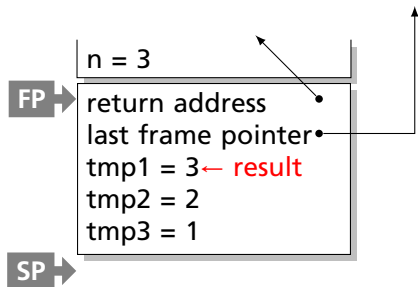

Allocating Fixed-Size Arrays

Local arrays with fixed size are easy to stack.

```
void foo()  
{  
  int a;  
  int b[10];  
  int c;  
}
```

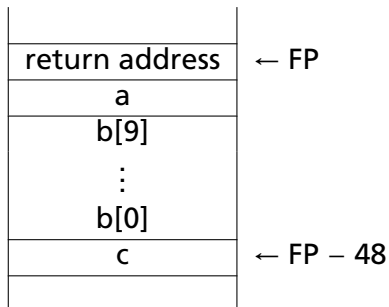

Allocating Variable-Sized Arrays

Variable-sized local arrays aren't as easy.

```
void foo(int n)
{
    int a;
    int b[n];
    int c;
}
```

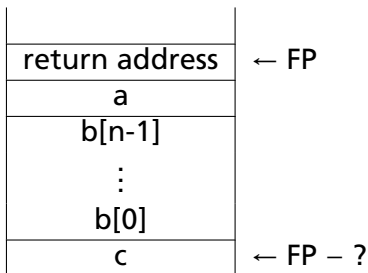

Doesn't work: generated code expects a fixed offset for c.
Even worse for multi-dimensional arrays.

Allocating Variable-Sized Arrays

As always:
add a level of indirection

```
void foo(int n)
{
    int a;
    int b[n];
    int c;
}
```

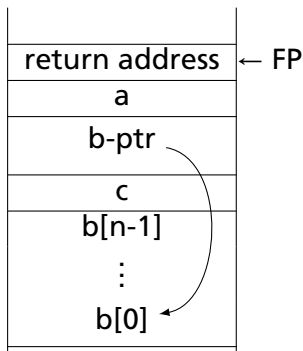

Variables remain constant offset from frame pointer.

Nesting Function Definitions

```
let articles words =  
  let report w =  
    let count = List.length  
      (List.filter ((=) w) words)  
    in w ^ ": " ^  
      string_of_int count  
  in String.concat ", "  
    (List.map report ["a"; "the"])  
in articles  
  ["the"; "plt"; "class"; "is";  
   "a"; "pain"; "in";  
   "the"; "butt"]
```

```
let count words w = List.length  
  (List.filter ((=) w) words) in  
let report words w = w ^ ": " ^  
  string_of_int (count words w) in  
let articles words =  
  String.concat ", "  
  (List.map (report words)  
   ["a"; "the"]) in  
articles  
  ["the"; "plt"; "class"; "is";  
   "a"; "pain"; "in";  
   "the"; "butt"]
```

Produces "a: 1, the: 2"

Implementing Nested Functions with Access Links

```
let a x s =  
  let b y =  
    let c z = z + s in  
    let d w = c (w+1) in  
    d (y+1) in (* b *)  
  let e q = b (q+1) in  
  e (x+1) (* a *)
```

a: (access link) •
x = 5
s = 42

What does "a 5 42" give?

Implementing Nested Functions with Access Links

```
let a x s =  
  let b y =  
    let c z = z + s in  
    let d w = c (w+1) in  
    d (y+1) in (* b *)  
  let e q = b (q+1) in  
e (x+1) (* a *)
```

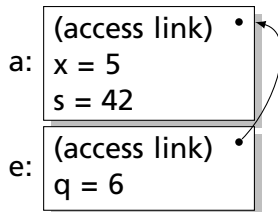

What does "a 5 42" give?

Implementing Nested Functions with Access Links

```
let a x s =  
  let b y =  
    let c z = z + s in  
    let d w = c (w+1) in  
    d (y+1) in (* b *)  
  let e q = b (q+1) in  
e (x+1) (* a *)
```

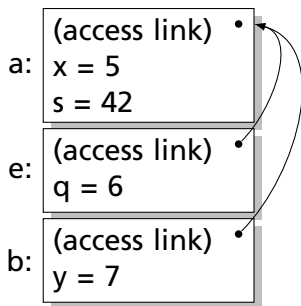

What does "a 5 42" give?

Implementing Nested Functions with Access Links

```
let a x s =  
  let b y =  
    let c z = z + s in  
    let d w = c (w+1) in  
    d (y+1) in (* b *)  
  let e q = b (q+1) in  
  e (x+1) (* a *)
```

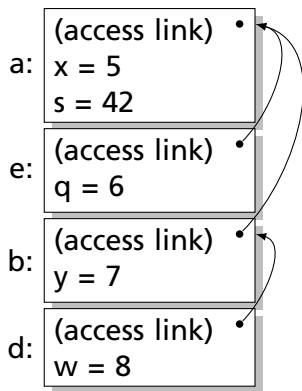

What does "a 5 42" give?

Implementing Nested Functions with Access Links

```
let a x s =  
  let b y =  
    let c z = z + s in  
    let d w = c (w+1) in  
    d (y+1) in (* b *)  
  let e q = b (q+1) in  
  e (x+1) (* a *)
```

What does "a 5 42" give?

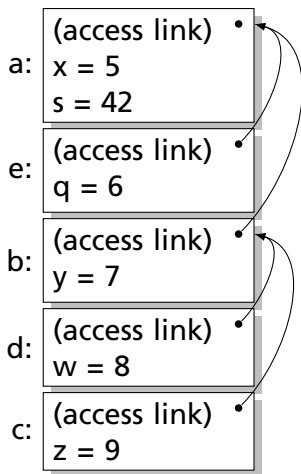

Layout of Records and Unions

Modern processors have byte-addressable memory.

0
1
2
3



The IBM 360 (c. 1964) helped to popularize byte-addressable memory.

Many data types (integers, addresses, floating-point numbers) are wider than a byte.

16-bit integer: 1 0

32-bit integer: 3 2 1 0



Layout of Records and Unions

Modern memory systems read data in 32-, 64-, or 128-bit chunks:

3	2	1	0
7	6	5	4
11	10	9	8

Reading an aligned 32-bit value is fast: a single operation.

3	2	1	0
7	6	5	4
11	10	9	8

It is harder to read an unaligned value: two reads plus shifting

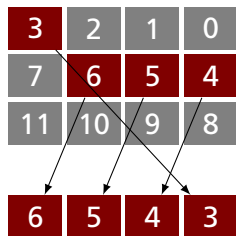

SPARC and ARM prohibit unaligned accesses

MIPS has special unaligned load/store instructions

x86, 68k run more slowly with unaligned accesses

Padding

To avoid unaligned accesses, the C compiler pads the layout of unions and records.

Rules:

- ▶ Each n -byte object must start on a multiple of n bytes (no unaligned accesses).
- ▶ Any object containing an n -byte object must be of size mn for some integer m (aligned even when arrayed).

```
struct padded {  
    int x;    /* 4 bytes */  
    char z;   /* 1 byte  */  
    short y;  /* 2 bytes */  
    char w;   /* 1 byte  */  
};
```

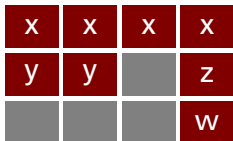

```
struct padded {  
    char a;   /* 1 byte  */  
    short b;  /* 2 bytes */  
    short c;  /* 2 bytes */  
};
```

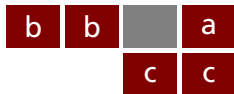

Unions

A C *struct* has a separate space for each field; a C *union* shares one space among all fields

```
union intchar {  
    int i;    /* 4 bytes */  
    char c;  /* 1 byte  */  
};
```



```
union twostructs {  
    struct {  
        char c;    /* 1 byte */  
        int i;     /* 4 bytes */  
    } a;  
    struct {  
        short s1; /* 2 bytes */  
        short s2; /* 2 bytes */  
    } b;  
};
```

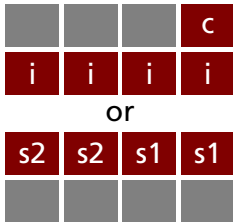

Arrays



Basic policy in C: an array is just one object after another in memory.

```
int a[10];
```

This is why you need padding at the end of *structs*.

```
struct {  
    int a;  
    char c;  
} b[2];
```

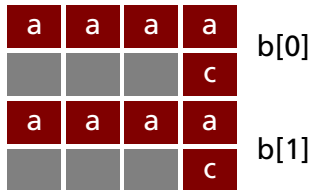
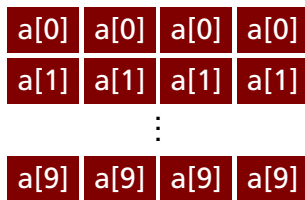

Arrays and Aggregate types

The largest primitive type
dictates the alignment

```
struct {  
  short a;  
  short b;  
  char c;  
} d[4];
```

b	b	a	a	d[0]
a	a		c	d[1]
	c	b	b	
b	b	a	a	d[2]
a	a		c	d[3]
	c	b	b	

Arrays of Arrays

```
char a[4];
```

a[3]	a[2]	a[1]	a[0]
------	------	------	------

```
char a[3][4];
```

a[0][3]	a[0][2]	a[0][1]	a[0][0]	a[0]
a[1][3]	a[1][2]	a[1][1]	a[1][0]	a[1]
a[2][3]	a[2][2]	a[2][1]	a[2][0]	a[2]

Heap-Allocated Storage

Static works when you know everything beforehand and always need it.

Stack enables, but also requires, recursive behavior.

A *heap* is a region of memory where blocks can be allocated and deallocated in any order.

(These heaps are different than those in, e.g., heapsort)

Dynamic Storage Allocation in C

```
struct point {
    int x, y;
};

int play_with_points(int n)
{
    int i;
    struct point *points;

    points = malloc(n * sizeof(struct point));

    for ( i = 0 ; i < n ; i++ ) {
        points[i].x = random();
        points[i].y = random();
    }

    /* do something with the array */

    free(points);
}
```

Dynamic Storage Allocation



Dynamic Storage Allocation



↓ free()

Dynamic Storage Allocation



↓ free()



Dynamic Storage Allocation



↓ free()



↓ malloc()

Dynamic Storage Allocation



↓ free()



↓ malloc()



Dynamic Storage Allocation

Rules:

Each allocated block contiguous (no holes)

Blocks stay fixed once allocated

malloc()

Find an area large enough for requested block

Mark memory as allocated

free()

Mark the block as unallocated



Simple Dynamic Storage Allocation

Maintaining information about free memory

Simplest: Linked list

The algorithm for locating a suitable block

Simplest: First-fit

The algorithm for freeing an allocated block

Simplest: Coalesce adjacent free blocks

Simple Dynamic Storage Allocation

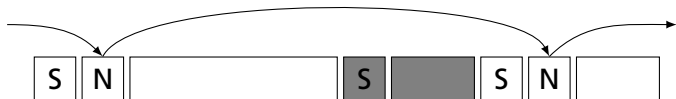

Simple Dynamic Storage Allocation

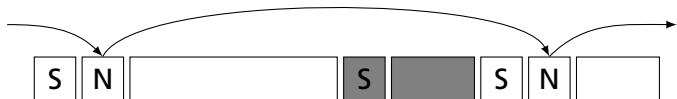

`malloc([shaded box])`

Simple Dynamic Storage Allocation

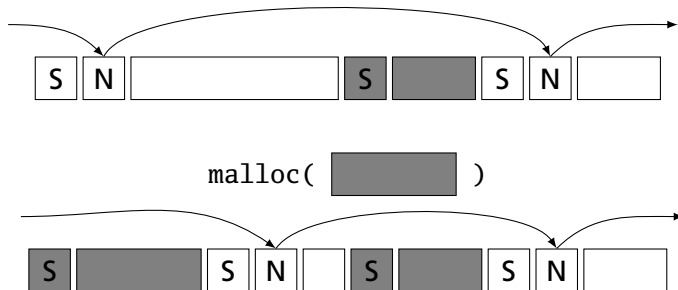

Simple Dynamic Storage Allocation

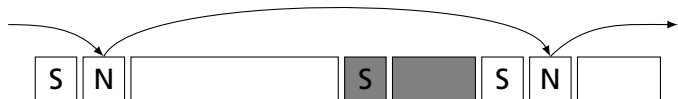

`malloc([gray box])`

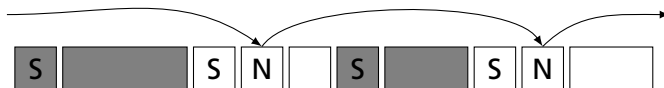

`free(•)`

Simple Dynamic Storage Allocation

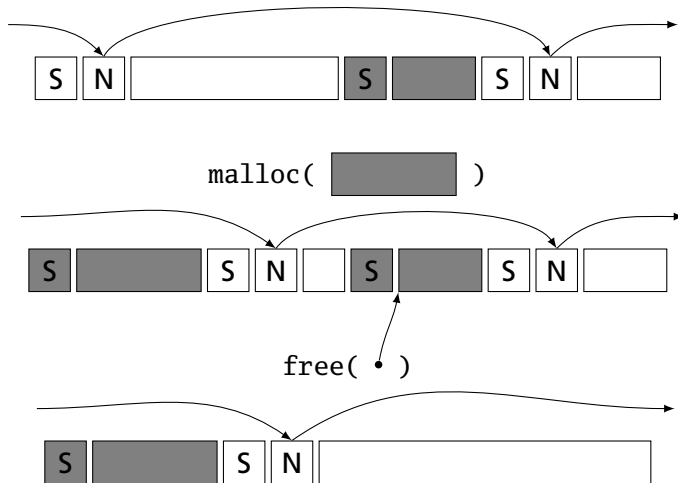

Fragmentation

malloc() seven times give



free() four times gives



malloc() ?

Need more memory; can't use fragmented memory.

Hockey smile



Fragmentation and Handles

Standard CS solution: Add another layer of indirection.

Always reference memory through "handles."

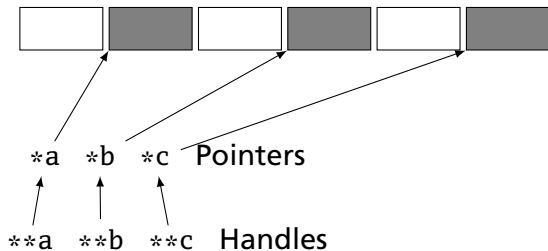

The original Macintosh did this to save memory.

Fragmentation and Handles

Standard CS solution: Add another layer of indirection.

Always reference memory through "handles."

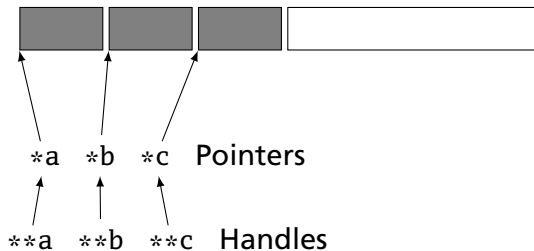

The original Macintosh did this to save memory.

Automatic Garbage Collection

Entrust the runtime system with freeing heap objects

Now common: Java, C#, Javascript, Python, Ruby, OCaml and most functional languages

Advantages

Much easier for the programmer

Greatly improves reliability: no memory leaks, double-freeing, or other memory management errors

Disadvantages

Slower, sometimes unpredictably so

May consume more memory



Reference Counting

What and when to free?

- ▶ Maintain count of references to each object
- ▶ Free when count reaches zero

```
let a = (42, 17) in  
let b = [a;a] in  
let c = (1,2)::b in  
b
```

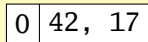

A diagram showing a memory cell with a yellow background. The cell is a rectangle divided into two parts. The left part contains the number '0', and the right part contains the text '42, 17'.

0	42, 17
---	--------

Reference Counting

What and when to free?

- ▶ Maintain count of references to each object
- ▶ Free when count reaches zero

```
let a = (42, 17) in  
let b = [a;a] in  
let c = (1,2)::b in  
b
```

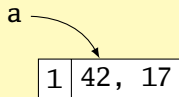

Reference Counting

What and when to free?

- ▶ Maintain count of references to each object
- ▶ Free when count reaches zero

```
let a = (42, 17) in  
let b = [a;a] in  
let c = (1,2)::b in  
b
```

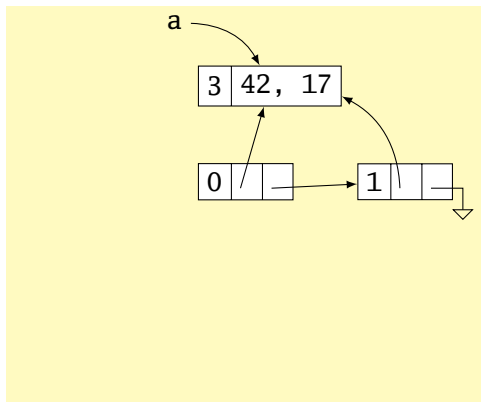

Reference Counting

What and when to free?

- ▶ Maintain count of references to each object
- ▶ Free when count reaches zero

```
let a = (42, 17) in  
let b = [a;a] in  
let c = (1,2)::b in  
b
```

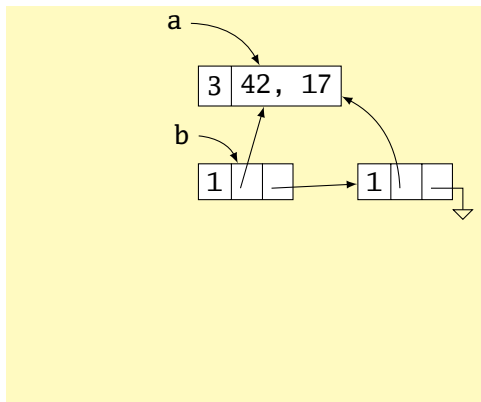

Reference Counting

What and when to free?

- ▶ Maintain count of references to each object
- ▶ Free when count reaches zero

```
let a = (42, 17) in  
let b = [a;a] in  
let c = (1,2)::b in  
b
```

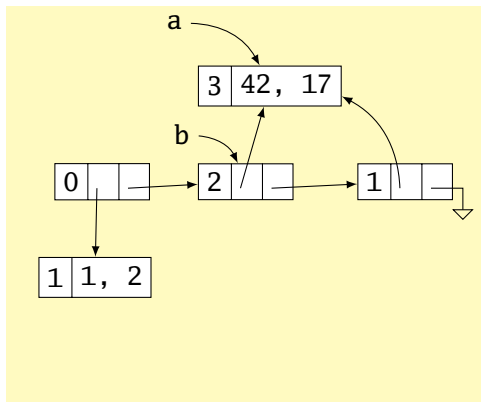

Reference Counting

What and when to free?

- ▶ Maintain count of references to each object
- ▶ Free when count reaches zero

```
let a = (42, 17) in  
let b = [a;a] in  
let c = (1,2)::b in  
b
```

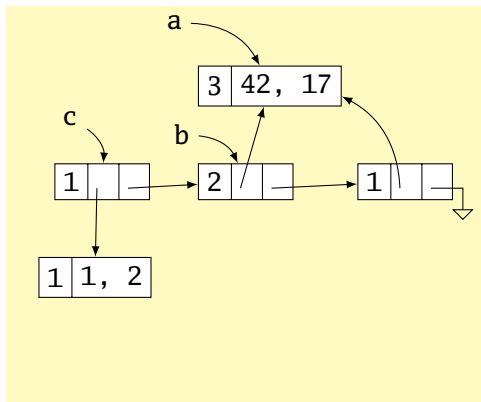

Reference Counting

What and when to free?

- ▶ Maintain count of references to each object
- ▶ Free when count reaches zero

```
let a = (42, 17) in
let b = [a;a] in
let c = (1,2)::b in
b
```

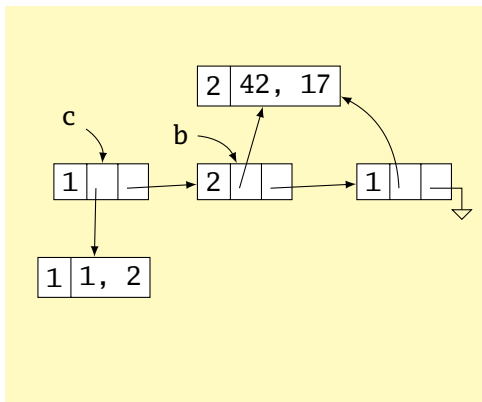

Reference Counting

What and when to free?

- ▶ Maintain count of references to each object
- ▶ Free when count reaches zero

```
let a = (42, 17) in  
let b = [a;a] in  
let c = (1,2)::b in  
b
```

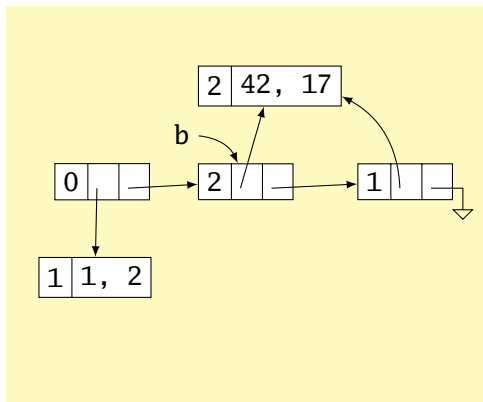

Reference Counting

What and when to free?

- ▶ Maintain count of references to each object
- ▶ Free when count reaches zero

```
let a = (42, 17) in  
let b = [a;a] in  
let c = (1,2)::b in  
b
```

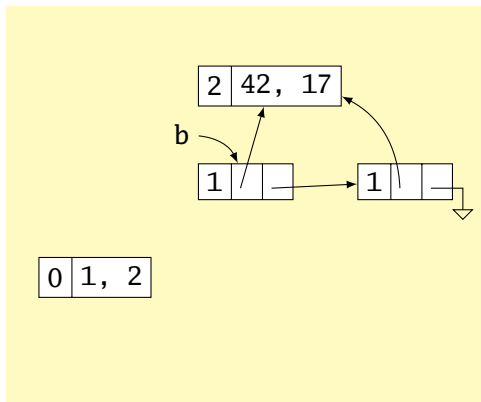

Reference Counting

What and when to free?

- ▶ Maintain count of references to each object
- ▶ Free when count reaches zero

```
let a = (42, 17) in  
let b = [a;a] in  
let c = (1,2)::b in  
b
```

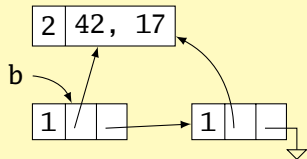

Issues with Reference Counting

Circular structures defy reference counting:



Neither is reachable, yet both have non-zero reference counts.

High overhead (must update counts constantly), although incremental

Mark-and-Sweep

What and when to free?

- ▶ Stop-the-world algorithm invoked when memory full
- ▶ Breadth-first-search marks all reachable memory
- ▶ All unmarked items freed

```
let a = (42, 17) in  
let b = [a;a] in  
let c = (1,2)::b in  
b
```

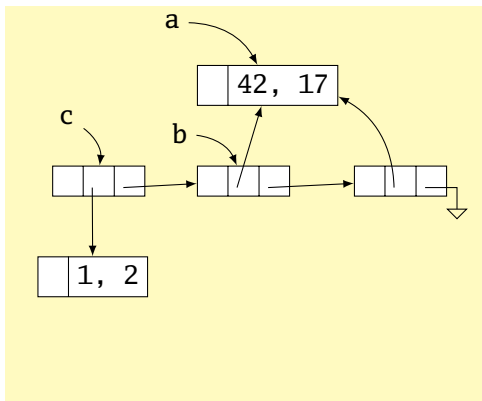

Mark-and-Sweep

What and when to free?

- ▶ Stop-the-world algorithm invoked when memory full
- ▶ Breadth-first-search marks all reachable memory
- ▶ All unmarked items freed

```
let a = (42, 17) in  
let b = [a;a] in  
let c = (1,2)::b in  
b
```

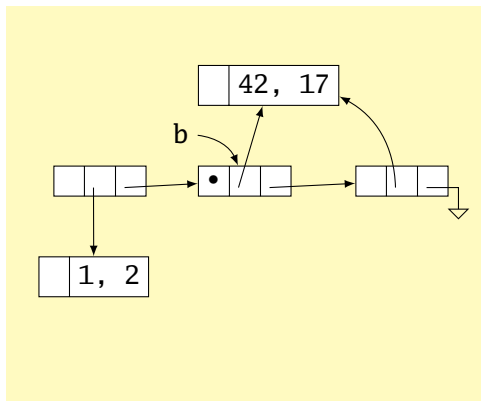

Mark-and-Sweep

What and when to free?

- ▶ Stop-the-world algorithm invoked when memory full
- ▶ Breadth-first-search marks all reachable memory
- ▶ All unmarked items freed

```
let a = (42, 17) in  
let b = [a;a] in  
let c = (1,2)::b in  
b
```

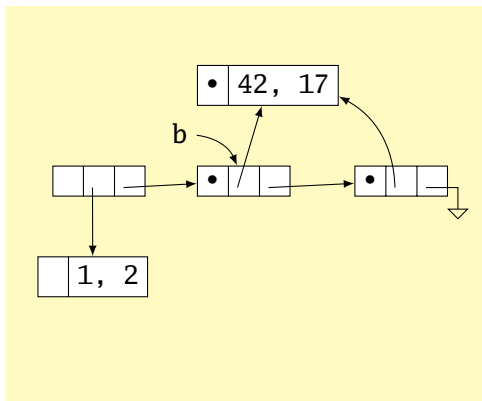

Mark-and-Sweep

What and when to free?

- ▶ Stop-the-world algorithm invoked when memory full
- ▶ Breadth-first-search marks all reachable memory
- ▶ All unmarked items freed

```
let a = (42, 17) in  
let b = [a;a] in  
let c = (1,2)::b in  
b
```

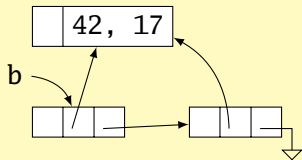

Mark-and-Sweep

Mark-and-sweep is faster overall; may induce big pauses

Mark-and-compact variant also moves or copies reachable objects to eliminate fragmentation

Incremental garbage collectors try to avoid doing everything at once

Most objects die young; generational garbage collectors segregate heap objects by age

Parallel garbage collection tricky

Real-time garbage collection tricky

Single Inheritance

Simple: Add new fields to end of the object

Fields in base class always at same offset in derived class
(compiler never reorders)

Consequence: Derived classes can never remove fields

C++

```
class Shape {  
    double x, y;  
};  
  
class Box : Shape {  
    double h, w;  
};  
  
class Circle : Shape {  
    double r;  
};
```

Equivalent C

```
struct Shape {  
    double x, y;  
};  
  
struct Box {  
    double x, y;  
    double h, w;  
};  
  
struct Circle {  
    double x, y;  
    double r;  
};
```

Virtual Functions

```
class Shape {  
    virtual void draw(); // Invoked by object's run-time class  
}; // not its compile-time type.  
  
class Line : public Shape {  
    void draw();  
}  
  
class Arc : public Shape {  
    void draw();  
};  
  
Shape *s[10];  
s[0] = new Line;  
s[1] = new Arc;  
s[0]->draw(); // Invoke Line::draw()  
s[1]->draw(); // Invoke Arc::draw()
```

Virtual Functions

Trick: add to each object a pointer to the virtual table for its type, filled with pointers to the virtual functions.

Like the objects themselves, the virtual table for each derived type begins identically.

```
struct A {  
    int x;  
    virtual void Foo();  
    virtual void Bar();  
};  
  
struct B : A {  
    int y;  
    virtual void Foo();  
    virtual void Baz();  
};  
  
A a1;  
A a2;  
B b1;
```

A's Vtbl

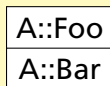

a1



a2



B's Vtbl

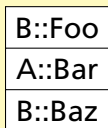

b1

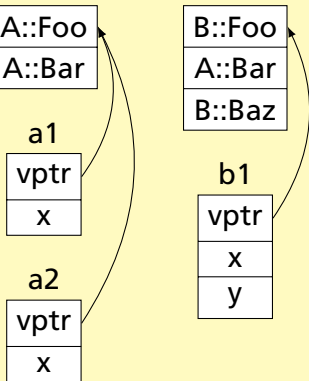
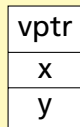

C++'s Exceptions

```
struct Except {} ex; // This struct functions as an exception

void top(void) {
    try {
        child();
    } catch (Except e) { // throw sends control here
        printf("oops\n");
    }
}

void child() {
    child2();
}

void child2() {
    throw ex; // Pass control up to the catch block
}
```

The diagram illustrates the flow of control during an exception. A red arrow labeled '1' points from the end of the `try` block in `top()` to the start of the `child()` function. A red arrow labeled '2' points from the end of the `child2()` function to the `throw` statement. A blue arrow labeled '3' points from the `throw` statement back to the `catch` block in `top()`, showing that control is transferred to the catch block when an exception is thrown.

C's setjmp/longjmp: Idiosyncratic Exceptions

```
#include <setjmp.h>

jmp_buf closure;          /* return address, stack & frame ptrs. */

void top(void) {
    switch ( setjmp(closure) ) { /* normal: store closure, return 0 */
                                /* longjmp jumps here, returns 1 */
    case 0: child();           /* unexceptional case */
            break;
    case 1: break;           /* longjmp( ,1) called */
    }
}

void child() {
    child2();
}

void child2() {
    longjmp(closure, 1);
}
```

The diagram illustrates the control flow of the provided C code. Red arrows represent the normal execution path, while blue arrows represent the path taken by `longjmp`.

- 1**: The `setjmp(closure)` call in `top()` returns 0, indicating a normal return.
- 2**: Execution proceeds to the `case 0` block in `top()`, where `child()` is called.
- 3**: Execution proceeds to `child()`, which calls `child2()`.
- 4**: Execution proceeds to `child2()`, which calls `longjmp(closure, 1)`.
- 5**: The `longjmp` call jumps back to the `setjmp(closure)` call in `top()`, where it returns 1.

Implementing Exceptions

One way: maintain a stack of exception handlers

```
try {  
    child();  
} catch (Ex e) {  
    foo();  
}
```

```
void child() {  
    child2();  
}
```

```
void child2() {  
    throw ex;  
}
```

```
    push(Ex, Handler); // Push handler on stack  
    child();  
    pop(); // Normal termination  
    goto Exit; // Jump over "catch"  
Handler:  
    foo(); // Body of "catch"  
Exit:
```

```
void child() {  
    child2();  
}
```

```
void child2() {  
    throw(ex); // Unroll stack; find handler  
}
```

Incurs overhead, even when no exceptions thrown

Implementing Exceptions with Tables

Q: When an exception is *thrown*, where was the last *try*?

A: Consult a table: relevant handler or “pop” for every PC

1	<code>void foo() {</code>		
2			
3	<code>try {</code>		
4	<code>bar();</code>	5: query	
5	<code>} catch (Ex1 e) {</code>		1-2 Pop stack
6	<code>a();</code>	6: handle	3-5 Handler @ 5 for Ex1
7	<code>}</code>		
8	<code>}</code>		
9			
10	<code>void bar() {</code>		
11	<code>baz();</code>	4: pop stack	
12	<code>}</code>	3: query	6-15 Pop stack
13			
14	<code>void baz() {</code>		
15		2: pop stack	
16	<code>try {</code>		
17	<code>throw ex1;</code>	1: query	16-18 Handler @ 14 for Ex2
18	<code>} catch (Ex2 e) {</code>		
19	<code>b();</code>		
20	<code>}</code>		19-21 Pop stack
21	<code>}</code>		

Stack-Based IR: Java Bytecode

```
int gcd(int a, int b) {  
    while (a != b) {  
        if (a > b)  
            a -= b;  
        else  
            b -= a;  
    }  
    return a;  
}
```

```
# javap -c Gcd  
  
Method int gcd(int, int)  
  0 goto 19  
  
  3 iload_1      // Push a  
  4 iload_2      // Push b  
  5 if_icmple 15 // if a <= b goto 15  
  
  8 iload_1      // Push a  
  9 iload_2      // Push b  
10 isub         // a - b  
11 istore_1     // Store new a  
12 goto 19  
  
15 iload_2      // Push b  
16 iload_1      // Push a  
17 isub         // b - a  
18 istore_2     // Store new b  
  
19 iload_1      // Push a  
20 iload_2      // Push b  
21 if_icmpne 3  // if a != b goto 3  
  
24 iload_1      // Push a  
25 ireturn     // Return a
```



Stack-Based IRs

Advantages:

- ▶ Trivial translation of expressions
- ▶ Trivial interpreters
- ▶ No problems with exhausting registers
- ▶ Often compact



Disadvantages:

- ▶ Semantic gap between stack operations and modern register machines
- ▶ Hard to see what communicates with what
- ▶ Difficult representation for optimization

Register-Based IR: Mach SUIF

```
int gcd(int a, int b) {  
    while (a != b) {  
        if (a > b)  
            a -= b;  
        else  
            b -= a;  
    }  
    return a;  
}
```



```
gcd:  
gcd._gcdTmp0:  
    sne    $vr1.s32 <- gcd.a,gcd.b  
    seq    $vr0.s32 <- $vr1.s32,0  
    btrue  $vr0.s32,gcd._gcdTmp1 // if!(a!=b) goto Tmp1  
  
    sl     $vr3.s32 <- gcd.b,gcd.a  
    seq    $vr2.s32 <- $vr3.s32,0  
    btrue  $vr2.s32,gcd._gcdTmp4 // if!(a<b) goto Tmp4  
  
    mrk    2, 4 // Line number 4  
    sub    $vr4.s32 <- gcd.a,gcd.b  
    mov    gcd._gcdTmp2 <- $vr4.s32  
    mov    gcd.a <- gcd._gcdTmp2 // a = a - b  
    jmp    gcd._gcdTmp5  
gcd._gcdTmp4:  
    mrk    2, 6  
    sub    $vr5.s32 <- gcd.b,gcd.a  
    mov    gcd._gcdTmp3 <- $vr5.s32  
    mov    gcd.b <- gcd._gcdTmp3 // b = b - a  
gcd._gcdTmp5:  
    jmp    gcd._gcdTmp0  
  
gcd._gcdTmp1:  
    mrk    2, 8  
    ret    gcd.a // Return a
```

Register-Based IRs



Most common type of IR

Advantages:

- ▶ Better representation for register machines
- ▶ Dataflow is usually clear

Disadvantages:

- ▶ Slightly harder to synthesize from code
- ▶ Less compact
- ▶ More complicated to interpret

Optimization In Action

```
int gcd(int a, int b) {  
    while (a != b) {  
        if (a < b) b -= a;  
        else a -= b;  
    }  
    return a;  
}
```



GCC on SPARC

```
gcd:  save %sp, -112, %sp  
      st  %i0, [%fp+68]  
      st  %i1, [%fp+72]  
.LL2: ld  [%fp+68], %i1  
      ld  [%fp+72], %i0  
      cmp %i1, %i0  
      bne .LL4  
      nop  
      b   .LL3  
      nop  
.LL4: ld  [%fp+68], %i1  
      ld  [%fp+72], %i0  
      cmp %i1, %i0  
      bge .LL5  
      nop  
      ld  [%fp+72], %i0  
      ld  [%fp+68], %i1  
      sub %i0, %i1, %i0  
      st  %i0, [%fp+72]  
      b   .LL2  
      nop  
.LL5: ld  [%fp+68], %i0  
      ld  [%fp+72], %i1  
      sub %i0, %i1, %i0  
      st  %i0, [%fp+68]  
      b   .LL2  
      nop  
.LL3: ld  [%fp+68], %i0  
      ret  
      restore
```

GCC -O7 on SPARC

```
gcd:  cmp  %o0, %o1  
      be  .LL8  
      nop  
.LL9: bge,a .LL2  
      sub %o0, %o1, %o0  
      sub %o1, %o0, %o1  
.LL2: cmp  %o0, %o1  
      bne .LL9  
      nop  
.LL8: retl  
      nop
```

Typical Optimizations

- ▶ Folding constant expressions

$1+3 \rightarrow 4$

- ▶ Removing dead code

`if (0) { ... }` \rightarrow nothing

- ▶ Moving variables from memory to registers

```
ld    [%fp+68], %i1
```

```
sub   %i0, %i1, %i0  $\rightarrow$  sub   %o1, %o0, %o1
```

```
st    %i0, [%fp+72]
```

- ▶ Removing unnecessary data movement
- ▶ Filling branch delay slots (Pipelined RISC processors)
- ▶ Common subexpression elimination

Machine-Dependent vs. -Independent Optimization

No matter what the machine is, folding constants and eliminating dead code is always a good idea.

```
a = c + 5 + 3;  
if (0 + 3) {  
    b = c + 8;  
}
```

→ b = a = c + 8;

However, many optimizations are processor-specific:

- ▶ Register allocation depends on how many registers the machine has
- ▶ Not all processors have branch delay slots to fill
- ▶ Each processor's pipeline is a little different

Basic Blocks



```
int gcd(int a, int b) {  
    while (a != b) {  
        if (a < b) b -= a;  
        else a -= b;  
    }  
    return a;  
}
```

lower
→

```
A: sne t, a, b  
   bz E, t  
   slt t, a, b  
   bnz B, t  
   sub b, b, a  
   jmp C  
B: sub a, a, b  
C: jmp A  
E: ret a
```

split
→

```
A: sne t, a, b  
   bz E, t  
   slt t, a, b  
   bnz B, t  
   sub b, b, a  
   jmp C  
B: sub a, a, b  
C: jmp A  
E: ret a
```

The statements in a basic block all run if the first one does.

Starts with a statement following a conditional branch or is a branch target.

Usually ends with a control-transfer statement.

Control-Flow Graphs

A CFG illustrates the flow of control among basic blocks.

```
A:  
sne t, a, b  
bz E, t
```

```
slt t, a, b  
bnz B, t
```

```
sub b, b, a  
jmp C
```

```
B:  
sub a, a, b
```

```
C:  
jmp A
```

```
E:  
ret a
```

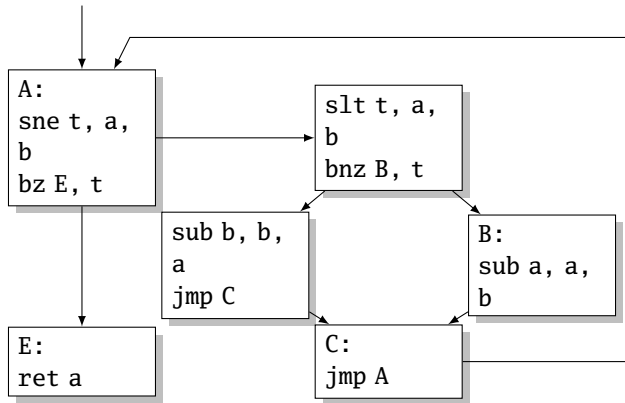

Separate Compilation and Linking

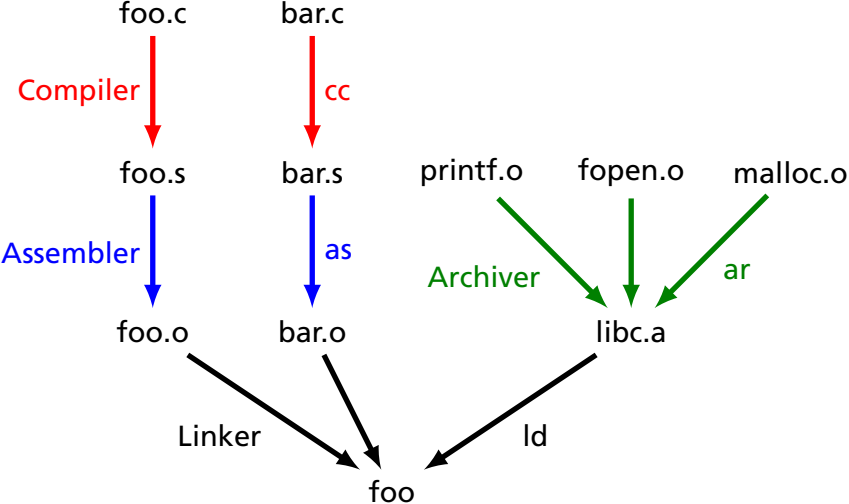

Linking



Goal of the linker is to combine the disparate pieces of the program into a coherent whole.

file1.c:

```
#include <stdio.h>
char a[] = "Hello";
extern void bar();

int main() {
    bar();
}

void baz(char *s) {
    printf("%s", s);
}
```

file2.c:

```
#include <stdio.h>
extern char a[];

static char b[6];

void bar() {
    strcpy(b, a);
    baz(b);
}
```

libc.a:

```
int
printf(char *s, ...)
{
    /* ... */
}

char *
strcpy(char *d,
        char *s)
{
    /* ... */
}
```

Linking



Goal of the linker is to combine the disparate pieces of the program into a coherent whole.

file1.c:

```
#include <stdio.h>
char a[] = "Hello";
extern void bar();
```

```
int main() {
    bar();
}
```

```
void baz(char *s) {
    printf("%s", s);
}
```

file2.c:

```
#include <stdio.h>
extern char a[];

static char b[6];
```

```
void bar() {
    strcpy(b, a);
    baz(b);
}
```

libc.a:

```
int
printf(char *s, ...)
{
    /* ... */
}
```

```
char *
strcpy(char *d,
        char *s)
{
    /* ... */
}
```

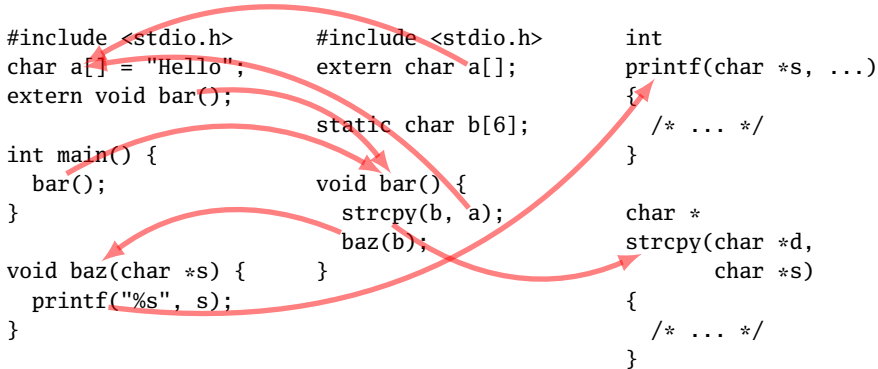

Linking

file1.o

a="Hello"

main()

baz()

file2.o

char b[6]

bar()

Linking

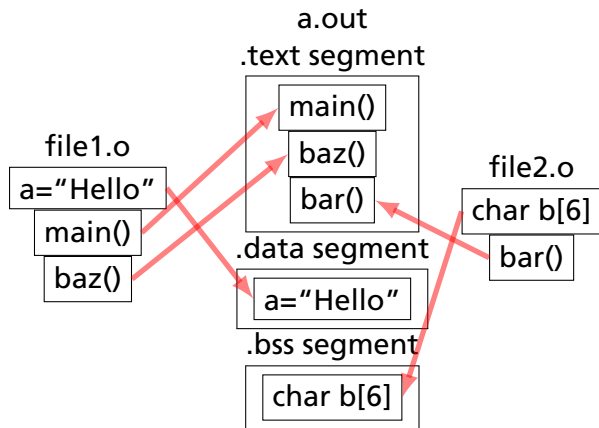

.text

Code of program

.data

Initialized data

.bss

Uninitialized data
"Block Started by
Symbol"

Object Files

Relocatable: Many need to be pasted together. Final in-memory address of code not known when program is compiled

Object files contain

- ▶ imported symbols (unresolved “external” symbols)
- ▶ relocation information (what needs to change)
- ▶ exported symbols (what other files may refer to)

Object Files

file1.c:

```
#include <stdio.h>
char a[] = "Hello";
extern void bar();

int main() {
    bar();
}

void baz(char *s) {
    printf("%s", s);
}
```

exported symbols

imported symbols

Object Files

file1.c:

```
#include <stdio.h>
char a[] = "Hello";
extern void bar();

int main() {
    bar();
}

void baz(char *s) {
    printf("%s", s);
}
```

```
# objdump -x file1.o
```

```
Sections:
```

Idx	Name	Size	VMA	LMA	Offset	Algn
0	.text	038	0	0	034	2**2
1	.data	008	0	0	070	2**3
2	.bss	000	0	0	078	2**0
3	.rodata	008	0	0	078	2**3

```
SYMBOL TABLE:
```

0000	g	0	.data	006	a
0000	g	F	.text	014	main
0000			*UND*	000	bar
0014	g	F	.text	024	baz
0000			*UND*	000	printf

```
RELOCATION RECORDS FOR [.text]:
```

OFFSET	TYPE	VALUE
0004	R_SPARC_WDISP30	bar
001c	R_SPARC_HI22	.rodata
0020	R_SPARC_LO10	.rodata
0028	R_SPARC_WDISP30	printf

Object Files

file1.c:

```
#include <stdio.h>
char a[] = "Hello";
extern void bar();

int main() {
    bar();
}

void baz(char *s) {
    printf("%s", s);
}
```

```
# objdump -d file1.o
0000 <main>:
    0: 9d e3 bf 90 save  %sp, -112, %sp
    4: 40 00 00 00 call  4 <main+0x4>
    4: R_SPARC_WDISP30 bar
    8: 01 00 00 00 nop
    c: 81 c7 e0 08 ret
   10: 81 e8 00 00 restore

0014 <baz>:
   14: 9d e3 bf 90 save  %sp, -112, %sp
   18: f0 27 a0 44 st  %i0, [ %fp + 0x44 ]
  1c: 11 00 00 00 sethi %hi(0), %o0
  1c: R_SPARC_HI22 .rodata
   20: 90 12 20 00 mov  %o0, %o0
  20: R_SPARC_LO10 .rodata
   24: d2 07 a0 44 ld  [ %fp + 0x44 ], %o1
   28: 40 00 00 00 call  28 <baz+0x14>
  28: R_SPARC_WDISP30 printf
  2c: 01 00 00 00 nop
  30: 81 c7 e0 08 ret
  34: 81 e8 00 00 restore
```

Before and After Linking

```
int main() {
    bar();
}

void baz(char *s) {
    printf("%s", s);
}
```

- ▶ Combine object files
- ▶ Relocate each function's code
- ▶ Resolve previously unresolved symbols

Code starting address changed

```
0000 <main>:
0: 9d e3 bf 90 save %sp, -112, %sp
4: 40 00 00 00 call 4 <main+0x4>
   4: R_SPARC_WDISP30 bar
8: 01 00 00 00 nop
c: 81 c7 e0 08 ret
10: 81 e8 00 00 restore
```

```
0014 <baz>:
14: 9d e3 bf 90 save %sp, -112, %sp
18: f0 27 a0 44 st %i0, [ %fp + 0x44 ]
1c: 11 00 00 00 sethi %hi(0), %o0
   1c: R_SPARC_HI22 .rodata
20: 90 12 20 00 mov %o0, %o0
   20: R_SPARC_LO10 .rodata
24: d2 07 a0 44 ld [ %fp + 0x44 ], %o1
28: 40 00 00 00 call 28 <baz+0x14>
   28: R_SPARC_WDISP30 printf
2c: 01 00 00 00 nop
30: 81 c7 e0 08 ret
34: 81 e8 00 00 restore
```

```
105f8 <main>:
105f8: 9d e3 bf 90 save %sp, -112, %sp
105fc: 40 00 00 0d call 10630 <bar>
10600: 01 00 00 00 nop
10604: 81 c7 e0 08 ret
10608: 81 e8 00 00 restore

1060c <baz>:
1060c: 9d e3 bf 90 save %sp, -112, %sp
10610: f0 27 a0 44 st %i0, [ %fp + 0x44 ]
10614: 11 00 00 41 sethi %hi(0x10400), %o0
10618: 90 12 23 00 or %o0, 0x300, %o0
1061c: d2 07 a0 44 ld [ %fp + 0x44 ], %o1
10620: 40 00 40 62 call 207a8
10624: 01 00 00 00 nop
10628: 81 c7 e0 08 ret
1062c: 81 e8 00 00 restore
```

Unresolved symbol

Linking Resolves Symbols

file1.c:

```
#include <stdio.h>
char a[] = "Hello";
extern void bar();

int main() {
    bar();
}

void baz(char *s) {
    printf("%s", s);
}
```

```
105f8 <main>:
105f8: 9d e3 bf 90 save %sp, -112, %sp
105fc: 40 00 00 0d call 10630 <bar>
10600: 01 00 00 00 nop
10604: 81 c7 e0 08 ret
10608: 81 e8 00 00 restore

1060c <baz>:
1060c: 9d e3 bf 90 save %sp, -112, %sp
10610: f0 27 a0 44 st %i0, [ %fp + 0x44 ]
10614: 11 00 00 41 sethi %hi(0x10400), %o0
10618: 90 12 23 00 or %o0, 0x300, %o0 ! "%s"
1061c: d2 07 a0 44 ld [ %fp + 0x44 ], %o1
10620: 40 00 40 62 call 207a8 ! printf
10624: 01 00 00 00 nop
10628: 81 c7 e0 08 ret
1062c: 81 e8 00 00 restore
```

file2.c:

```
#include <stdio.h>
extern char a[];

static char b[6];

void bar() {
    strcpy(b, a);
    baz(b);
}
```

```
10630 <bar>:
10630: 9d e3 bf 90 save %sp, -112, %sp
10634: 11 00 00 82 sethi %hi(0x20800), %o0
10638: 90 12 20 a8 or %o0, 0xa8, %o0 ! 208a8 <b>
1063c: 13 00 00 81 sethi %hi(0x20400), %o1
10640: 92 12 63 18 or %o1, 0x318, %o1 ! 20718 <a>
10644: 40 00 40 4d call 20778 ! strcpy
10648: 01 00 00 00 nop
1064c: 11 00 00 82 sethi %hi(0x20800), %o0
10650: 90 12 20 a8 or %o0, 0xa8, %o0 ! 208a8 <b>
10654: 7f ff ff ee call 1060c <baz>
10658: 01 00 00 00 nop
1065c: 81 c7 e0 08 ret
10660: 81 e8 00 00 restore
10664: 81 c3 e0 08 retl
10668: ae 03 c0 17 add %o7, %l7, %l7
```

Lambda Expressions

Function application written in prefix form. “Add four and five” is

(+ 4 5)

Evaluation: select a *redex* and evaluate it:

(+ (* 5 6) (* 8 3)) → (+ 30 (* 8 3))
→ (+ 30 24)
→ 54

Often more than one way to proceed:

(+ (* 5 6) (* 8 3)) → (+ (* 5 6) 24)
→ (+ 30 24)
→ 54

Simon Peyton Jones, *The Implementation of Functional Programming Languages*, Prentice-Hall, 1987.

Function Application and Currying



Function application is written as juxtaposition:

$$f\ x$$

Every function has exactly one argument.

Multiple-argument functions, e.g., $+$, are represented by *currying*, named after Haskell Brooks Curry (1900–1982). So,

$$(+\ x)$$

is the function that adds x to its argument.

Function application associates left-to-right:

$$\begin{aligned} (+\ 3\ 4) &= ((+\ 3)\ 4) \\ &\rightarrow 7 \end{aligned}$$

Lambda Abstraction

The only other thing in the lambda calculus is *lambda abstraction*: a notation for defining unnamed functions.

$(\lambda x . + x 1)$

(λ x . + x 1)
 \uparrow \uparrow \uparrow \uparrow \uparrow \uparrow
 That function of x that adds x to 1

The Syntax of the Lambda Calculus

```
expr ::= expr expr  
       |  $\lambda$  variable . expr  
       | constant  
       | variable  
       | (expr)
```

Constants are numbers and built-in functions;
variables are identifiers.

Beta-Reduction

Evaluation of a lambda abstraction—*beta-reduction*—is just substitution:

$$\begin{aligned}(\lambda x . + x 1) 4 &\rightarrow (+ 4 1) \\ &\rightarrow 5\end{aligned}$$

The argument may appear more than once

$$\begin{aligned}(\lambda x . + x x) 4 &\rightarrow (+ 4 4) \\ &\rightarrow 8\end{aligned}$$

or not at all

$$(\lambda x . 3) 5 \rightarrow 3$$

Free and Bound Variables

$$(\lambda x . + x y) 4$$

Here, x is like a function argument but y is like a global variable.

Technically, x occurs *bound* and y occurs *free* in

$$(\lambda x . + x y)$$

However, both x and y occur free in

$$(+ x y)$$

Beta-Reduction More Formally

$$(\lambda x . E) F \rightarrow_{\beta} E'$$

where E' is obtained from E by replacing every instance of x that appears free in E with F .

The definition of free and bound mean variables have scopes. Only the rightmost x appears free in

$$(\lambda x . + (- x 1)) x 3$$

so

$$\begin{aligned}(\lambda x . (\lambda x . + (- x 1)) x 3) 9 &\rightarrow (\lambda x . + (- x 1)) 9 3 \\ &\rightarrow + (- 9 1) 3 \\ &\rightarrow + 8 3 \\ &\rightarrow 11\end{aligned}$$

Alpha-Conversion

One way to confuse yourself less is to do α -conversion: renaming a λ argument and its bound variables.

Formal parameters are only names: they are correct if they are consistent.

$$\begin{aligned}(\lambda x . (\lambda x . + (- x 1)) x 3) 9 &\leftrightarrow (\lambda x . (\lambda y . + (- y 1)) x 3) 9 \\ &\rightarrow ((\lambda y . + (- y 1)) 9 3) \\ &\rightarrow (+ (- 9 1) 3) \\ &\rightarrow (+ 8 3) \\ &\rightarrow 11\end{aligned}$$

Beta-Abstraction and Eta-Conversion

Running β -reduction in reverse, leaving the “meaning” of a lambda expression unchanged, is called *beta abstraction*:

$$+ 4 1 \leftarrow (\lambda x . + x 1) 4$$

Eta-conversion is another type of conversion that leaves “meaning” unchanged:

$$(\lambda x . + 1 x) \leftrightarrow_{\eta} (+ 1)$$

Formally, if F is a function in which x does not occur free,

$$(\lambda x . F x) \leftrightarrow_{\eta} F$$

Reduction Order

The order in which you reduce things can matter.

$$(\lambda x . \lambda y . y) ((\lambda z . z z) (\lambda z . z z))$$

Two things can be reduced:

$$(\lambda z . z z) (\lambda z . z z)$$

$$(\lambda x . \lambda y . y) (\dots)$$

However,

$$(\lambda z . z z) (\lambda z . z z) \rightarrow (\lambda z . z z) (\lambda z . z z)$$

$$(\lambda x . \lambda y . y) (\dots) \rightarrow (\lambda y . y)$$

Normal Form

A lambda expression that cannot be β -reduced is in *normal form*. Thus,

$$\lambda y . y$$

is the normal form of

$$(\lambda x . \lambda y . y) ((\lambda z . z z) (\lambda z . z z))$$

Not everything has a normal form. E.g.,

$$(\lambda z . z z) (\lambda z . z z)$$

can only be reduced to itself, so it never produces an non-reducible expression.

Normal Form

Can a lambda expression have more than one normal form?

Church-Rosser Theorem I: If $E_1 \leftrightarrow E_2$, then there exists an expression E such that $E_1 \rightarrow E$ and $E_2 \rightarrow E$.

Corollary. No expression may have two distinct normal forms.

Proof. Assume E_1 and E_2 are distinct normal forms for E : $E \leftrightarrow E_1$ and $E \leftrightarrow E_2$. So $E_1 \leftrightarrow E_2$ and by the Church-Rosser Theorem I, there must exist an F such that $E_1 \rightarrow F$ and $E_2 \rightarrow F$. However, since E_1 and E_2 are in normal form, $E_1 = F = E_2$, a contradiction.

Normal-Order Reduction

Not all expressions have normal forms, but is there a reliable way to find the normal form if it exists?

Church-Rosser Theorem II: If $E_1 \rightarrow E_2$ and E_2 is in normal form, then there exists a *normal order* reduction sequence from E_1 to E_2 .

Normal order reduction: reduce the leftmost outermost redex.

Normal-Order Reduction

$$\left(\left(\lambda x . \left(\left(\lambda w . \left(\lambda z . + w z \right) 1 \right) \right) \left(\left(\lambda x . x x \right) \left(\lambda x . x x \right) \right) \right) \right) \left(\left(\lambda y . + y 1 \right) \left(+ 2 \right) \right)$$

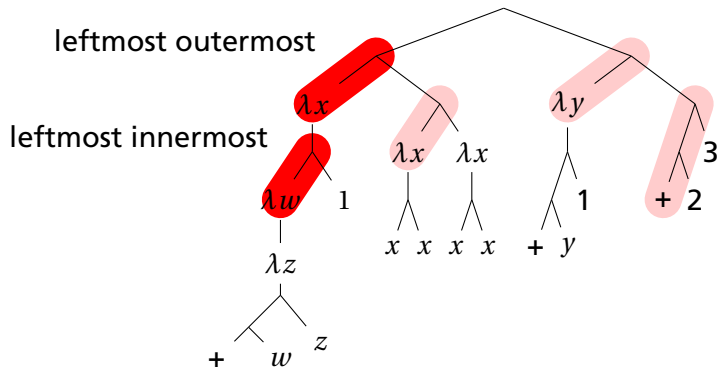

Recursion

Where is recursion in the lambda calculus?

$$FAC = \left(\lambda n . IF (= n 0) 1 \left(* n (FAC (- n 1)) \right) \right)$$

This does not work: functions are unnamed in the lambda calculus. But it is possible to express recursion *as a function*.

$$\begin{aligned} FAC &= (\lambda n . \dots FAC \dots) \\ &\leftarrow_{\beta} (\lambda f . (\lambda n . \dots f \dots)) FAC \\ &= H FAC \end{aligned}$$

That is, the factorial function, FAC , is a *fixed point* of the (non-recursive) function H :

$$H = \lambda f . \lambda n . IF (= n 0) 1 (* n (f (- n 1)))$$

Recursion

Let's invent a function Y that computes FAC from H , i.e.,
 $FAC = Y H$:

$$FAC = H FAC$$

$$Y H = H (Y H)$$

$$\begin{aligned} FAC\ 1 &= Y\ H\ 1 \\ &= H\ (Y\ H)\ 1 \\ &= (\lambda f . \lambda n . IF\ (= n\ 0)\ 1\ (*\ n\ (f\ (-\ n\ 1))))\ (Y\ H)\ 1 \\ &\rightarrow (\lambda n . IF\ (= n\ 0)\ 1\ (*\ n\ ((Y\ H)\ (-\ n\ 1))))\ 1 \\ &\rightarrow IF\ (= 1\ 0)\ 1\ (*\ 1\ ((Y\ H)\ (-\ 1\ 1))) \\ &\rightarrow * 1\ (Y\ H\ 0) \\ &= * 1\ (H\ (Y\ H)\ 0) \\ &= * 1\ ((\lambda f . \lambda n . IF\ (= n\ 0)\ 1\ (*\ n\ (f\ (-\ n\ 1))))\ (Y\ H)\ 0) \\ &\rightarrow * 1\ ((\lambda n . IF\ (= n\ 0)\ 1\ (*\ n\ (Y\ H\ (-\ n\ 1))))\ 0) \\ &\rightarrow * 1\ (IF\ (= 0\ 0)\ 1\ (*\ 0\ (Y\ H\ (-\ 0\ 1)))) \\ &\rightarrow * 1\ 1 \\ &\rightarrow 1 \end{aligned}$$

The Y Combinator

Here's the eye-popping part: Y can be a simple lambda expression.

$Y =$

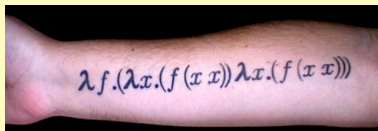

$= \lambda f . (\lambda x . f (x x)) (\lambda x . f (x x))$

$$\begin{aligned} Y H &= \left(\lambda f . (\lambda x . f (x x)) (\lambda x . f (x x)) \right) H \\ &\rightarrow (\lambda x . H (x x)) (\lambda x . H (x x)) \\ &\rightarrow H \left((\lambda x . H (x x)) (\lambda x . H (x x)) \right) \\ &\leftrightarrow H \left(\left(\lambda f . (\lambda x . f (x x)) (\lambda x . f (x x)) \right) H \right) \\ &= H (Y H) \end{aligned}$$

“Y: The function that takes a function f and returns $f(f(f(f(\dots))))$ ”

Prolog Execution

Facts

```
nerd(X) :- techer(X).  
techer(stephen).
```



Query

```
?- nerd(stephen).
```

→ Search (Execution)



Result

```
yes
```

Simple Searching

Starts with the query:

```
?- nerd(stephen).
```

Can we convince ourselves that `nerd(stephen)` is true given the facts we have?

```
techer(stephen).  
nerd(X) :- techer(X).
```

First says `techer(stephen)` is true. Not helpful.

Second says that we can conclude `nerd(X)` is true if we can conclude `techer(X)` is true. More promising.

Simple Searching

```
techer(stephen).  
nerd(X) :- techer(X).
```

```
?- nerd(stephen).
```

Unifying `nerd(stephen)` with the head of the second rule, `nerd(X)`, we conclude that $X = \text{stephen}$.

We're not done: for the rule to be true, we must find that all its conditions are true. $X = \text{stephen}$, so we want `techer(stephen)` to hold.

This is exactly the first clause in the database; we're satisfied. The query is simply true.

More Clever Searching

```
techer(stephen).  
techer(todd).  
nerd(X) :- techer(X).
```

```
?- nerd(X).
```

“Tell me about everybody who’s provably a nerd.”

As before, start with query. Rule only interesting thing.

Unifying `nerd(X)` with `nerd(X)` is vacuously true, so we need to establish `techer(X)`.

Unifying `techer(X)` with `techer(stephen)` succeeds, setting `X = stephen`, but we’re not done yet.

Unifying `techer(X)` with `techer(todd)` also succeeds, setting `X = todd`, but we’re still not done.

Unifying `techer(X)` with `nerd(X)` fails, returning `no`.

The Prolog Environment

Database consists of **Horn clauses**. (“If a is true and b is true and ... and y is true then z is true”.)

Each clause consists of **terms**, which may be **constants**, **variables**, or **structures**.

Constants: foo my_Const + 1.43

Variables: X Y Everybody My_var

Structures: rainy(rochester)
 teaches(edwards, cs4115)

Structures and Functors

A structure consists of a **functor** followed by an open parenthesis, a list of comma-separated terms, and a close parenthesis:

“Functor”

paren must follow immediately

```
bin_tree( foo, bin_tree(bar, glarch) )
```

What's a structure? Whatever you like.

A predicate `nerd(stephen)`

A relationship `teaches(edwards, cs4115)`

A data structure `bin(+, bin(-, 1, 3), 4)`

Unification

Part of the search procedure that matches patterns.

The search attempts to match a goal with a rule in the database by **unifying** them.

Recursive rules:

- ▶ A constant only unifies with itself
- ▶ Two structures unify if they have the same functor, the same number of arguments, and the corresponding arguments unify
- ▶ A variable unifies with anything but forces an equivalence

Unification Examples

The = operator checks whether two structures unify:

```
| ?- a = a.  
yes % Constant unifies with itself  
| ?- a = b.  
no % Mismatched constants  
| ?- 5.3 = a.  
no % Mismatched constants  
| ?- 5.3 = X.  
X = 5.3 ? ;  
yes % Variables unify  
| ?- foo(a,X) = foo(X,b).  
no % X=a required, but inconsistent  
| ?- foo(a,X) = foo(X,a).  
X = a % X=a is consistent  
yes  
| ?- foo(X,b) = foo(a,Y).  
X = a  
Y = b % X=a, then b=Y  
yes  
| ?- foo(X,a,X) = foo(b,a,c).  
no % X=b required, but inconsistent
```

The Searching Algorithm

```
search(goal  $g$ , variables  $e$ )
  for each clause  $h :- t_1, \dots, t_n$  in the database
     $e = \text{unify}(g, h, e)$ 
    if successful,
      for each term  $t_1, \dots, t_n$ 
         $e = \text{search}(t_k, e)$ 
      if all successful, return  $e$ 
  return no
```

in the order they appear

in the order they appear

Note: This pseudo-code ignores one very important part of the searching process!

Order Affects Efficiency

```
edge(a, b). edge(b, c).  
edge(c, d). edge(d, e).  
edge(b, e). edge(d, f).
```

```
path(X, X).
```

```
path(X, Y) :-  
    edge(X, Z), path(Z, Y).
```

Consider the query

```
| ?- path(a, a).
```

```
path(a,a)  
  |  
path(a,a)=path(X,X)  
  |  
  X=a  
  |  
  yes
```

Good programming practice: Put the easily-satisfied clauses first.

Order Affects Efficiency

```
edge(a, b). edge(b, c).  
edge(c, d). edge(d, e).  
edge(b, e). edge(d, f).  
  
path(X, Y) :-  
    edge(X, Z), path(Z, Y).  
  
path(X, X).
```

Consider the query

```
| ?- path(a, a).
```

Will eventually produce
the right answer, but
will spend much more
time doing so.

```
path(a,a)  
  |  
path(a,a)=path(X,Y)  
  |  
X=a Y=a  
  |  
edge(a,Z)  
  |  
edge(a,Z) = edge(a,b)  
  |  
Z=b  
  |  
path(b,a)  
  |  
  ⋮
```

Order Can Cause Infinite Recursion

```
edge(a, b). edge(b, c).  
edge(c, d). edge(d, e).  
edge(b, e). edge(d, f).  
  
path(X, Y) :-  
    path(X, Z), edge(Z, Y).  
  
path(X, X).
```

Consider the query

```
| ?- path(a, a).
```

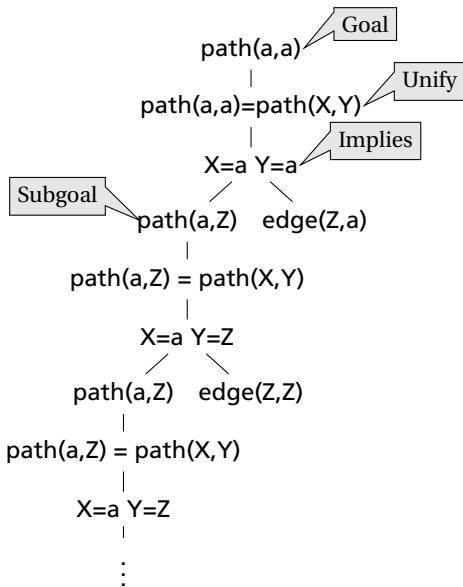

Prolog as an Imperative Language

A declarative statement such as

```
P if Q and R and S
```

can also be interpreted procedurally as

```
To solve P, solve Q, then R, then S.
```

This is the problem with the last path example.

```
path(X, Y) :-  
    path(X, Z), edge(Z, Y).
```

“To solve P, solve P...”

```
go :- print(hello_),  
      print(world).
```

```
| ?- go.  
hello_world  
yes
```

Cuts

Ways to shape the behavior of the search:

- ▶ Modify clause and term order.
Can affect efficiency, termination.
- ▶ “Cuts”
Explicitly forbidding further backtracking.

When the search reaches a cut (!), it does no more backtracking.

```
techer(stephen) :- !.  
techer(todd).  
nerd(X) :- techer(X).
```

```
| ?- nerd(X).
```

```
X = stephen
```

```
yes
```



Processes and Threads

Process

Separate address space

Explicit inter-process communication

Synchronization part of communication

Operating system calls:
`fork()`, `wait()`

Thread

Shared address spaces

Separate PC and stacks

Communication is through shared memory

Synchronization done explicitly

Library calls, e.g., `pthread`s

Dot Product

```
#include <stdio.h>

int main()
{
    double a[256], b[256], sum;
    int i, n = 256;

    for (i = 0 ; i < n ; i++) {
        a[i] = i * 0.5;
        b[i] = i * 2.0;
    }

    sum = 0.0;

    for (i = 0 ; i < n ; i++ )
        sum += a[i]*b[i];

    printf("sum = %f\n", sum);
    return 0;
}
```

Dot Product

```
#include <omp.h>
#include <stdio.h>

int main()
{
    double a[256], b[256], sum;
    int i, n = 256;

    for (i = 0 ; i < n ; i++) {
        a[i] = i * 0.5;
        b[i] = i * 2.0;
    }

    sum = 0.0;
    #pragma omp parallel for reduction(+:sum)
    for (i = 0 ; i < n ; i++ )
        sum += a[i]*b[i];

    printf("sum = %f\n", sum);
    return 0;
}
```

OpenMP version

```
gcc -fopenmp -o dot dot.c
```

OpenMP pragma tells the compiler to

- ▶ Execute the loop's iterations in parallel (multiple threads)
- ▶ Sum each thread's results

What's going on?

```
#include <omp.h>
#include <stdio.h>

int main() {
    int i, n = 16;

    # pragma omp parallel for \
        shared(n) private(i)
    for (i = 0 ; i < n ; i++)
        printf("%d: %d\n",
            omp_get_thread_num(), i);

    return 0;
}
```

"parallel for": Split for loop iterations into multiple threads

"shared(n)": Share variable n across threads

"private(i)": Each thread has a separate i variable

Run 1	Run 2	Run 3
1: 4	3: 12	0: 0
1: 5	3: 13	0: 1
1: 6	3: 14	0: 2
1: 7	3: 15	0: 3
2: 8	1: 4	3: 12
2: 9	1: 5	3: 13
2: 10	1: 6	3: 14
2: 11	1: 7	3: 15
0: 0	2: 8	1: 4
3: 12	2: 9	1: 5
3: 13	2: 10	1: 6
3: 14	2: 11	1: 7
3: 15	0: 0	2: 8
0: 1	0: 1	2: 9
0: 2	0: 2	2: 10
0: 3	0: 3	2: 11

Fork-Join Task Model

Spawn tasks in parallel, run each to completion, collect the results.

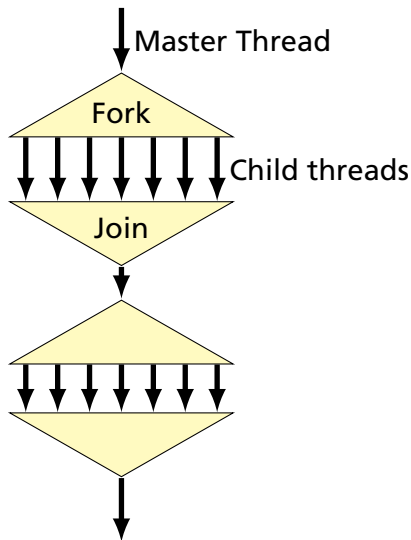

Parallel Regions

```
#include <omp.h>
#include <stdio.h>

int main()
{
    # pragma omp parallel
    { /* Fork threads */

        printf("This is thread %d\n",
               omp_get_thread_num());

    } /* Join */

    printf("Done.\n");

    return 0;
}
```

```
$ ./parallel
This is thread 1
This is thread 3
This is thread 2
This is thread 0
Done.
$ ./parallel
This is thread 2
This is thread 1
This is thread 3
This is thread 0
Done.
$ OMP_NUM_THREADS=8 ./parallel
This is thread 0
This is thread 4
This is thread 1
This is thread 5
This is thread 3
This is thread 6
This is thread 2
This is thread 7
Done.
```

Work Sharing: For Construct

```
#include <omp.h>
#include <stdio.h>

int main()
{
    int i;
    # pragma omp parallel
    {
        # pragma omp for
        for (i = 0 ; i < 8 ; i++)
            printf("A %d[%d]\n",
                omp_get_thread_num(), i);
        # pragma omp for
        for (i = 0 ; i < 8 ; i++)
            printf("B %d[%d]\n",
                omp_get_thread_num(), i);
    }

    return 0;
}
```

```
$ ./for
A 3[6]
A 3[7]
A 0[0]
A 0[1]
A 2[4]
A 2[5]
A 1[2]
A 1[3]
B 1[2]
B 1[3]
B 0[0]
B 0[1]
B 3[6]
B 3[7]
B 2[4]
B 2[5]
```

Work Sharing: Nested Loops

Outer loop's index private by default. Inner loop's index must be set private.

```
#include <omp.h>
#include <stdio.h>

int main()
{
    int i, j;
    # pragma omp parallel for private(j)
        for (i = 0 ; i < 4 ; i++)
            for (j = 0 ; j < 2 ; j++)
                printf("A %d[%d,%d]\n",
                    omp_get_thread_num(), i, j);

    return 0;
}
```

```
p$ ./for-nested
```

```
A 3[3,0]
A 3[3,1]
A 1[1,0]
A 1[1,1]
A 2[2,0]
A 2[2,1]
A 0[0,0]
A 0[0,1]
```

```
$ ./for-nested
```

```
A 3[3,0]
A 3[3,1]
A 1[1,0]
A 1[1,1]
A 0[0,0]
A 0[0,1]
A 2[2,0]
A 2[2,1]
```

Summing a Vector: Critical regions

```
#pragma omp parallel for
for (i = 0 ; i < N ; i++)
    sum += a[i]; // RACE: sum is shared
```

```
int main()
{
    double sum = 0.0, local, a[10];
    int i;
    for ( i = 0 ; i < 10 ; i++)
        a[i] = i * 3.5;
    # pragma omp parallel \
        shared(a, sum) private(local)
    {
        local = 0.0;
        # pragma omp for
        for (i = 0 ; i < 10 ; i++)
            local += a[i];
        # pragma omp critical
        { sum += local; }
    }
    printf("%g\n", sum);
    return 0;
}
```

Without the critical directive:

```
$ ./sum
157.5
$ ./sum
73.5
```

With #pragma omp critical:

```
$ ./sum
157.5
$ ./sum
157.5
```

Summing a Vector: Reduction

```
#include <omp.h>
#include <stdio.h>

int main()
{
    double sum = 0.0, a[10];
    int i;
    for ( i = 0 ; i < 10 ; i++)
        a[i] = i * 3.5;

    # pragma omp parallel \
        shared(a) reduction(+:sum)
    {
        # pragma omp for
        for (i = 0 ; i < 10 ; i++)
            sum += a[i];
    }

    printf("%g\n", sum);
    return 0;
}
```

```
$ ./sum-reduction
157.5
```

Barriers

```
#include <omp.h>
#include <stdio.h>

int main()
{
    int x = 2;
    #pragma omp parallel shared(x)
    {
        int tid = omp_get_thread_num();
        if (tid == 0)
            x = 5;
        else
            printf("A: th %d: x=%d\n",
                tid, x);
    }
    #pragma omp barrier

    printf("B: th %d: x=%d\n",
        tid, x);
}
return 0;
}
```

```
$ ./barrier
```

```
A: th 2: x=2
```

```
A: th 3: x=2
```

```
A: th 1: x=2
```

```
B: th 1: x=5
```

```
B: th 0: x=5
```

```
B: th 2: x=5
```

```
B: th 3: x=5
```

Old value of x

```
$ ./barrier
```

```
A: th 2: x=2
```

```
A: th 3: x=5
```

```
A: th 1: x=2
```

```
B: th 1: x=5
```

```
B: th 2: x=5
```

```
B: th 3: x=5
```

```
B: th 0: x=5
```

New value of x